



CHAPTER
13

TRANSPORTATION
AND SERVICES

*Ngā Pūtahitanga-ā-Waka me
Ngā Ratonga*

13 Transportation and Services

This Chapter applies to all subdivision and land use activities.

13.1 OBJECTIVES AND POLICIES

Transportation

Objective TS1

A safe, efficient, sustainable integrated land transport network.

- Policy 1 To consider benefits derived from improved transport infrastructure and connectivity and to ensure that any adverse effects on the physical transportation network resources are avoided, remedied or mitigated.
- Policy 2 To ensure that adverse effects on traffic movement, safety, sustainability, network capacity and the environment from the location, construction, maintenance and operation of activities are avoided, remedied or mitigated.
- Policy 3 To ensure the transportation mitigation meets the demands of the activity while maintaining the safe, sustainable and efficient function of the transport network.
- Policy 4 To ensure that land development occurs in an integrated, co-ordinated and comprehensive manner that does not compromise the overall purpose of the multi model transport network, particularly pedestrian and cycleways.
- Policy 5 To ensure that activities do not adversely affect the function, including the safe and efficient operation, of the transport network.
- Policy 6 To give priority to the safe movement of cyclists and pedestrians within the Business Centre Zone.
- Policy 7 To provide a connected road, cyclist and pedestrian network and where necessary physically separate vehicle, cyclist and pedestrian movements.
- Policy 8 To encourage an effective and efficient functioning of the transport network, ensuring that the ease of movement for pedestrians, cyclists, disabled people, the elderly, children, motor vehicles, and public transport is not unduly compromised.

Objective TS2

Roads that are safe for all road users and designed to the context of their environment.

- Policy 1 To ensure that transportation networks are planned to respond to the land use context using design to encourage appropriate traffic speeds and provide amenity for all users.
- Policy 2 To ensure that the street network enables traffic to flow freely and is appropriate for its purpose, and promotes safety of all users.
- Policy 3 To encourage and facilitate sustainable modes of transport including walking, cycling and public transport.

Objective TS3

Roads should be capable of carrying all utility services underground, provide for the management of stormwater, and contribute to quality urban design.

- Policy 1 The road reserve shall allow for an integrated approach to the provision of

infrastructure services and streetscape planting avoiding unnecessary disturbance and costs.

Objective TS4 *The safe movement of traffic and pedestrians entering, leaving and within sites.*

Policy 1 To ensure sufficient and practical provision of safe on-site parking, manoeuvring areas, connectivity and access and pedestrian connectivity.

Policy 2 To avoid poorly located and inadequately constructed access points on to roads and/or across rail lines.

Objective TS5 *Prevent uncontrolled or unauthorised disposal of stormwater, wastewater and sewage into the environment.*

Policy 1 To ensure stormwater, sewage and other wastewater is detained, collected or removed from a lot or a site without causing an adverse effect on the natural environment or on other property, or to people.

Policy 2 To encourage where practicable the use of low impact design and retention based stormwater solutions for the treatment and disposal of stormwater.

Policy 3 To ensure that stormwater and floodwater is managed in accordance with catchment management plans and discharge consents.

Policy 4 To enable subdivision and development of residential land when it is, or will be serviced to a standard compatible with existing residential areas.

Objective TS6 *Urban areas are appropriately and adequately supplied with potable water.*

Policy 1 To manage the use of water resources in a manner that enables people and communities to provide for their social economic and cultural well-being and their health and safety.

Policy 2 To avoid, remedy or mitigate potential adverse effects on water quality and quantity, due to the inappropriate location and management of activities.

Policy 3 To encourage water conservation.

13.2 RULES

The following standards and terms apply to permitted, controlled, and restricted discretionary activities and will be used as a guide for discretionary and non-complying activities.

13.2.1 Activity Status Table

P = Permitted
C = Controlled
RD = Restricted Discretionary
D = Discretionary
NC = Non-Complying
Pr = Prohibited

Item	Activity Status	All Zones
1.	Public roads (new) excluding those approved as part of a resource consent for subdivision;	D

Item	Activity Status	All Zones
	Public Service lanes (new) excluding those approved as part of a resource consent for subdivision;	D
	Public car-parks (new) excluding those approved as part of a resource consent for subdivision;	D
2.	Rail network or line and/or ancillary equipment.	D
3.	Airports and associated buildings and/or structures.	D
4.	Heliports and associated buildings and/or structures.	D

Advice Note 1: Requiring authorities also have the ability to designate roads.

Advice Note 2: The roading hierarchy is defined in Appendix 22.8.

13.2.2 Roads and Property Access (excluding State Highway)

13.2.2.1 Any new road or **accessway** shall be designed, constructed and located to accommodate the volume and type of traffic likely to use it in a safe and efficient manner.

13.2.2.2 Compliance with the following standards shall satisfy Rule 13.2.2.1. Non-compliance with these standards shall be considered a Restricted Discretionary activity:

- a. Roads and **accessways** shall be designed to meet the design standards set out in Appendix 13.7.5. Widths shall be selected to ensure that adequate movement lanes, footpaths, berms, and batters can be provided to retain amenity values (including landscaping) and enable utility services to be provided safely and in economical and accessible locations;
- b. All components of the transportation network shall have a minimum design life of 25 years;
- c. No road or **accessway** shall have a gradient steeper than 1 in 8 (12.5%) measured over a distance not less than 20m;
- d. No road or **accessway** shall have a gradient flatter than 1 in 200 (0.5%) measured over a distance not less than 20m;
- e. Where roadside **batters** steeper than 1 in 3 are to be constructed, the road reserve boundary shall encapsulate the batter and provide not less than one metre clearance from the top or toe of the batter, as appropriate;
- f. No part of a road or **accessway** shall cause, or be located into land which is unstable, or with unsuitable ground conditions;
- g. All roads and **accessways** shall be located, designed, constructed and enable **maintenance** to;
 - i. provide vehicular and pedestrian access to every **lot** relying on its construction for frontage purposes;
 - ii. provide for stormwater collection and/or disposal that shall comply with the Rules in 13.2.28 (**Stormwater**);
 - iii. manage **flood waters**; and
- h. All new road **intersections** shall be a minimum distance as set out below from any other intersection, where the speed shown relates to the road with highest speed;

Advice Note 1: Sight distances relating to level crossing are listed under Rule 13.2.22. .

Speed Environment (km/hr)	Minimum Separation Distance centre to centreline (m)
100	800
80	550
70	220
60	160
50	125

Table 13:1 Separation Distances

- i. Where new public/**private roads**, roadways (including **access legs**, **access lots**, **right of ways**, **privateroadways**) or vehicle crossings are proposed the minimum sight distances prescribed below shall apply;

Speed Environment (through road) (Km/hr)	Minimum Sight Distance	
	Collector	Arterial
100	160	250
90	130	210
80	105	175
70	85	140
60	65	115
50	45	90
<40	35	70

Table 13:2 Minimum Sight Distances

Advice Note: The roading hierarchy is defined in Appendix 22.8.

- j. The minimum vehicle crossing separation distances to an intersection shall be;

Zone	Distance
Rural Coastal, Rural Foothills, Rural Plains, Rural Ōhiwa, Deferred Residential Zone	50 metres
Residential or Urban Living Zone	15 metres for a residential activity 30 metres for a business activity
Business Centre, Commercial, Large Format Retail, Education, Mixed Use, Airport, Light Industrial and Industrial Zone	30 metres
Reserve, CPZ	As above dependent on the predominant zoning of land adjacent to the Reserve or CPZ .

Table 13:3 Minimum Vehicle Crossing Separation

Advice Note: These distances are to be measured from the intersection of the two kerb lines of the adjacent intersection.

- 13.2.2.3 All new road intersections or **accessways** shall be a minimum distance of 30m from the closest rail track.
- 13.2.2.4 Each site or **lot** shall be provided with legal access for a vehicle from a formed legal road or by mutual right of way service lane (which provides vehicle access to a formed legal road). The access shall be located and formed in accordance with this rule, provided that this rule shall not apply to a site or a lot on Ōhākana Island.
- 13.2.2.5 All subdivision shall provide road and/or pedestrian connections between the lands being subdivided, existing roads, adjoining properties and balance lots.

- 13.2.2.6 Provision should be made for road reserves to satisfactorily accommodate reticulated **network utility services**, **street lighting**, **pedestrian traffic**, cyclists and amenity landscaping including street trees.
- 13.2.2.7 The design shall provide connectivity with and between neighbourhoods for cycle, pedestrian and vehicle transport modes as appropriate to the scale of the subdivision.
- 13.2.2.8 Road lighting shall be provided to ensure and enable the safe and efficient movement of vehicles and pedestrians within the road network at night.

Advice Note: Within the Rural zones street lighting will be limited to areas where additional vehicular safety is required. For example: intersections and places of assembly such as **Marae** and community facilities.

13.2.3 Streetscape Planting – New Urban Roads

- 13.2.3.1 All new roads shall include streetscape planting appropriate for the street hierarchy.
- 13.2.3.2 Any development that proposes construction of an entrance feature shall require that feature to be located within private property and **maintenance** shall be the responsibility of that property owner.
- 13.2.3.3 Any area not required for the carriageway or for the footpath area shall be finished in a grassed surface unless otherwise provided for in this District Plan.
- 13.2.3.4 Street gardens shall be limited to arterials, collector roads, or within median strips and roundabouts. Any proposed gardens not in medians or roundabouts shall be a minimum of 45m² in planted area.
- 13.2.3.5 Planting in the road reserve shall not interfere with clear lines of sight.
- 13.2.3.6 For new roads street trees shall be required at no more than 1 tree per 6 lineal metres of road, and no less than 1 tree per 15 lineal metre.
- 13.2.3.7 Any plants or tree species shall be appropriate to the road hierarchy and location
- 13.2.3.8 Any tree or garden planted in the road reserve shall be clear of utilities and services and shall be easily maintained. This will include the use of tree pits and root barriers as necessary.

Advice Note: Council will keep a schedule of appropriate species.

13.2.4 Design and Construction of Private ways, Access Legs, Access Lots or Common Areas Utilised for Vehicle Access on a Cross or Company Lease or Unit Title

- 13.2.4.1 A **private way**, access leg, access lot or common area utilised for vehicle access on a cross or company lease or unit title shall be designed, formed and constructed in accordance with the Urban Private Accessway Requirements or Rural Private Accessway Requirements set out below.

Urban Accessway Requirements						
No of Lots or Dwellings Served	Land Use	Min. Width of Access (m)	Max. Length of Access (m)	Min. Width of Carriageway (m)	Berms (m)	Surface Standard
1	Residential activity	3.0	60	2.5	0.5	Standard Drawing 13
1	Business activity	6.0	60	5.0	0.5 & 0.5	Specific design
2 or 3	Residential activity	4.0	60	3.0	0.5 & 0.5	Standard Drawing 13
2 or 3	Business activity	8.0	120	6.0	0.5 & 1.5	Specific design

Urban Accessway Requirements						
No of Lots or Dwellings Served	Land Use	Min. Width of Access (m)	Max. Length of Access (m)	Min. Width of Carriageway (m)	Berms (m)	Surface Standard
4 - 6	Residential activity	6.0	60	5.0	0.5 & 0.5	Standard Drawing 13
4 - 6	Business activity	12.0	150	8.0	2.0 & 2.0	Specific design

Table 13:4 Urban Private Accessway Requirements

- 13.2.4.2 For subdivisions of seven or more lots, the road standards shall apply.
- 13.2.4.3 Where the subdivision is of seven or more lots, the acceptance of the road as a private way if required by the Developer shall be at the Council's discretion.
- 13.2.4.4 For subdivisions of up to six lots where the land use is for commercial or industrial activities, the accessway and carriageway widths will be subject to specific approval by the Council.
- 13.2.4.5 Streetlights may be required on private accessways at the discretion of the Council, subject to length and layout.
- 13.2.4.6 Urban private accessways shall be constructed in accordance with the details shown on Standard Drawing R13.
- 13.2.4.7 Where Option A or B is used for surfacing as set out on Standard Drawing R13, a pavement design in accordance with Austroads may be required depending on the in-situ sub-base material.
- 13.2.4.8 Bridges shall have a minimum width of 3.5m between kerbs and shall have a design loading of 0.85 HN 72.
- 13.2.4.9 The maximum length of an accessway as set out in Rule 13.2.4.1 may only be exceeded with the specific approval of Council.
- 13.2.4.10 Accessway width shall be determined by the greater of the number of lots or the number of dwellings to be served.

Rural Accessway Requirements					
No of Lots Served	Land Use	Min. Width of Access (m)	Max. Length of Access (m)*	Min. Width of Carriageway (m)	Surface Standard
1	Residential activity only where area is 1ha or less	5.0	750	3.5	All weather metal
1	Other activities and in all cases where area > 1ha	8.0	750	3.5	All weather metal
2 - 4	All	9.0	750	5.0	All weather metal
5 - 8	All	10.0	750	5.0	Seal coat

Table 13:5 Rural Accessway Requirements

- 13.2.4.11 For subdivisions of nine or more lots, the road standards shall apply.
- 13.2.4.12 *Applies in Rural Plains Zone only
- 13.2.4.13 Bridges shall have a minimum width of 3.5m between kerbs and shall have a design loading of 0.85 HN HO72.

13.2.4.14 Non-compliance with Rule 13.2.4.1 shall be assessed as a Restricted Discretionary activity.

Advice Note: A seal coat is recommended for private access way serving 2 – 4 lots.

13.2.5 Design and Construction of Vehicle Crossings (excluding State Highways)

13.2.5.1 Safe and efficient vehicular access to a formed legal road (either direct access by vehicle crossing or via a private way, right of way, access leg) shall be provided for every new lot or development, or for a development which results in a change in the character, intensity or scale of activity. The access shall meet, or be upgraded to meet, the requirements of the transportation performance standards set out in Section 13.2 below.

13.2.5.2 A vehicle crossing shall be located, designed, constructed and maintained to ensure that all traffic movements can be undertaken safely with consideration being given to likely traffic volumes, vehicle speeds, appropriate sight distances, safe stopping distances, pedestrian or cycling conflicts, and anticipated life expectancy. Such crossing shall be designed, located and constructed in accordance with drawings R08, R09, R25, R28, R29 or R30 (Appendix 13.7.1 and 13.7.5) as appropriate.

13.2.5.3 A vehicle entranceway or crossing shall be designed, constructed and maintained to ensure that;

- it is able to be used in all weather conditions;
- it will have no adverse impact on the roadside drainage system;
- stormwater and detritus (including gravel and silt) do not migrate into the road pavement;
- it is able to carry the volume and weight of traffic likely to use the entranceway or crossing;
- it is constructed to the same standard as the adjacent road (unless the volume, type and mix of traffic generated to and from the site warrants a different standard); and
- all work on crossings within the road boundaries shall be undertaken at the expense of the developer.

13.2.5.4 A crossing from a road carriageway to a site or lot shall serve a maximum of:

Zone	Number of Lots
Residential or Urban Living Zone	Six lots
Rural Coastal, Rural Foothills, Rural Plains, Rural Ōhiwa, Deferred Residential Zone	Eight lots
Business Centre, Commercial, Large Format Retail, Education, Mixed Use, Airport, Light Industrial and Industrial Zone	Six lots

Table 13.6 Crossings from a Road Carriageway

13.2.5.5 Non-compliance with Rule 13.2.5 shall be assessed as a Discretionary activity.

13.2.6 Design and Construction of Vehicle Crossings on a State Highway

13.2.6.1 Where a new vehicle crossing (or crossings) is proposed onto a State Highway, written consent from the New Zealand Transport Agency shall be provided.

Advice Note: Design specifications will be dependent on the type or volume of traffic using the access way and the volume of traffic using the state highway.

13.2.6.2 Non-compliance with Rule 13.2.6.1 shall be assessed as a Restricted Discretionary Activity (see criteria in 13.4.11).

13.2.7 Traffic Flow Generation

- 13.2.7.1 Any activity in the Residential and Urban Living Zones that is likely to generate more than 25 **car-equivalent movements** per day shall be a Discretionary activity (see Criteria in 13.4.7).
- 13.2.7.2 Any activity in the Business Centre, Mixed Use and Commercial Zone which provides more than 25 **on-site parking spaces** shall be a discretionary activity.
- 13.2.7.3 Any new land use activity that increases the use of an existing direct access from the State Highway by more than 50 **car equivalent movements** per day shall be a Restricted Discretionary Activity.

13.2.8 Pedestrian Streets – (Business Centre and Commercial Zone)

- 13.2.8.1 No activity on a site which adjoins a public footpath along a Pedestrian Street in the Business Centre Zone, shown on any planning map, shall have **direct vehicular access to that street other than by a public service lane** or an existing vehicle crossing provided that this does not apply to the pedestrian frontage at the Taneātua Commercial Zone
- 13.2.8.2 Non-compliance with this Rule 13.2.8.1 shall be assessed as a Restricted Discretionary activity (see Criteria in 13.4.7 and 13.4.8).

13.2.9 *Deleted as per updates on 17 December 2021 - Removal of minimum parking requirements as per National Policy Statement on Urban Development 2020 (section 3.38).*

13.2.10 Location and Design of Parking Areas

- 13.2.10.1 The layout of any parking area is to be practical so that vehicles can manoeuvre into nominated parking spaces without the need to;
- a. travel over any other parking space;
 - b. reverse-manoevr e either onto or off a site; provided a vehicle may reverse-manoevr e from a site in the following circumstances;
 - i. the access serves only one **dwelling** or one **accessory building for habitation**;
 - ii. access from the parking area is on to a Local Road as defined in Appendix 22.8 (Roading Hierarchy) with a posted speed limit of 50km/hour or less; and
 - iii. access is not from a rear site.
 - c. undertake more than one reverse-manoevr e when manoeuvring out of any parking or **loading space**;
 - d. reverse-manoevr e when moving from any vehicle access to any required parking space; and
 - e. travel over a nominated outdoor living space.
- 13.2.10.2 Parking spaces are to have sufficient width and depth to enable the parking of a vehicle without any part **extending into a manoeuvring area, accessway**, over a boundary of the **lot** or into a common vehicle area (right-of-way, **service lane**, and common area for a cross-lease). A manoeuvring area shall include any part of the site that is used by vehicles to move from the access point to any parking or **loading space** and includes all driveways and aisles, and may be part of an **accessway**. Compliance with AS/NZS 2890:1:2004 shall satisfy this rule (See Appendix 13.7.2).
- 13.2.10.3 In the Residential and the Urban Living Zones, no car park space shall be located in the front yard.

- 13.2.11 *Deleted as per updates on 17 December 2021 - Removal of minimum parking requirements as per National Policy Statement on Urban Development 2020 (section 3.38).*
- 13.2.12 *Assessing Deleted as per updates on 17 December 2021 - Removal of minimum parking requirements as per National Policy Statement on Urban Development 2020 (section 3.38).*
- 13.2.13 **Service Lane or Roads**
- 13.2.13.1 All parking spaces and manoeuvring areas shall be provided on-site, exclusive of land shown to be acquired for a service lane or road.
- 13.2.14 **Construction of Parking Spaces, Access and Manoeuvring Areas**
- 13.2.14.1 All parking spaces, access and manoeuvring areas shall be formed, constructed and maintained so as not to create a dust nuisance or permit vehicles to carry deleterious material such as mud, stone, chip or gravel on to a public street or road or footpath.
- 13.2.14.2 A two-coat sealed standard of construction with stormwater control or better, shall meet the requirements of this rule in a business zone or for a **business activity** in another zone. However, in the Community and Cultural Zone, parking areas are permitted to be constructed with gobi-blocks, or similar material, techniques or methods that will ensure the carpark is able to be used for parking in all weather, avoiding tracking dirt on to any public road.
- 13.2.14.3 Non-compliance with the rules in 13.2.14 shall be a Restricted Discretionary activity (see Criteria in 13.4.10).
- 13.2.15 **Restricted vehicle access to Parking Spaces**
- 13.2.15.1 Vehicle access to parking spaces shall be assessed as a Restricted Discretionary activity where located within a **Restricted vehicle access** as shown on the Planning Maps.
- 13.2.15.2 Non-compliance with Rule 13.2.15.1 shall be a Restricted Discretionary activity (see Criteria in 13.4.7).
- 13.2.16 **Whakatāne Riverbank Reserve**
- 13.2.16.1 Any activity which requires more than five car-park spaces to be provided on-site within the Whakatāne Riverbank Reserve shall be a Discretionary activity.
- 13.2.17 **Alternatives to On-Site Parking for Activities in a Business Centre, Commercial, Light Industrial or Industrial Zone**
- 13.2.17.1 On-site vehicle parking and parking buildings associated with a Permitted or Controlled activity in a Business Centre, Commercial, Light Industrial or Industrial Zone may be located in an adjoining site, off-street vehicle parking associated with any other activity, and shall be a Controlled activity.
- 13.2.18 **Provision of Loading spaces**
- 13.2.18.1 Every person who proposes to erect, re-erect, construct or re-construct a **building**, shall provide within the site suitable and efficient accommodation for any loading or fuelling of vehicles which is likely to arise from the use of the **building**.
- 13.2.18.2 The provision of **loading space** in respect of any site may be made as part of the side and/or rear yard

space, but not front yard space of that site.

13.2.18.3 The method of loading shall at no time cause the footpath or access to adjacent properties to be blocked, nor shall it create a traffic hazard on the road.

13.2.18.4 All loading and unloading of stock, bulk produce, or other farm produce, fertiliser or similar goods or materials for rural use shall be carried out off the road reserve and no vehicles shall stand on any part of the road reserve while loading or unloading or cause any obstruction to visibility for traffic using the road.

13.2.18.5 Non-compliance with the Rules in 13.2.18 shall be a Restricted Discretionary activity (see Criteria in 13.4.10).

13.2.19 Construction of Loading spaces

13.2.19.1 All loading spaces provided in accordance with this rule shall be formed, constructed and maintained so as not to create a dust nuisance or permit vehicles to carry deleterious material such as mud, stone, chip or gravel on to a public street or road or footpath.

13.2.19.2 A two-coat sealed standard of construction with stormwater control or better shall meet the requirements of this rule in a business zone or for a **business activity** in another zone.

13.2.19.3 Non-compliance with the Rules in 13.2.19 shall be a Restricted Discretionary activity (see Criteria in 13.4.10).

13.2.20 Design of Loading spaces

13.2.20.1 The layout adopted will depend on the area and shape of the land available, the purpose for which loading is required, and functional design of the **building**. The layout shall be of sufficient size to accommodate the following design vehicles:

- a. for all residential activities, a "99% percentile design car" with a turning radius of 6.3m. Compliance with Standard Drawing R16 in Appendix 13.7.1 shall satisfy this rule.
- b. for all business activities, an "8m Medium Rigid Truck" with a minimum turning radius of 10m. Compliance with Standard Drawing R17 in Appendix 13.7.1 shall satisfy this rule.
- c. for all business activities where articulated vehicles or trucks and trailers are likely to be used, the layout shall be designed to accommodate such vehicles. Compliance with Drawing R18 in Appendix 13.7.1 shall satisfy this rule.

13.2.21 Restricted vehicle access to loading spaces

13.2.21.1 Any vehicle access to **loading spaces** where located within a **restricted vehicle access** as shown on the Planning Maps shall be assessed as a Restricted Discretionary activity.

13.2.22 Traffic Sight Lines at Railway Crossings

13.2.22.1 Approach sight triangles (see Figure 13.1)

On sites adjacent to the level crossings with sightline controls, buildings or structures cannot be located within the approach sight triangles as shown in Figure 13.1.

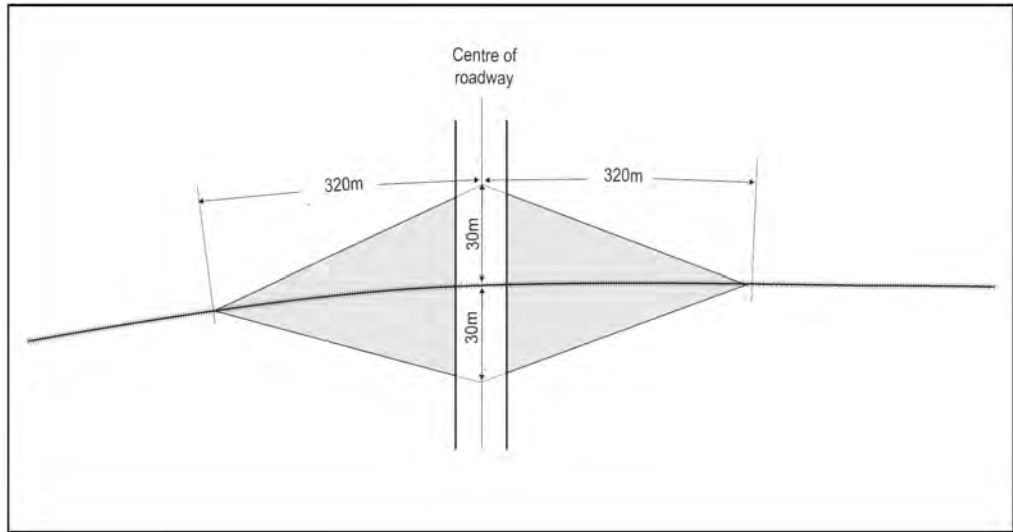

Figure 13.1 Approach site triangles for rail level crossings with “Stop” or “Give Way” signs.

Advice Note: The approach sight triangles ensure that clear visibility is achieved around rail level crossings with “Stop” or “Give Way” signs so that the driver can either:

- See the train and stop before the crossing or
- Continue at the approach speed and cross the level crossing safely.

13.2.22.2

Restart sight triangles (see Figure 13.2)

On sites adjacent to the level crossings with sightline controls, buildings or structures cannot be located within the approach sight triangle as shown in Figure 13.2

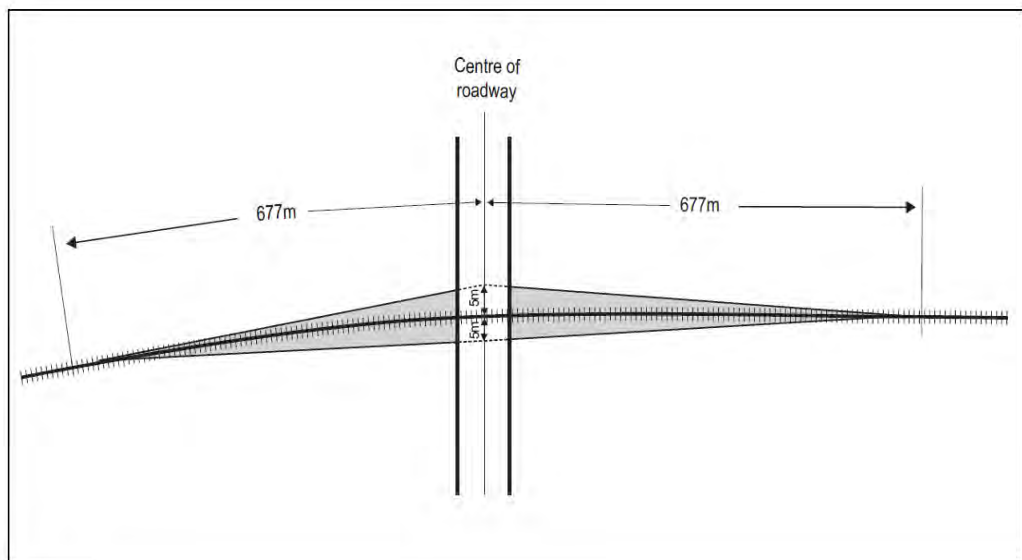

Figure 13.2 Restart site triangles for level crossings

Advice Note: The restart sight triangles ensure that a road vehicle driver stopped at a level crossing can see far enough along the railway to be able to start off, cross and clear the level crossing safely before the arrival of any previously unseen train. Of particular concern are developments that include shelter belts, tree planting, or a series of building extensions. All figures are based on sighting distance formula used in NZTA Traffic Control Device Manual 2008, Part 9 Level Crossings.

13.2.22.3

Non-compliance with the Rules in 13.2.22 shall be a Restricted Discretionary activity.

13.2.23 **Whakatāne and Galatea Airport Approach Path Protection**

13.2.23.1 No **building**, structure, mast, tree or other object or growth shall penetrate the height restrictions/slopes, as described in Appendix 13.7.7.

13.2.24 **Road Widening and Service Lanes**

13.2.24.1 All activities shall be designed so as not to compromise any proposed road widening, service lane or other proposed roading purposes shown on any planning map.

13.2.25 **Bicycle Parking**

13.2.25.1 In all business zones, bicycle parking facilities are required for activities catering for more than 10 people at a rate of 1 bicycle park per 5 people employed.

13.2.26 **Water, Wastewater and Stormwater**

13.2.26.1 Subdivision, use and development that constructs infrastructure to vest in Council shall;

- a. have, where required, appropriate easements in favour of Council for the purpose of operating, maintaining and/or upgrading that asset. Where the diameter of the pipe is 300mm or less, the easement shall be at least 3m wide centred on the pipe. Where the diameter is greater than 300mm, or the depth to the pipe soffit is greater than 2.5m, the easement width is to be greater than 3m. In all cases the actual width will depend on the location of the pipes and shall allow for a 12 tonne excavator and a truck access for **maintenance** and/or replacement of the pipeline. The easement shall ensure that a minimum of 2.5m is provided each side of the water course to allow easy access for **maintenance**;
- b. be compatible with Council's utility system;
- c. be constructed and designed with Council approved materials and componentry; and
- d. be located within the road reserve, otherwise parallel to common property boundaries where practicable.

Advice Note: Compliance with Council's standards as given in its Engineering Code of Practice 2008 shall satisfy these requirements.

13.2.27 **Wastewater**

13.2.27.1 All new **lots** or development within any of the Council's wastewater scheme boundary shall be provided with an individual connection to the Council's scheme.

13.2.27.2 For any **lot** outside, but within 200m of a Council's wastewater scheme boundary, connection to that scheme shall be a Restricted Discretionary activity.

13.2.27.3 Any **lot** that cannot connect practically to Council's wastewater system must have adequate ability to accommodate on site treatment and disposal of wastewater in accordance with Bay of Plenty Regional Council's requirements.

Advice Note: To meet the terms of this performance standard, the Council may require the proof of a consent from the Regional Council.

13.2.27.4 All new wastewater management systems shall be designed and constructed to;

- a. adequately service each **lot**, or development;

- b. be compatible with the existing utility network;
- c. be compatible with other utility systems; and
- d. ensure no ground water or surface water intrusion occurs.

13.2.27.5 Where a proposed development cannot be adequately serviced by a gravity system, pumped systems, will be permitted.

Advice Note: Compliance with Council's standards as given in its Engineering Code of Practice 2008 shall satisfy these requirements.

13.2.27.6 Where a public waste water drain or structure is laid within private property, it shall be protected by an easement in favour of Council.

Advice Note: Compliance with Council's standards as given in its Engineering Code of Practice 2008 shall satisfy these requirements.

13.2.27.7 No building shall be located closer than the greater of;

- a. 1.5m from the centre of any public sewer, or;
- b. the sum of depth of the centreline of the line, plus the diameter of the line, plus 0.2m from the centre of that line.

13.2.27.8 Non-compliance with Rule 13.2.27, will be considered as a Restricted Discretionary activity.

13.2.28 Stormwater

13.2.28.1 No building shall be located closer than the greater of;

- a. 1.5m from the centre of any public stormwater line or;
- b. The sum of depth of the centreline of the line, plus the diameter of the line, plus 0.2m from the centre of that.

13.2.28.2 A stormwater disposal system shall be provided to any residential, community or **business activity** or to any lot to be used for one or more of these activities which includes primary and secondary control systems that;

- a. shall be capable of disposing of surface water resulting from a rainfall event having 10% probability of occurring annually. This system shall contain or dispose of stormwater on site, or direct it into a designated stormwater reticulation and disposal system;
- b. shall provide a secondary flow system capable of conveying surface water resulting from a rainfall event having a 1% probability of occurring annually to ensure that surface water shall not enter buildings (detached garages excluded); and

13.2.28.3 Non compliance with Rule 13.2.28 shall be a Restricted Discretionary activity.

13.2.28.4 All land use and subdivision development in the Whakatāne Urban Area (including the Hub, Coastlands, Piripai and the Gateway industrial area) shall comply with water quantity and quality provisions in the Whakatāne Urban Stormwater Catchment Management Plan and in addition;

- a. all activities shall ensure that stormwater shall be detained to discharge at levels no greater than pre-development levels;

- b. stormwater from properties that are not located in the good ground soakage areas as indicated by the blue shaded areas on the Whakatāne Urban Area – Ground Soakage Plan. Appendix 13.7.4 shall not be discharged into the Council storm water system unless approved by Council.

- 13.2.28.5 Non compliance with Rule 13.2.28.4 shall be considered a Restricted Discretionary activity;
- 13.2.28.6 Open water-courses, where permitted, shall be located in a drainage reserve or easement vested in Council.
- 13.2.28.7 Within the stormwater scheme boundaries of areas shown in Appendix 13.7.3.
- 13.2.28.8 All subdivision and development in the Residential Zone in the Shaw / Huna Road Structure Plan area shall;
- a. comply with Rule 13.2.28.2;
 - b. Implement a partial attenuation stormwater management approach utilising the land area for stormwater attenuation/inundation shown on the Structure Plan in Appendix 2.6.3, together with a discharge to the Kōpeōpeō Canal;
 - c. mitigate the effects of stormwater disposal on the Kōpeōpeō/Ōrini Canals Drainage System including the Kōpeōpeō/Ōrini Flood Pump;
 - d. obtain a comprehensive stormwater discharge consent from the Regional Council;
 - e. construct any required off-site mitigation and/or pump stations and ensure the ongoing operational responsibilities, including maintenance by the relevant local authority, are provided for;
 - f. obtain any necessary floodway and drainage bylaw authority from the Regional Council;
 - g. ensure that overland flow events up to and including a 1% **Annual Exceedance Probability** (AEP) rainfall event does not cause inundation of any adjacent land;
 - h. mitigate for the loss of any existing flood storage area resulting from the development of the land;
 - i. ensure that prior to any subdivision or development, a Development Agreement in accordance with sections 207A-207F of the Local Government Act 2002 is entered into dealing with the mitigation of the effects of stormwater disposal on the Kōpeōpeō-Ōrini Canal Drainage System, including the Kōpeōpeō-Ōrini Flood Pump as required by Rule 13.2.28.8 (c) and (e).

Non-compliance with Rule 13.2.28.8 shall be considered a Restricted Discretionary Activity

Advice Note 1: The Kōpeōpeō Canal is part of the Rangitāiki Plains Drainage Scheme, which is managed by the Bay of Plenty Regional Council. An additional connection to the drainage scheme requires a bylaw approval under the Bay of Plenty Regional Council Floodway and Drainage Bylaw 2008. The discharge of stormwater to the Kōpeōpeō Canal also requires a resource consent from the Regional Council under the Regional Water and Land Plan.

Advice Note 2: A Development Agreement prepared under Rule 13.2.28.8 (i) will need to have regard to the roles and responsibilities of the Bay of Plenty Regional Council in managing the Rangitāiki Plains Drainage Scheme.

13.2.29 Water

- 13.2.29.1 All new lots or development, within any of the Council's water supply scheme boundaries, except those that are in the Rural Plains, Rural Foothills, Rural Coastal, Rural Ōhiwa and CPZs, shall be provided with an individual connection.

- 13.2.29.2 For any lot outside the scheme boundary, but within 200m of a Council's water supply scheme boundary, connection to that scheme shall be a Restricted Discretionary activity.
- 13.2.29.3 For any lot within the Plains water supply scheme, connection to that scheme shall be a Restricted Discretionary activity.
- 13.2.29.4 Domestic connections shall be 20mm in diameter and non-domestic connections shall be of a suitable size to serve the predicted demand of that lot. All connectors other than urban residential connections which are used solely for normal domestic supply shall be provided with an approved back flow prevention device in relation to its backflow hazard classification.
- 13.2.29.5 All connections in universally metered schemes shall be metered. All non-domestic connections in schemes not universally metred shall be metred.
- 13.2.29.6 All water supply systems shall be designed and constructed to;
- a. adequately service each lot, or development;
 - b. be compatible with other utility systems;
 - c. avoid the likelihood of contamination or leakage; and
 - d. ensure principal water mains are not less than 100mm in diameter.
- 13.2.29.7 The pipe network shall generally be designed and constructed to a design life of 80 years.
- 13.2.29.8 Non-compliance with the Rules in 13.2.29 shall be a Restricted Discretionary activity

Advice Note 1: Design Standards for connection are covered by Whakatāne District Council's consolidated bylaws and the Whakatāne District Council's Engineering Code of Practice.

Advice Note 2: The New Zealand Fire Service recommends that water storage volumes and delivery systems be installed in accordance with the New Zealand Fire Service Firefighting Water supplies Code of Practice 2008. The Fire Service advises that often the best method to achieve compliance with this code of practice is through the installation of a home sprinkler system in accordance with Fire Systems for Houses NZS 4517:2010, in each new dwelling. The qualified staff of the New Zealand Fire service would be happy to assist and advise.

Advice Note 3: The taking of surface or groundwater may require consent from the Bay of Plenty Regional Council.

13.2.30 Electricity and Telecommunications Ducting

- 13.2.30.1 Network utilities, including electricity, telecommunication, and where required broadband ducting; shall be provided and shall meet with the approval of the relevant network utility operator.
- 13.2.30.2 For the purpose of a fibre-optic broadband, ducting shall be provided within all greenfield areas as identified (Hillicrest, Shaw/Huna Road, Piripai and Port Ōhope).

13.3 ASSESSMENT CRITERIA FOR CONTROLLED ACTIVITIES

13.3.1 Alternatives to On-Site Vehicle Parking (see Rules in 13.2.17).

- 13.3.1.1 Council shall exercise its control over;

- a. whether the entry and exit points serving the car-park are located to provide safe access without conflict with pedestrians and the movement of vehicles on surrounding streets;
- b. whether it will provide convenient parking for the permitted activity and whether there is appropriate access between the permitted activity and the associated vehicle parking area; and
- c. screening by planting or fencing.

13.4 ASSESSMENT CRITERIA FOR RESTRICTED DISCRETIONARY ACTIVITIES

13.4.1 Lots within 200m of Supply Service Scheme (see Rule 13.2.27.4, 13.2.27.2 and 13.2.29)

13.4.1.1 Council shall restrict its discretion to;

- a. the adequacy of the existing network utilities available without the need for upgrading;
- b. how the proposed development's use of infrastructure resources compares with the maximum residential development intensity provided for in the zone as a Permitted activity; and
- c. the extent to which any adverse or cumulative adverse effects can be remedied or mitigated by on-site measures or by a financial contribution consistent with Chapter 14 (Financial Contributions).

13.4.2 Stormwater Controls (see Rule 13.2.28)

13.4.2.1 Council shall restrict its discretion to;

- a. effects of the activity on neighbouring properties;
- b. how the activity minimises ponding areas; and
- c. how the activity minimises inconveniences to the public; and
- d. the extent to which any adverse or cumulative effects are remedied or mitigated.

13.4.3 Buildings or Structures Built Over Existing Infrastructure (see Rule 13.2.27.7 and 13.2.28.1)

13.4.3.1 Council shall restrict its discretion to;

- a. the type of buried pipe i.e. no building or structure shall be allowed to be built over a public rising main and trunk mains; nor be allowed to be built closer than the greater of;
 - i. 1.5m from the centre of the pipe;
 - ii. the depth of the centreline of the pipe, plus the diameter of the pipe, plus 0.2m from the centre of the pipe, subject to the building developer meeting the costs of any specific requirements.

13.4.4 Discharge to an Existing Stormwater Network (see Rule 13.2.28.4)

13.4.4.1 Council shall restrict its discretion to;

- a. the ability for on-site soakage and/or management of stormwater. This may be determined through soil soakage rates and other on-site constraints (e.g. existing land use and slope and stability)

limitations); and

- b. the capacity of the reticulation potential downstream effects.

13.4.5 **Secondary Flow Systems (see Rule 13.2.28.2 (b))**

13.4.5.1 Council shall restrict its discretion to;

- a. the probability of providing this level of protection; and
- b. the likely effect on public and private property.

13.4.6 **Wastewater (see Rules in 13.2.27), Stormwater Disposal (see Rules in 13.2.28), Water Supply (see Rules in 13.2.29)**

13.4.6.1 Council shall restrict its discretion to;

- a. consistency with the policies and objectives of the District Plan relating to infrastructural assets;
- b. the location and design of the infrastructure assets and ease of maintenance;
- c. health and safety;
- d. the degree to which any alternative design will impact the character and amenity values of the surrounding properties;
- e. the degree to which any alternative design will impact on the performance of existing utility systems; and
- f. the requirement for development to ensure that infrastructure to be vested meets the minimum construction and technical specification requirements of the Council; and
- g. the ability to accommodate on-site treatment and disposal of wastewater in accordance with Regional Council requirements.

13.4.7 **Roads and Property Access excluding State Highway (see Rules in 13.2.2), Sight Lines (see Rule 13.2.2.2 (i), Provision of Loading spaces (see Rules in 13.2.18), Restricted vehicle access Parking (see Rules in 13.2.15), Design Construction Private ways, Access Legs, Access Lots or Common Areas Utilised for Vehicle Access on a Cross or Company Lease or Unit Title (see Rules in 13.2.4), Design Construction of Vehicle Crossing Excluding State Highway (see Rules in 13.2.5) and Restricted Vehicle access to Loading spaces (13.2.21)**

13.4.7.1 Council shall restrict its discretion to;

- a. traffic volumes and traffic mix relative to existing and future patterns, access, parking and loading on-site;
- b. pedestrian and cyclist safety;
- c. construction traffic volumes, traffic mix and hours of operation;
- d. the ability of the site to accommodate the traffic anticipated and the nature of the adjacent roading pattern, including the position of the road in the roading hierarchy;

- e. formation of the road or access;
- f. the total land area proposed to be used for access, parking and loading in the Rural Plains Zone; and
- g. aspects of the proposal that could compromise the safety and convenience of pedestrians as well as individual and cumulative adverse effects associated with traffic movements.

13.4.8 *Deleted as per updates on 17 December 2021 - Removal of minimum parking requirements as per National Policy Statement on Urban Development 2020 (section 3.38).*

13.4.9 Pedestrian Streets—Business Centre and Commercial Zones (see Rules 13.2.8)

13.4.9.1 Council shall restrict its discretion to;

- a. amenity values – whether the location of the new crossing will lessen the importance of the Pedestrian Street as a connecting pedestrian linkage between retail activities. New crossings in streets having higher pedestrian movements will be discouraged.
- b. pedestrian safety – whether the new crossing will create a conflict between pedestrians and vehicles having regard to visibility factors and the likely intensity of vehicle use.

13.4.10 Construction of Parking Spaces, Access, Manoeuvring and Loading Areas (see Rules in 13.2.14 and 13.2.19)

13.4.10.1 Council shall restrict its discretion to;

- a. site layout – whether the location of unsealed outdoor areas used for parking, access, loading or the storage of materials will discharge dust beyond the boundaries of the property that will have an adverse effect on the level of amenity values on nearby sites. The Council will consider whether other locations on the site or other methods can be implemented to avoid, remedy or mitigate any adverse effects on nearby uses, or to maintain the amenity values of the surrounding area.
- b. compatibility with nearby activities – whether the on-site activities will be compatible with other activities provided for in the zone and on adjoining sites, and not be hazardous to the health and safety of the occupiers and users of surrounding land.
- c. whether the activity will have an adverse effect on air quality in the area with regard to the prevailing air quality and the sensitivity of activities in the area. In particular, the measures to be taken to avoid or remedy any such potential adverse effects including cumulative effects.

Advice Note: The Regional Air Plan, administered by the Bay of Plenty Regional Council, is the principal document dealing with discharges of contaminants into air.

13.4.11 Subdivision and New Vehicle Access Directly to the State Highway and Limited access roads (see Rule 13.2.6 and 13.2.7.3)

13.4.11.1 Council shall restrict its discretion to;

- a. the adverse effects of the proposal on the safe and efficient operation, and function of the State Highway;
- b. any measures required to avoid, remedy or mitigate adverse effects on the safe and efficient functioning of the State Highway network.

13.4.12 Railway Level Crossing Sightline Requirements (see Rules in 13.2.22)

13.4.12.1 Council shall restrict its discretion to;

- a. the nature of the development and its ability to meet the unobstructed sight lines required for rail operations.
- b. whether or not the proposal will have an adverse effect on the safety of the level crossings for vehicles and pedestrians.
- c. whether or not the proposal will adversely affect visibility and safe sight distances particularly to the extent vehicles entering/exiting the level crossing can see trains.

13.4.13 Wastewater (see Rules in 13.2.27)

13.4.13.1 Council shall restrict its discretion to;

- a. consistency with the policies and objectives of the District Plan relating to infrastructural assets;
- b. the location and design of the infrastructure assets and ease of maintenance;
- c. health and safety; and
- d. the degree to which any alternative design will impact the character and amenity values of the surrounding properties.

13.5 ASSESSMENT CRITERIA—DISCRETIONARY ACTIVITIES / NON-COMPLYING ACTIVITIES

See Section 3.7.

13.6 OTHER METHODS

13.6.1.1 The Council will:

- a. encourage schools to prepare transportation plans in collaboration with Council and other agencies to provide alternative forms of transportation to and from school, and to include this into an application for outline plan approval or notice of requirement for a new designation.

13.7 APPENDICES

13.7.1 Engineering Drawings

Vehicle Crossing Residential

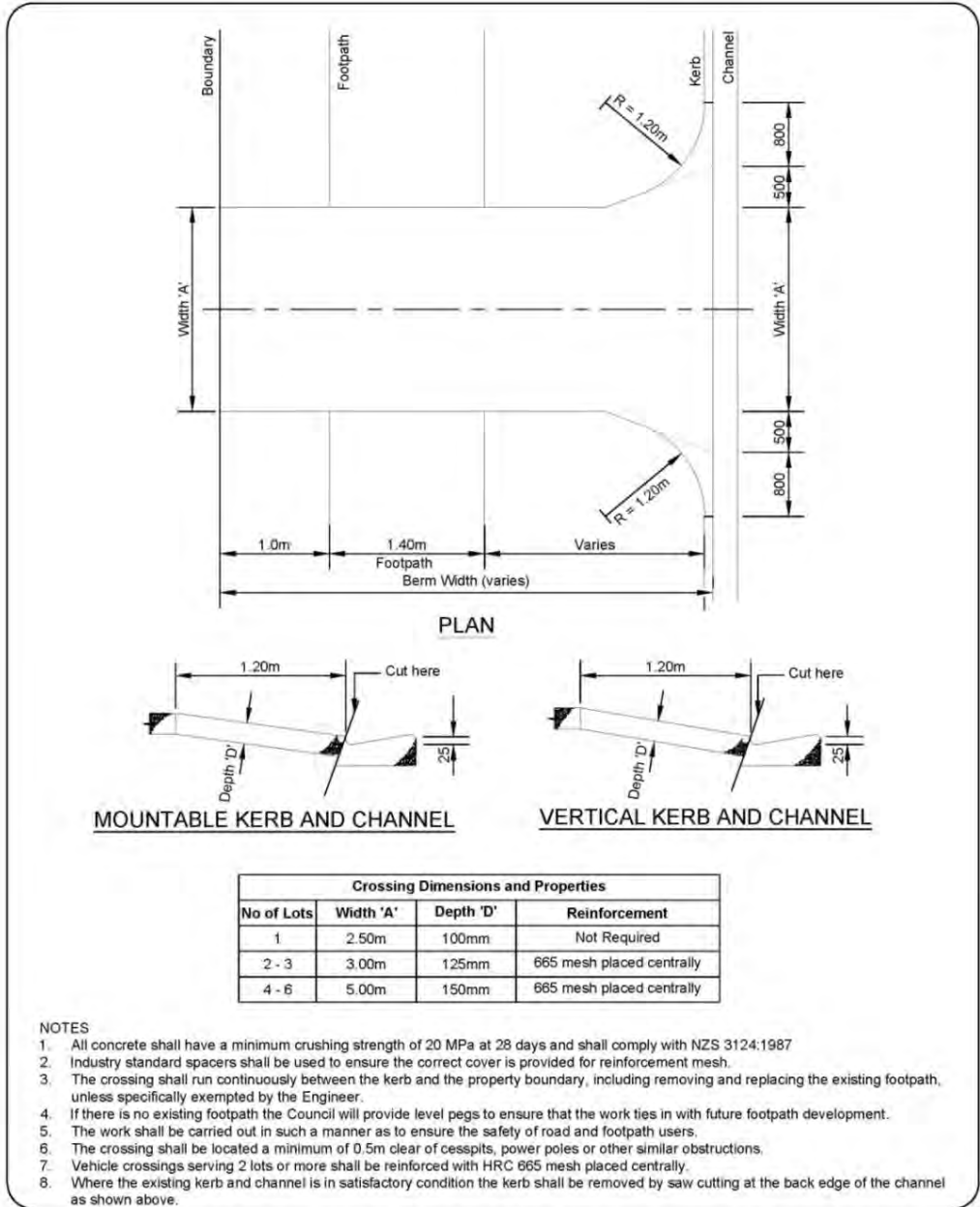

WHAKATANE DISTRICT COUNCIL

STANDARD DRAWING

NOT TO SCALE

WHAKATANE District Council
He Whakatane ki te Kaitiaki

PREPARED BY OPUS

**VEHICLE CROSSING
RESIDENTIAL**

R 08

ISSUE 8.0
APRIL 2011

Vehicle Crossing Industrial/Commercial

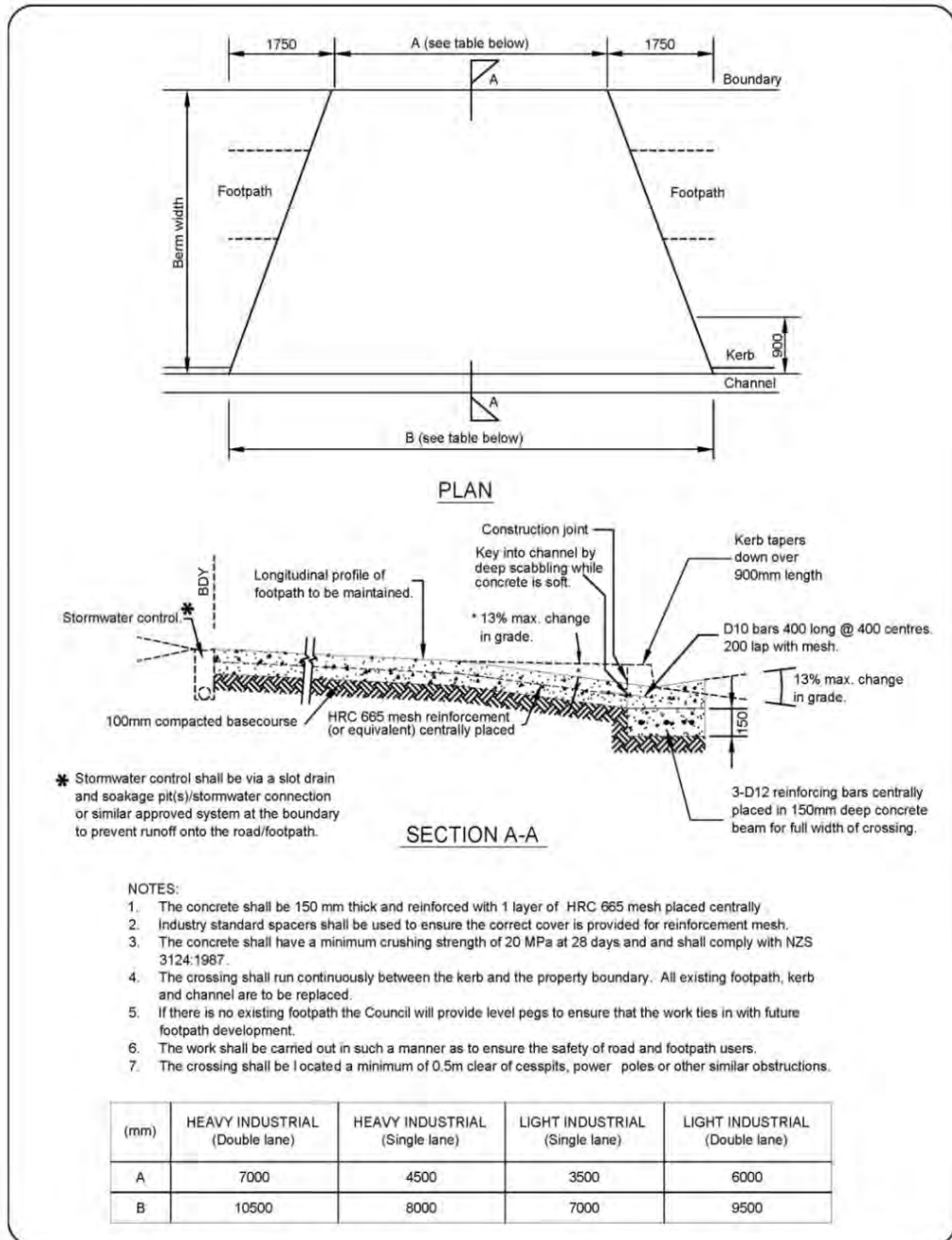



WHAKATANE
DISTRICT
COUNCIL

WHAKATANE
District Council
Kōwhiriwhiriwhiri o Te Kaitiaki

PREPARED BY 

STANDARD DRAWING

NOT TO SCALE

**VEHICLE CROSSING
INDUSTRIAL / COMMERCIAL**

R 09

ISSUE 8.0
APRIL 2011

Urban Accessway Construction Details

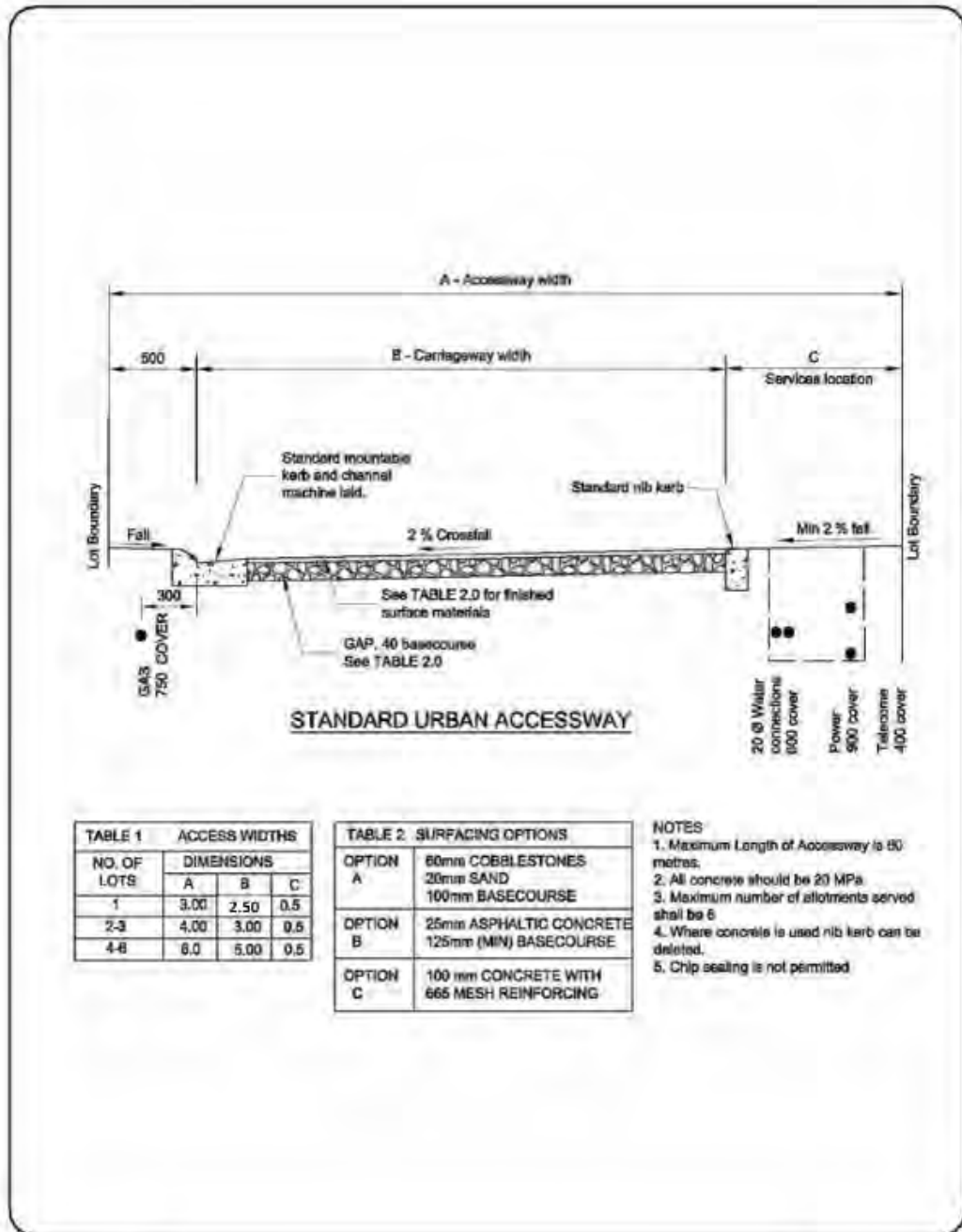

STANDARD URBAN ACCESSWAY

NO. OF LOTS	DIMENSIONS		
	A	B	C
1	3.00	2.50	0.5
2-3	4.00	3.00	0.5
4-6	6.0	5.00	0.5

OPTION A	60mm COBBLESTONES 20mm SAND 100mm BASECOURSE
OPTION B	25mm ASPHALTIC CONCRETE 125mm (MIN) BASECOURSE
OPTION C	100 mm CONCRETE WITH 666 MESH REINFORCING

- NOTES**
1. Maximum Length of Accessway is 80 metres.
 2. All concrete should be 20 MPa.
 3. Maximum number of allotments served shall be 6.
 4. Where concrete is used nib kerb can be deleted.
 5. Chip sealing is not permitted.



STANDARD DRAWING

NOT TO SCALE

**STANDARD URBAN ACCESSWAY
CONSTRUCTION DETAILS**

R 13
ISSUE 7.0
SEPTEMBER 2007

Design Tracking Curves for 99% Percentile Car

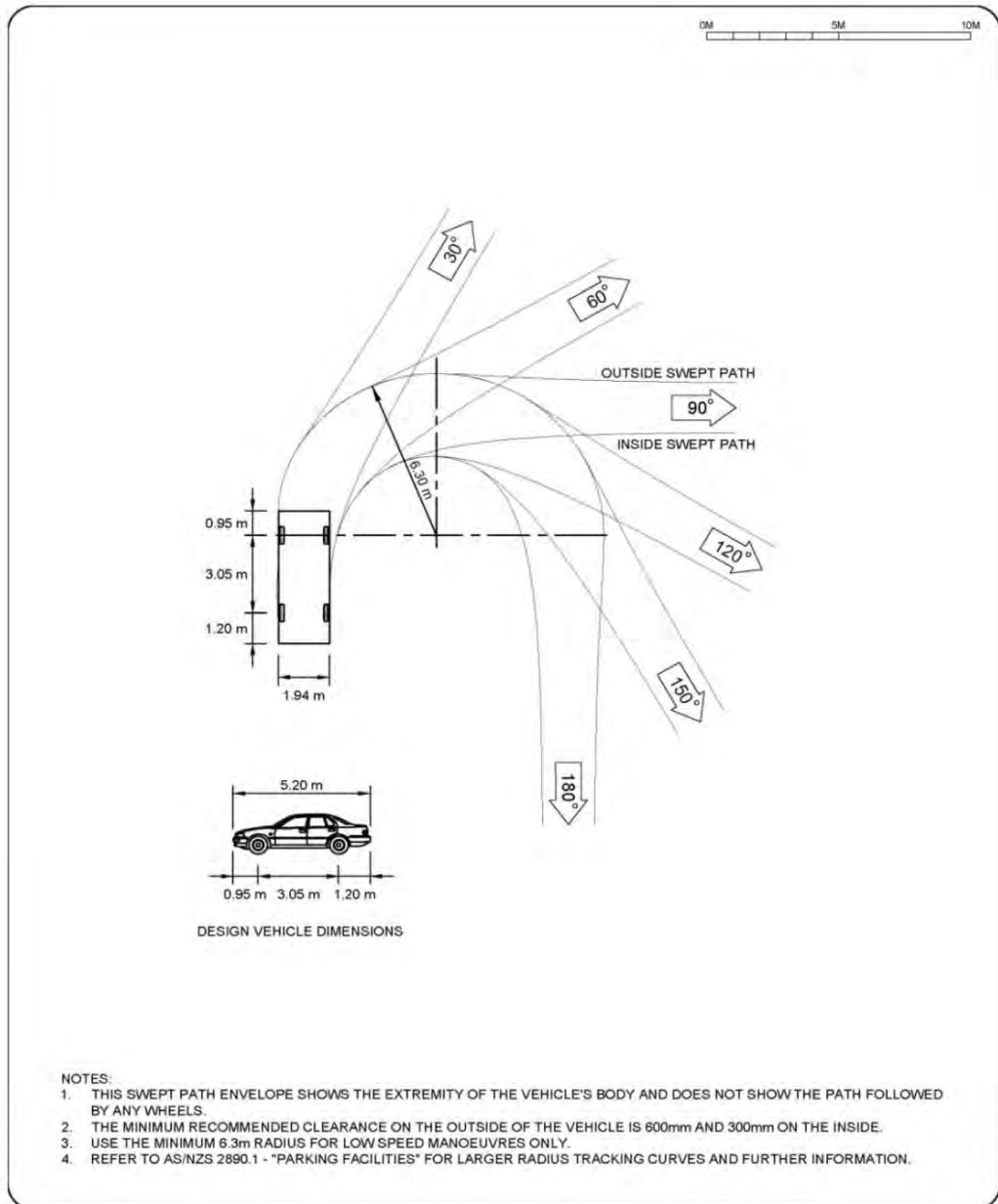

WHAKATANE
DISTRICT
COUNCIL



PREPARED BY **OPUS**

STANDARD DRAWING

SCALE: 1:200

DESIGN TRACKING CURVES
99 PERCENTILE DESIGN CAR

R 16

ISSUE 8.0
APRIL 2011

Design Tracking Curve 8m Medium Rigid Truck

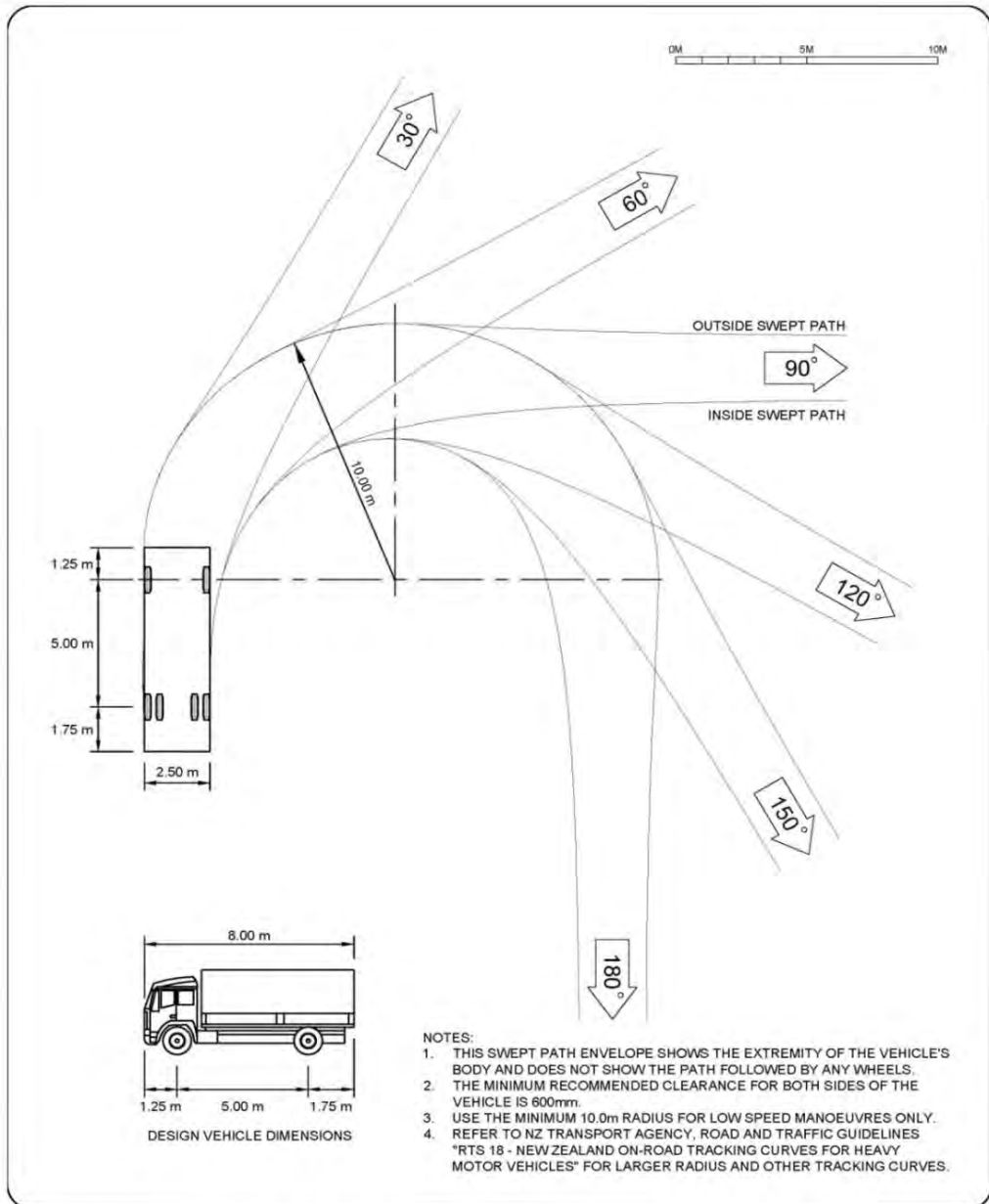

STANDARD DRAWING

SCALE: 1:200

DESIGN TRACKING CURVES
8m MEDIUM RIGID TRUCK

R 17
ISSUE 8.0
APRIL 2011

Design Tracking Circle 18m Semi-Trailer

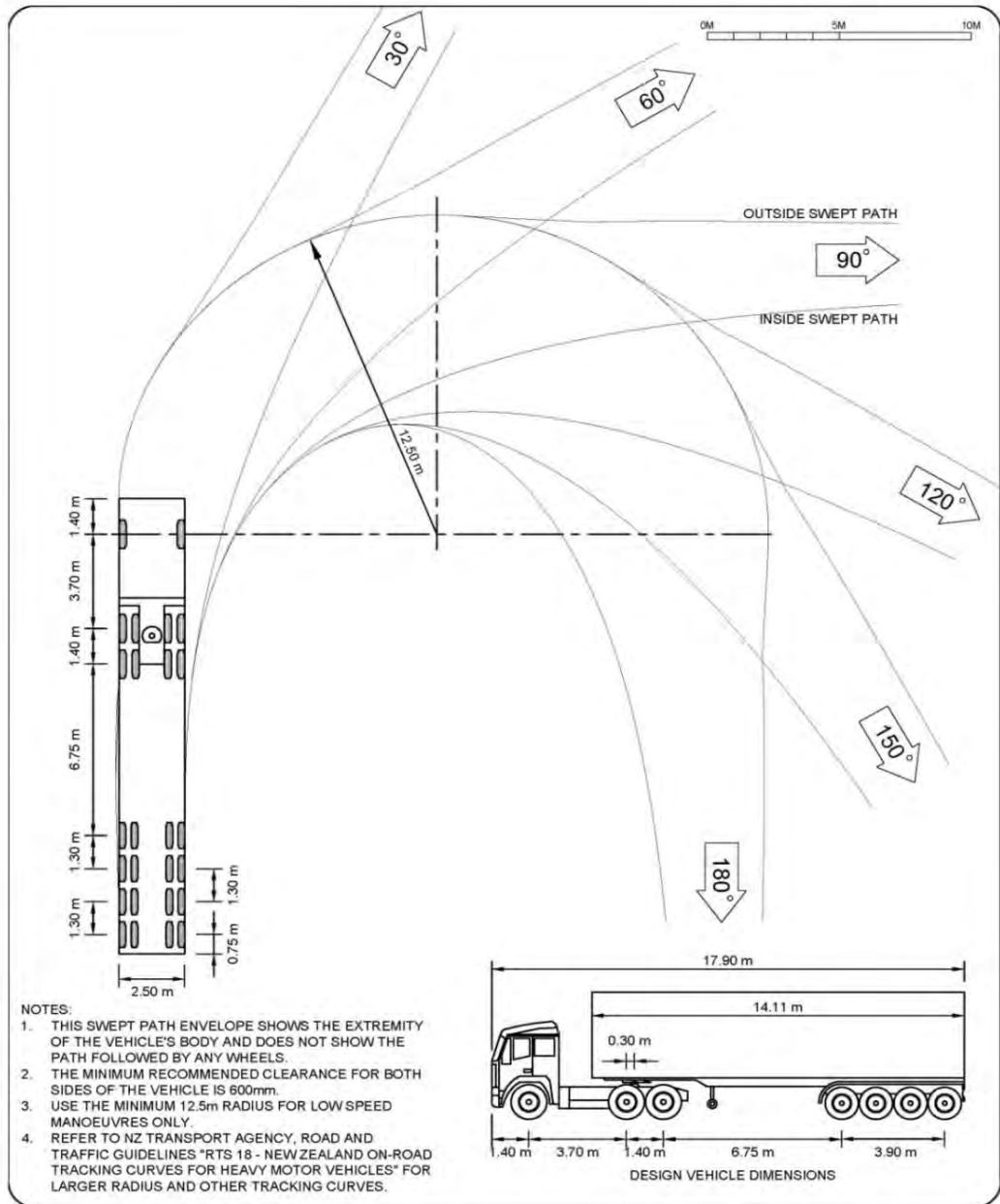

WHAKATANE
DISTRICT
COUNCIL



PREPARED BY OPUS

STANDARD DRAWING

SCALE: 1:200

DESIGN TRACKING CURVES
18m SEMI-TRAILER

R 18

ISSUE 8.0
APRIL 2011

Sight Distances for Vehicle Entrances

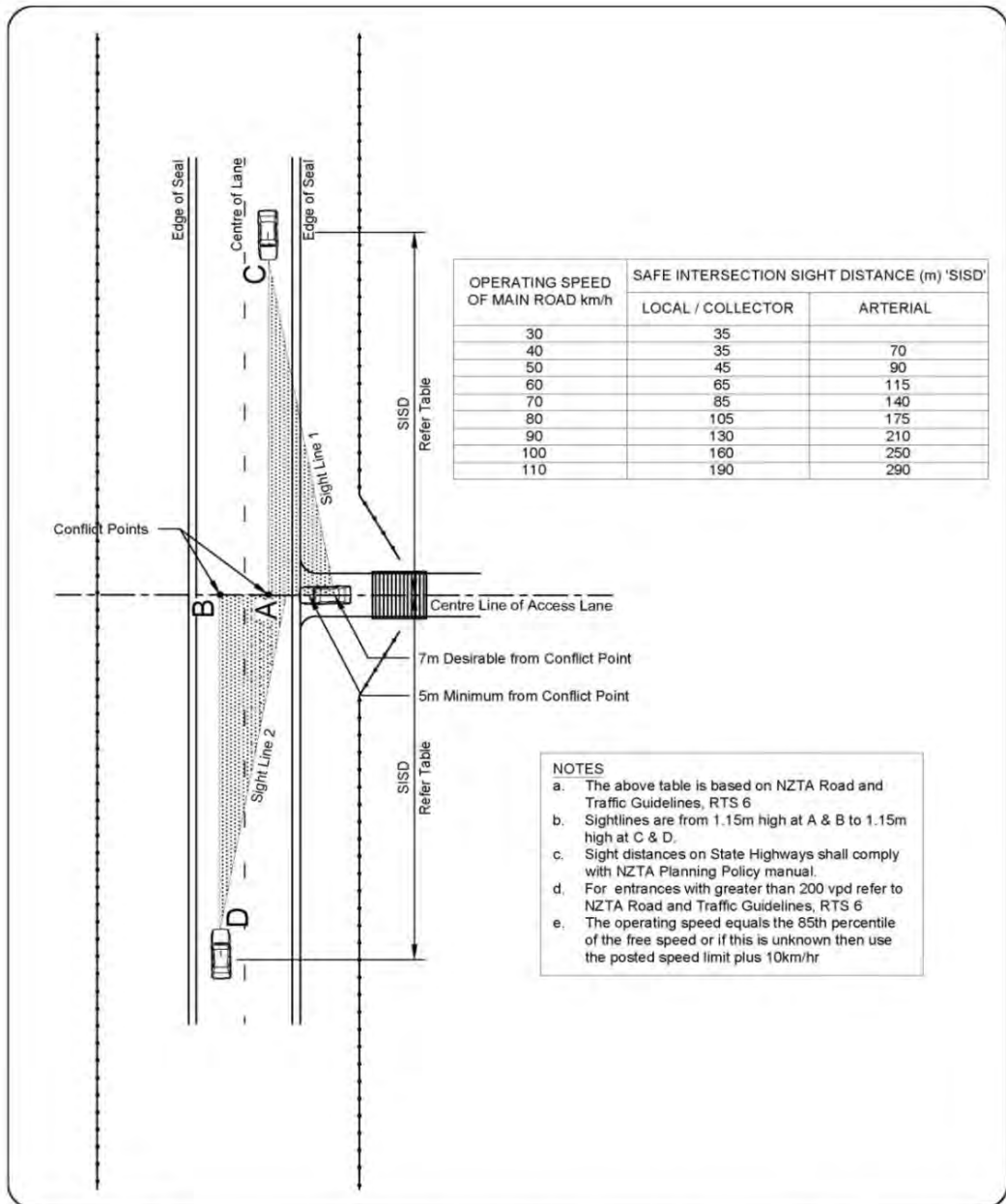

WHAKATANE DISTRICT COUNCIL



PREPARED BY OPUS

STANDARD DRAWING

NOT TO SCALE

SIGHT DISTANCES FOR VEHICLE ENTRANCES

R 25
ISSUE 8.0
APRIL 2011

Rural Vehicle Entrance 1 to 4 Lots

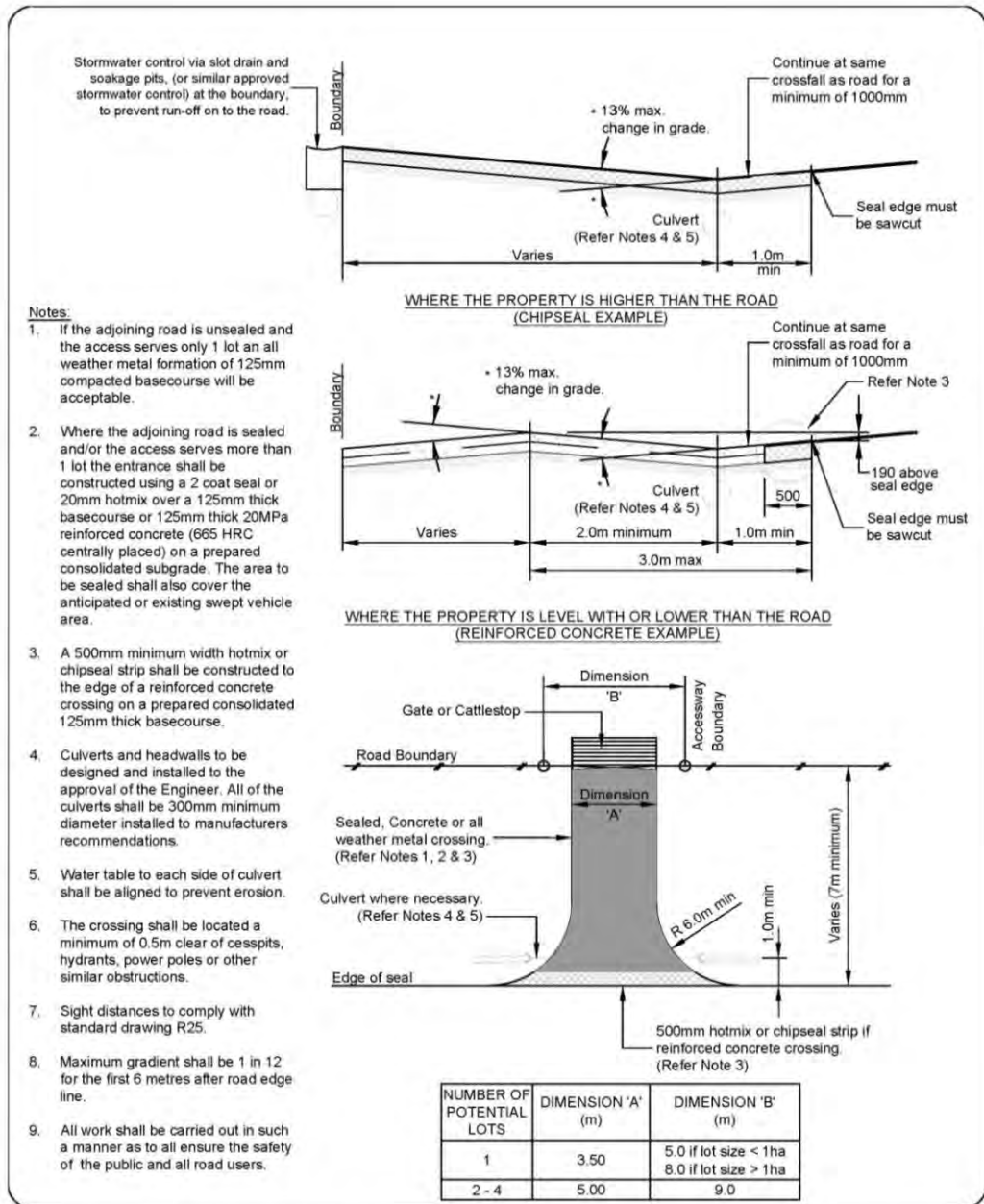

WHAKATANE DISTRICT COUNCIL



PREPARED BY OPUS

STANDARD DRAWING

NOT TO SCALE

RURAL VEHICLE ENTRANCE
1 TO 4 LOTS
(LIGHT VEHICLES ONLY)

R 28

ISSUE 8.0
APRIL 2011

Rural Vehicle Entrance 5 or More Lots

LENGTH OF SHOULDER WIDENING	
Posted Speed Limit	D (m)
100	90
80	70
70	60

NOTES:

1. The vehicle entrance and widening shall consist of a 2 coat seal over 150mm minimum thickness basecourse on a prepared and consolidated subgrade. Required basecourse thickness to be determined using the Austroads Pavement Design Guide.
2. All areas shown hatched shall be sealed except that the sealing of the area on the side of the road opposite the entranceway shall be required only when vehicles movements along the road exceed 500 vehicles per day.
3. All markings shall comply with the TNZ Manual of Traffic Signs and Markings.
4. The sealed area is to be shaped such that storm water or loose metal does not migrate on to the carriageway.
5. If existing lanes are less than 3.5m wide then widening will be more than 2.5m to achieve a 6m width.
6. Culverts and headwalls to be designed and installed to the approval of the Engineer. All culverts shall be 300mm minimum diameter installed to the manufacturers recommendations.
7. Water table to each side of culvert shall be aligned to prevent erosion.
8. Sight distances to comply with Standard Drawing R 25.
9. Maximum gradient shall be 1 in 12 for first 6 metres after road edge line.
10. All work shall be carried out in such a manner as to ensure the safety of the public and all road users.

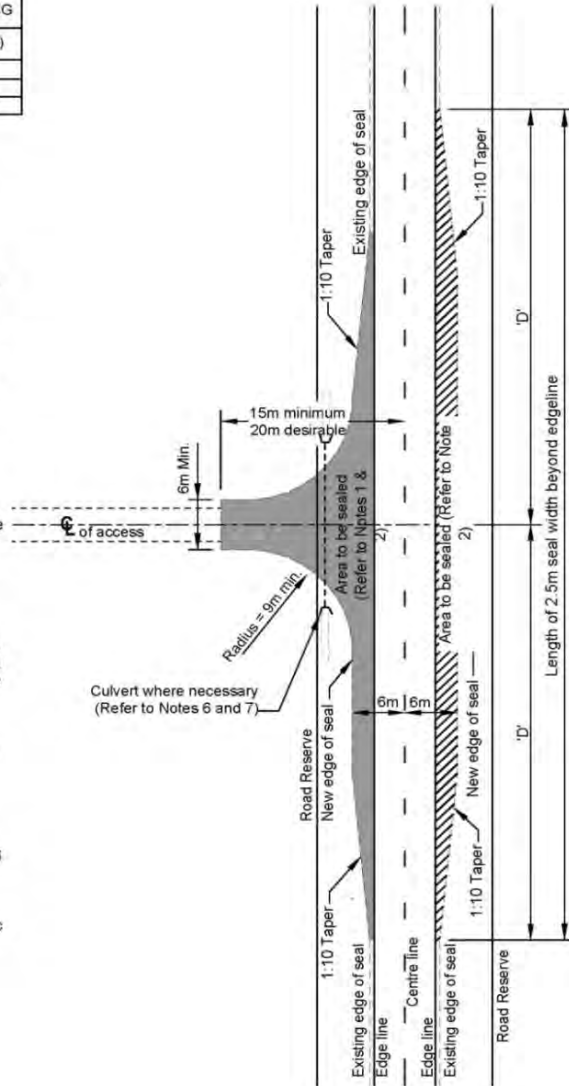

STANDARD DRAWING

NOT TO SCALE

RURAL VEHICLE ENTRANCE
 5 OR MORE LOTS

R 29
 ISSUE 8.0
 APRIL 2011

Rural Vehicle Entrances Heavy Commercial/Tanker

NOTES:

- The vehicle entrance and widening shall consist of a 2 coat seal over 150mm minimum thickness basecourse on a prepared and consolidated subgrade. Required basecourse thickness to be determined using the Austroads Pavement Design Guide.
- All areas shown hatched shall be sealed except that the sealing of the area on the side of the road opposite the entranceway shall be required only when vehicles movements along the road exceed 500 vehicles per day.
- The crossing is required to be sealed for a minimum of 10 metres from the existing road edge.
- The sealed area is to be shaped such that storm water or loose metal does not migrate on to the carriageway.
- All markings to comply with the TNZ Manual of Traffic Signs and Markings.
- If existing lanes are less than 3.5m wide then widening will be more than 2.5m to achieve 6m width.
- Water table to each side of culvert shall be aligned to prevent erosion.
- Culverts and headwalls to be designed and installed to the approval of the Engineer. All culverts shall be 300mm minimum diameter installed to the manufacturers recommendations.
- Sight distances to comply with Standard Drawing R25.
- Maximum gradient shall be 1 in 12 for first 6 metres after road edge line.
- All work shall be carried out in such a manner as to ensure the safety of the public and all road users.
- Gate or cattle stop shall be set back to allow vehicles to be parked off carriageway while opening and closing gates (20m min for milk tanker).

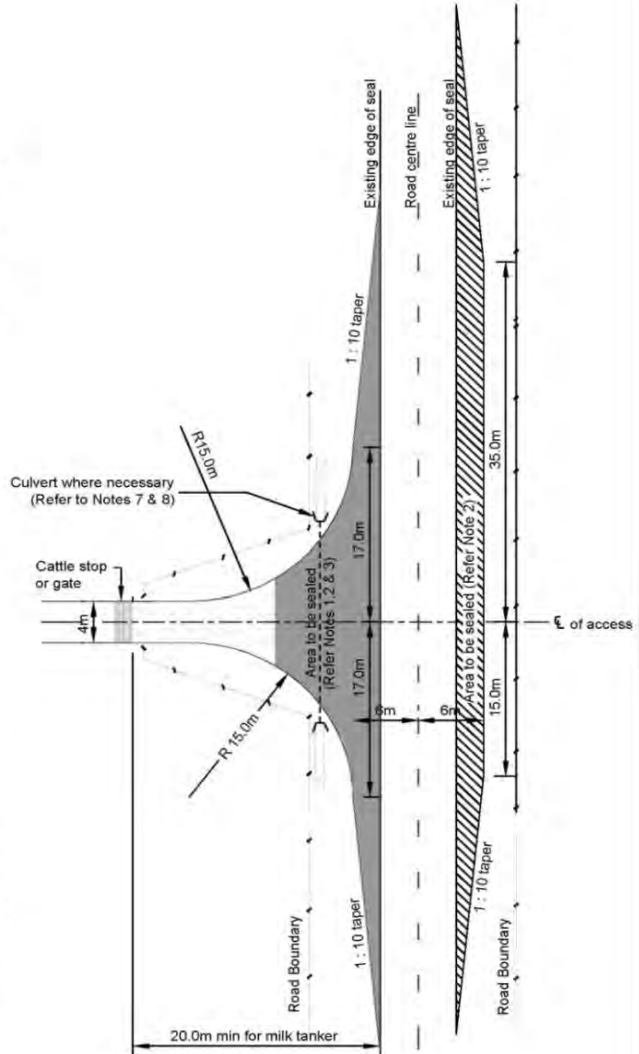

WHAKATANE
DISTRICT
COUNCIL



PREPARED BY **OPUS**

STANDARD DRAWING

NOT TO SCALE

RURAL HEAVY COMMERCIAL
TANKER ENTRANCES

R 30

ISSUE 8.0
APRIL 2011

Private Drain Connection to an Existing Lateral

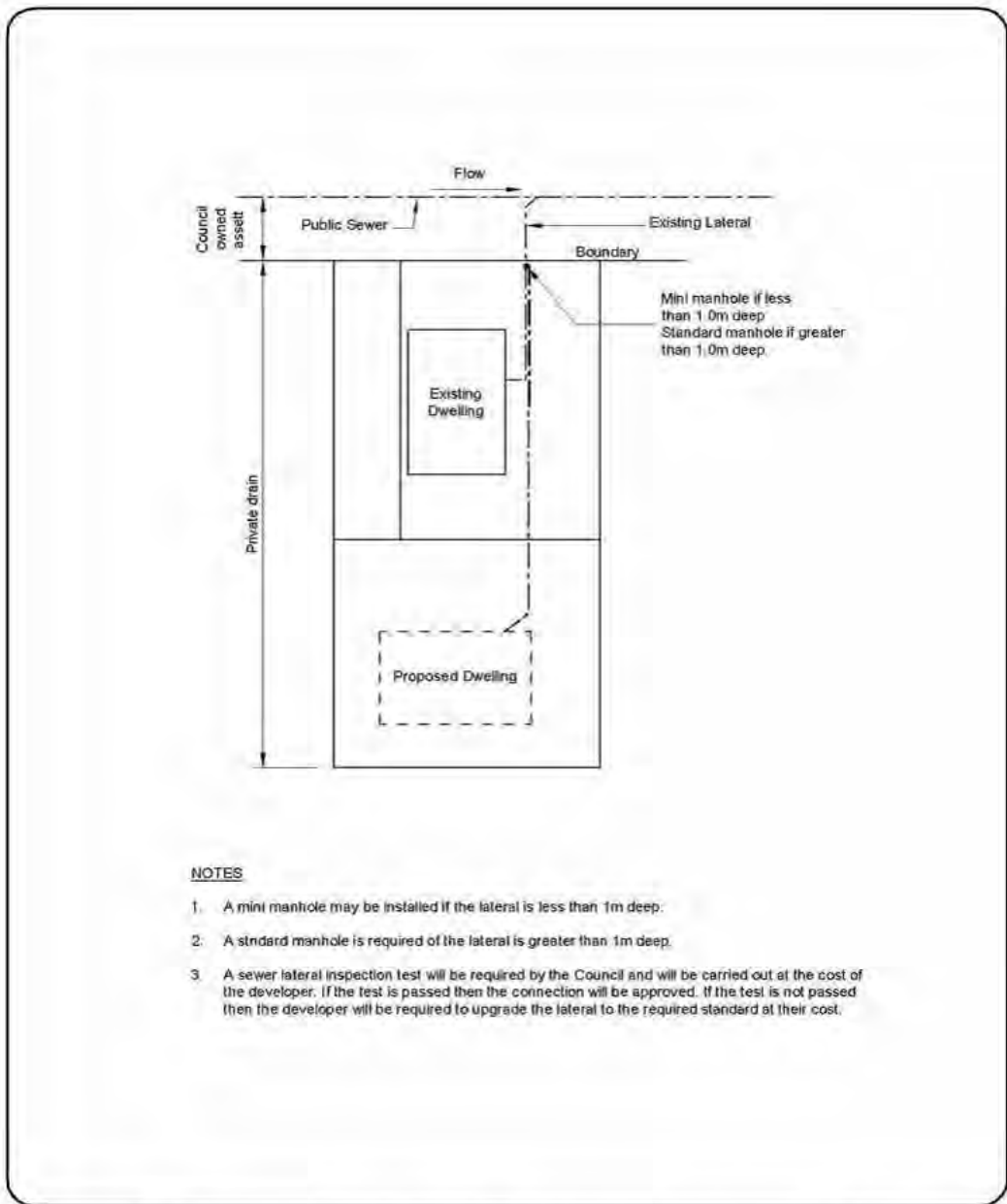

STANDARD DRAWING

NOT TO SCALE

PRIVATE DRAIN to an
EXISTING LATERAL CONNECTION

SS 10
ISSUE 7.0
SEPTEMBER 2007

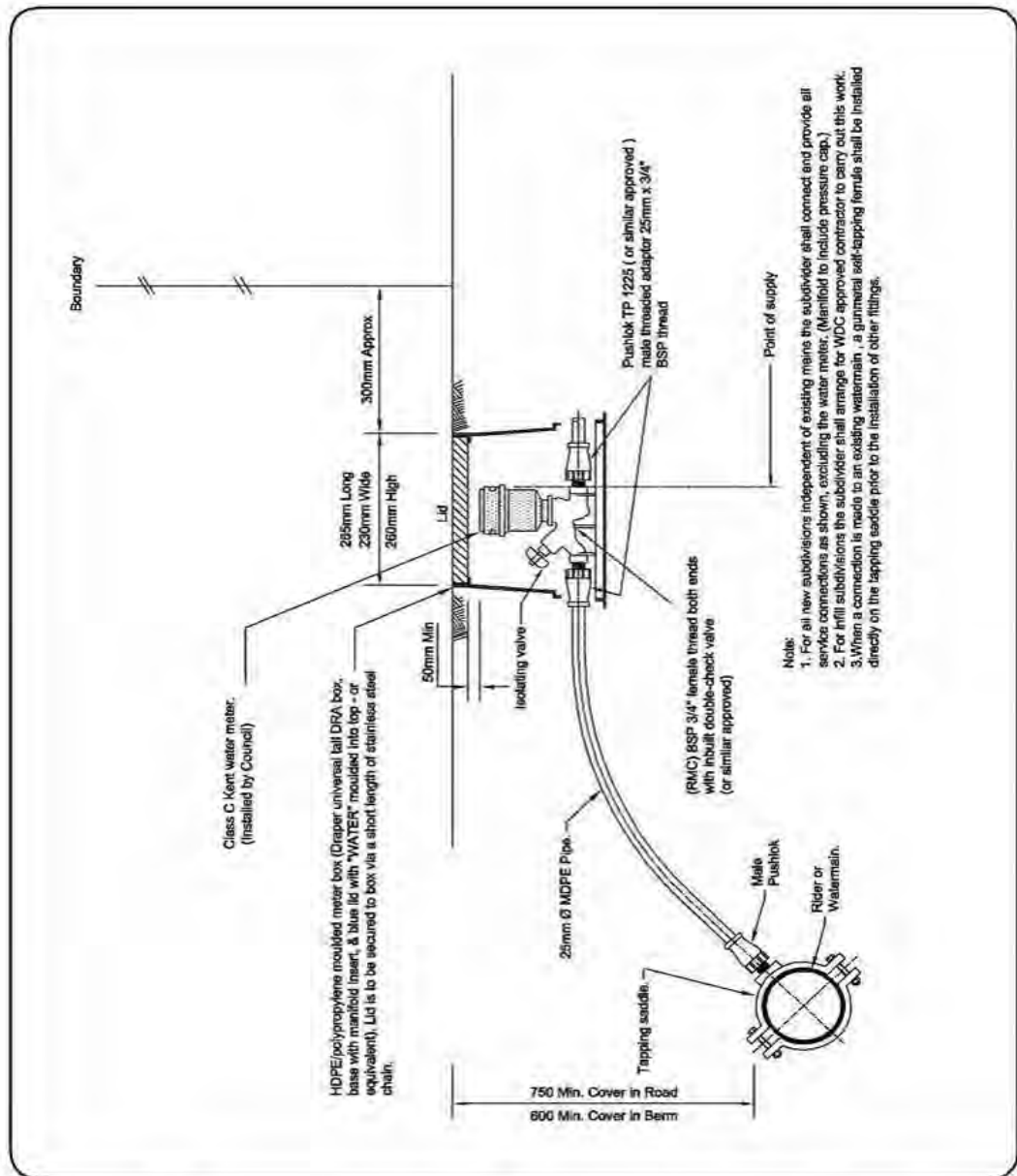

STANDARD DRAWING

NOT TO SCALE

SERVICE CONNECTION
DOMESTIC

WS 05
ISSUE 7.0
SEPTEMBER 2007

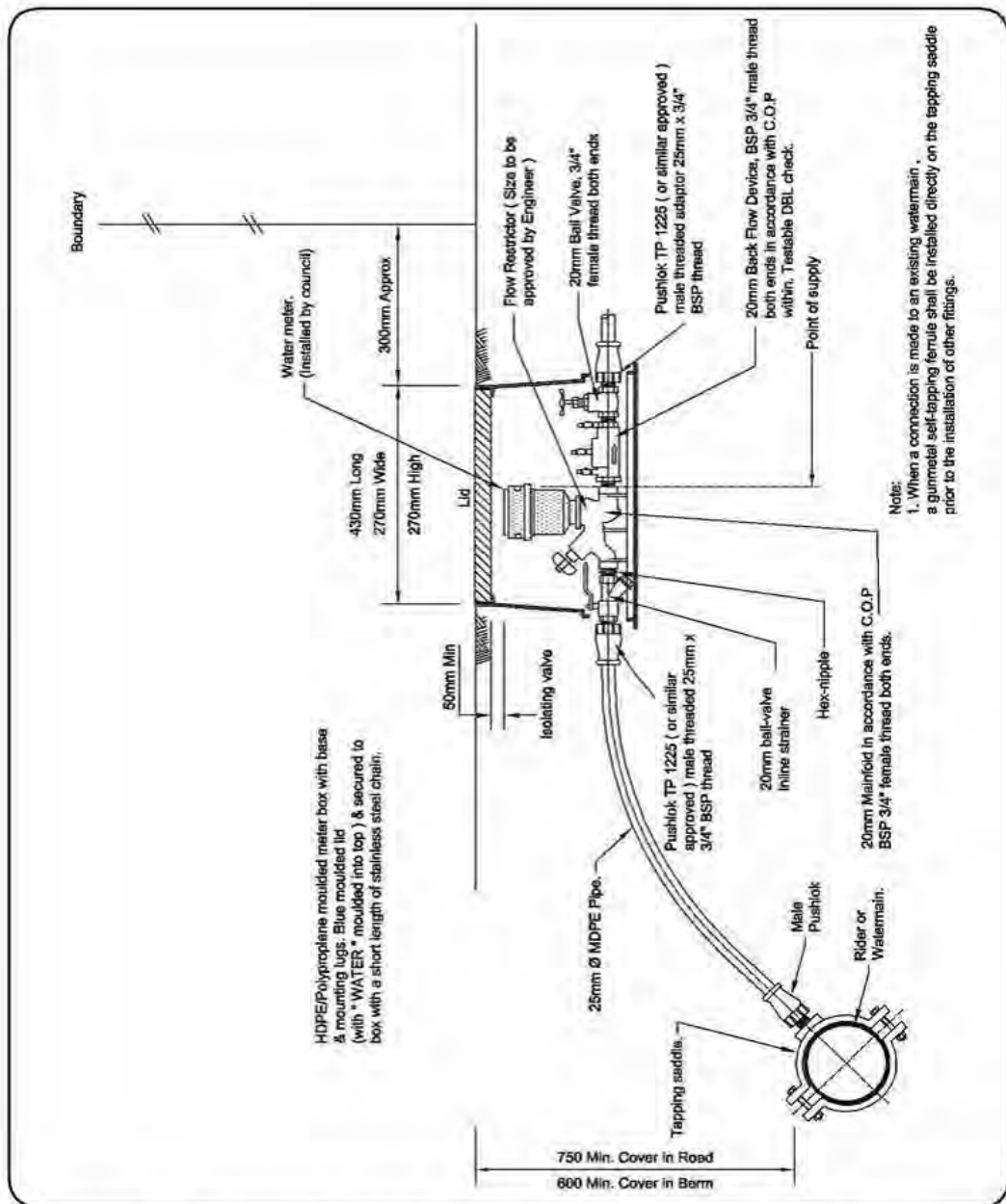

STANDARD DRAWING

NOT TO SCALE

SEVICE CONNECTION RURAL/INDUSTRIAL

WS 06

ISSUE 7.0
SEPTEMBER 2007

13.7.2 Parking Stall Dimensions

NOTES:

1. These standards are based on AS 2890.1 : 1993 table 1 and Fig. 2.2 for Class 2 facility (Long Term Casual Parking). Full range of dimensions for Class 1-4 given in AS 2890.1 : 1993.

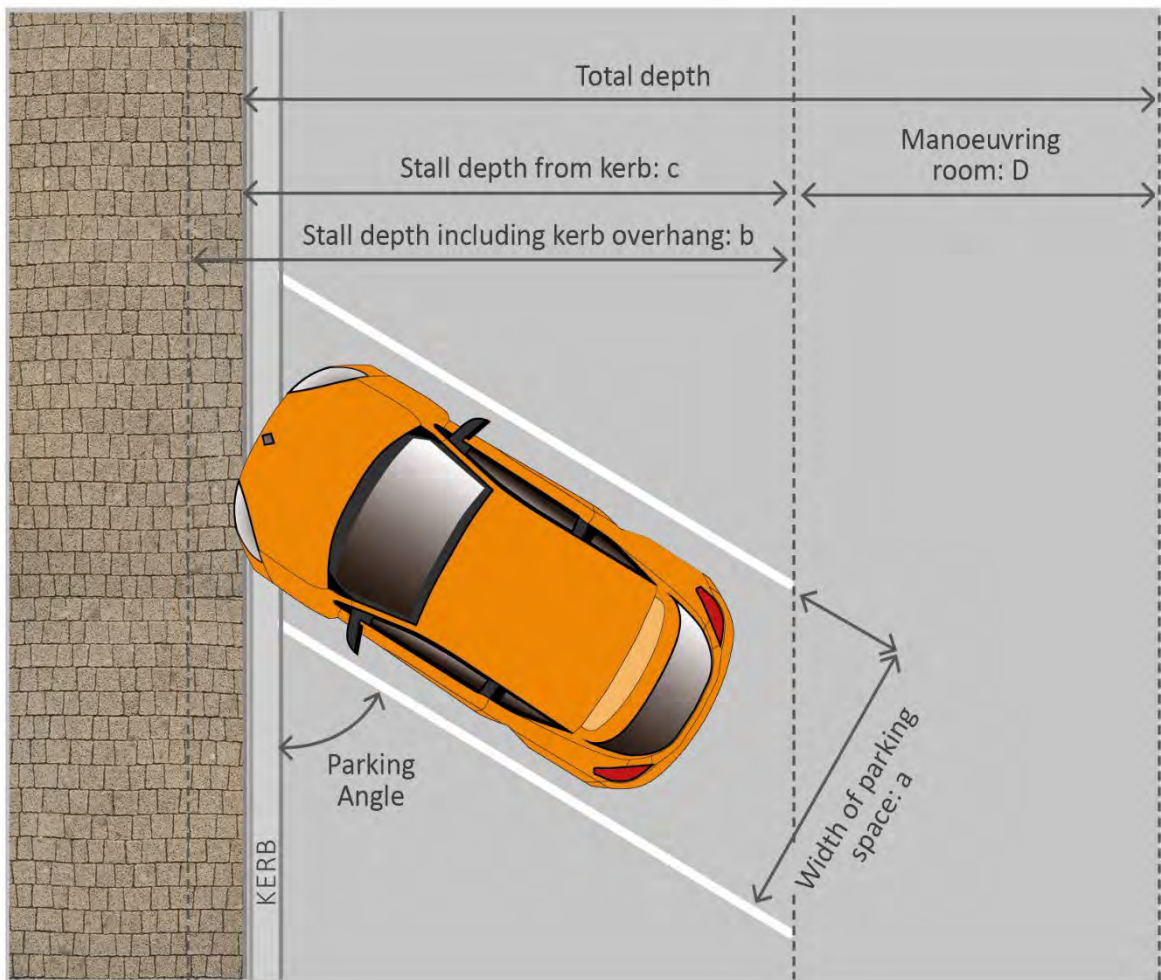

Type of Parking	Stall Width: a	Stall Depth for Wall: b	Stall Depth for Kerb: c	Length	Aisle Width: d	Total Depth One Row	Total Depth Two Rows
Parallel	2.5m	-	-	6.0m	-	-	-
45°	2.5m	5.2m	4.8m	-	3.7m	8.9m	14.1m
60°	2.5m	5.4m	5.1m	-	4.6m	10.6m	16.0m
90°	2.5m	5.2m	4.8m	-	5.8m	10.6m	16.0m

13.7.3 Urban and Plains Utility Boundaries (Rules 13.2.27, 13.2.28 and 13.2.29)

Ōhope



Figure 13.3 Ōhope Stormwater Scheme Boundary



Figure 13.4 Ōhope Wastewater Scheme Boundary



Figure 13.5 Ōhope Water Scheme Boundary

Whakatāne



Figure 13.6 Whakatāne Stormwater Scheme Boundary

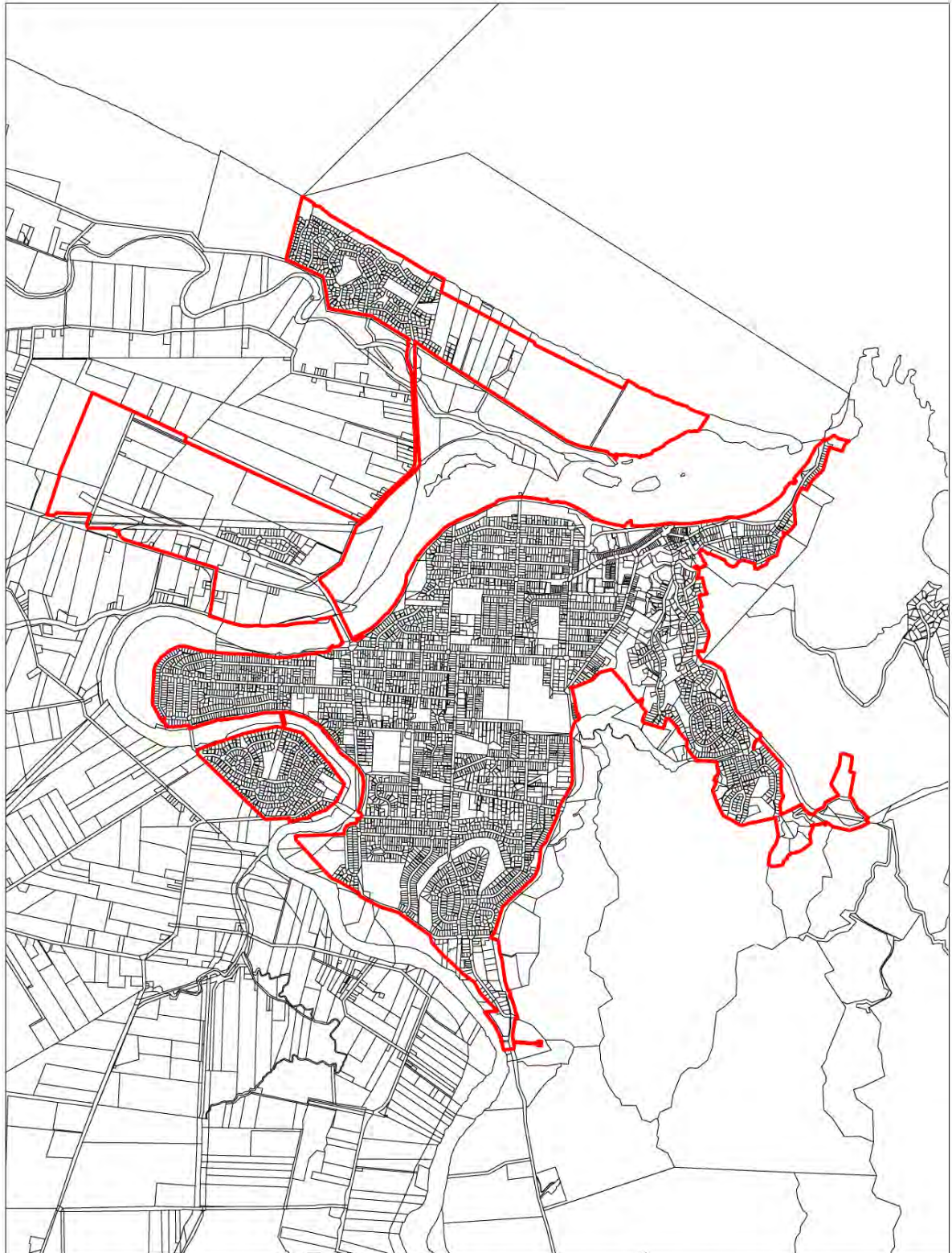

Figure 13.7 Whakatāne Wastewater Scheme Boundary

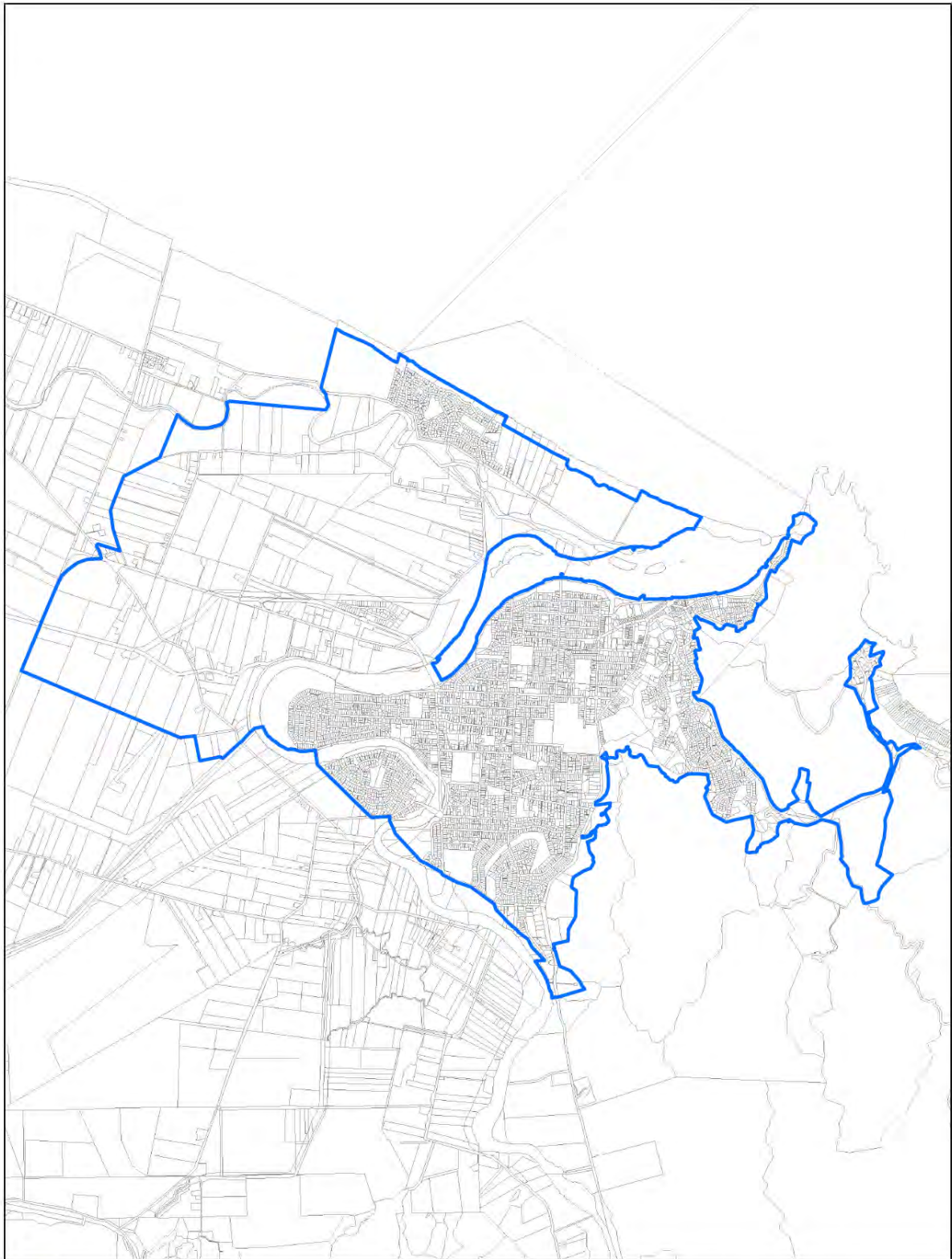

Figure 13.8 Whakatāne Water Scheme Boundary

Edgecumbe



Figure 13.9 Edgecumbe Stormwater Scheme Boundary

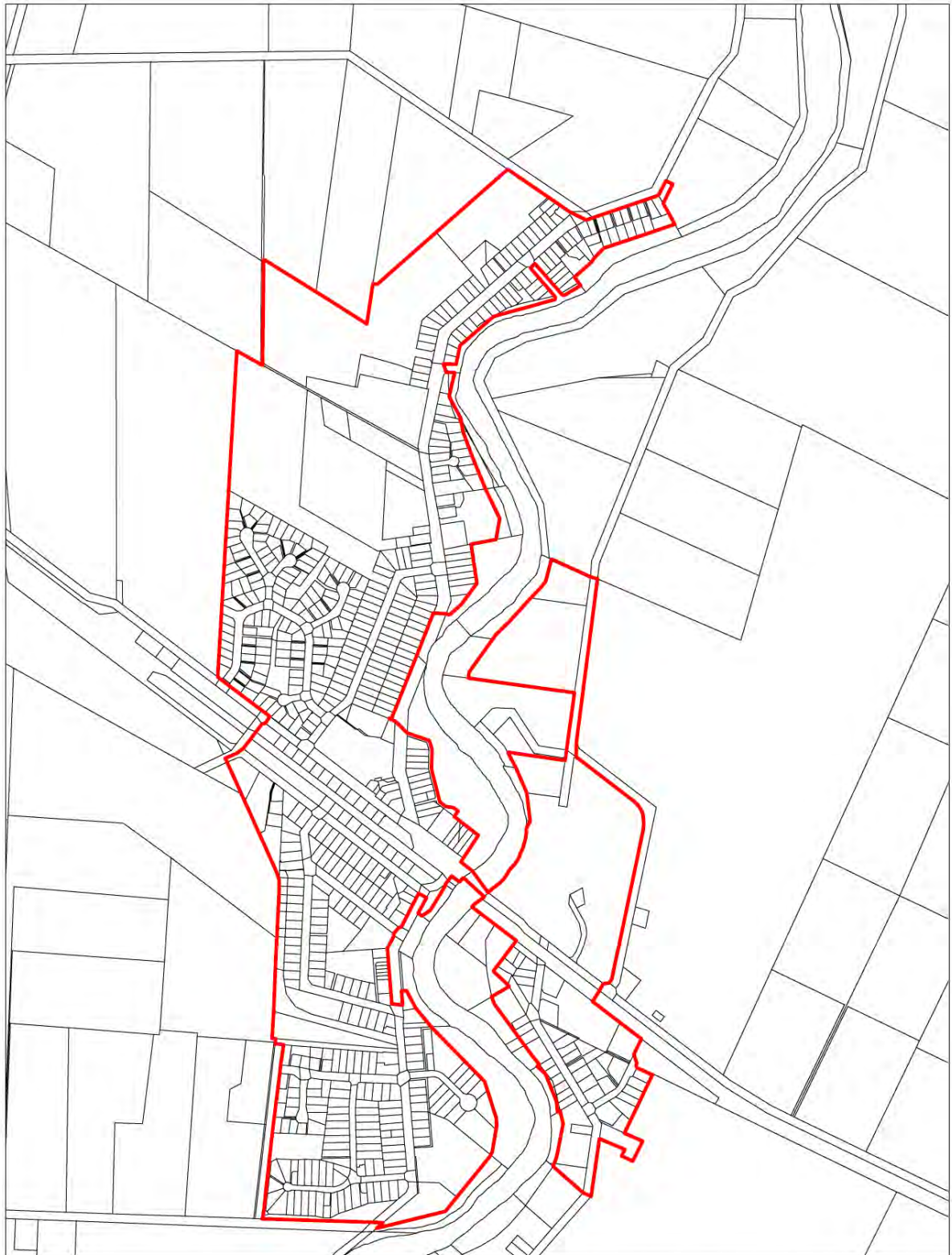

Figure 13.10 Edgecumbe Wastewater Scheme Boundary

Ōtarawāirere



Figure 13.11 Ōtarawāirere Stormwater Scheme Boundary

Murupara



Figure 13.12 Murupara Stormwater Scheme Boundary



Figure 13.13 Murupara Wastewater Scheme Boundary

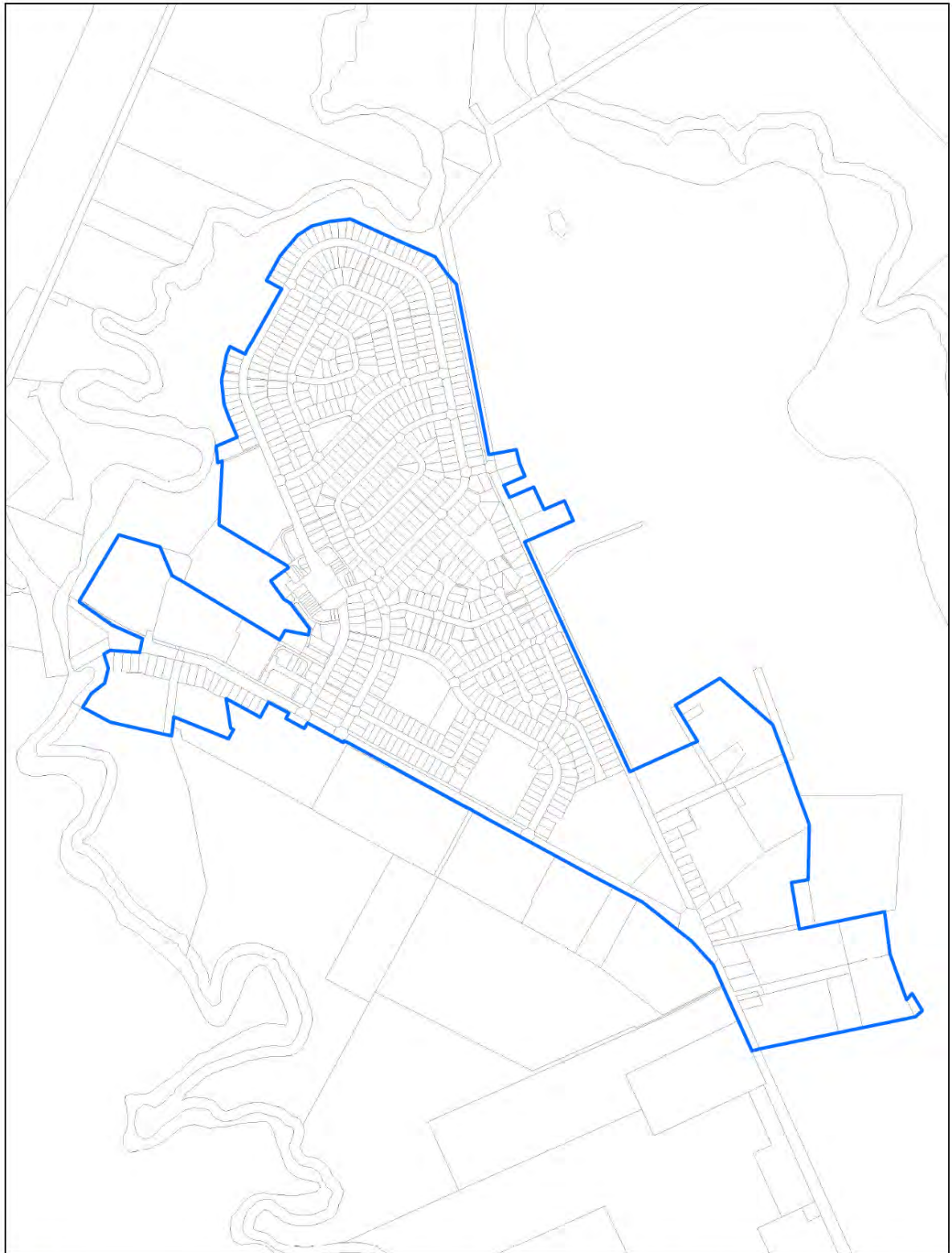

Figure 13.14 Murupara Water Scheme Boundary

Matatā



Figure 13.15 Matatā Stormwater Scheme Boundary



Figure 13.16 Matatā Water Scheme Boundary

Taneātua



Figure 13.17 Taneātua Stormwater Scheme Boundary

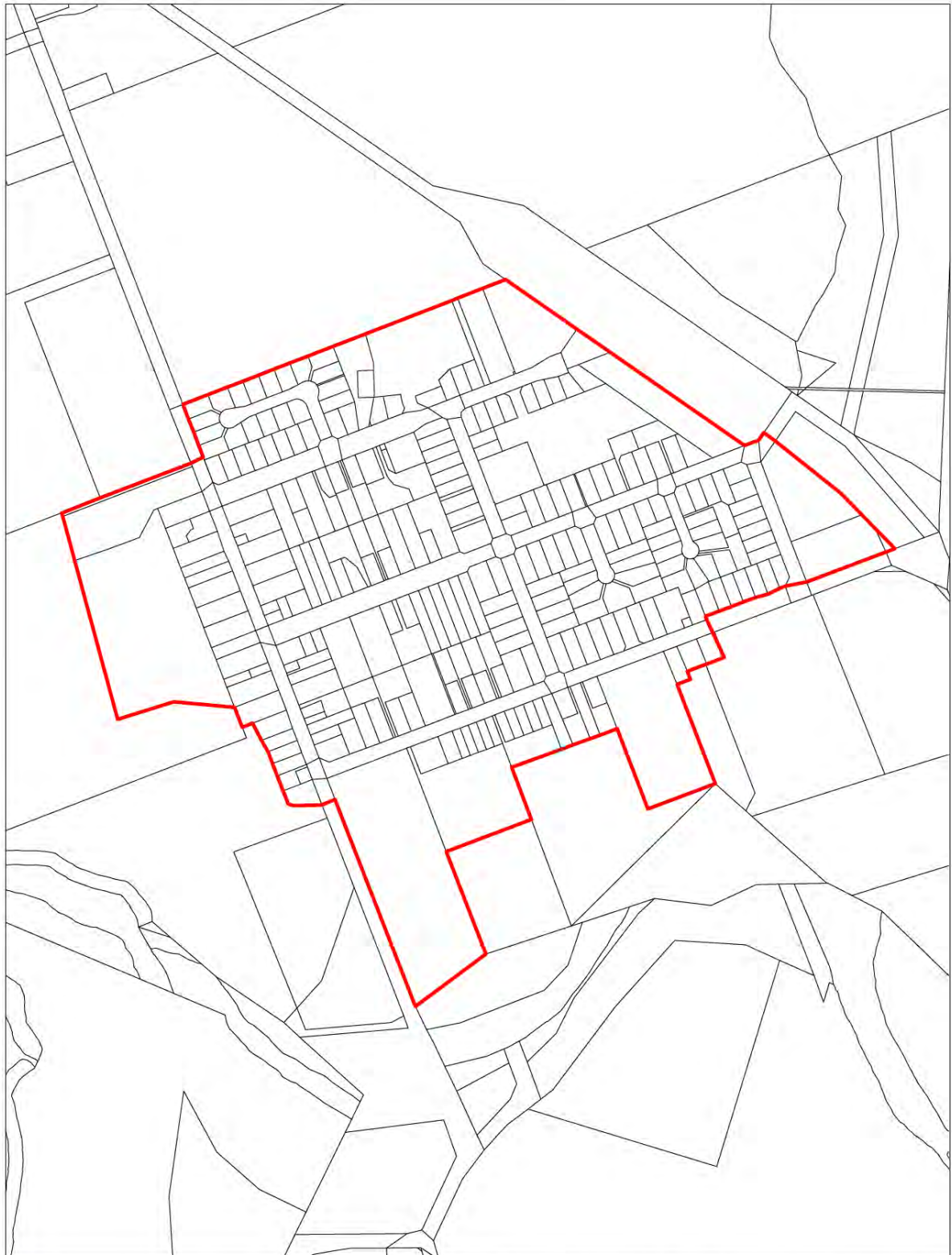

Figure 13.18 Taneātua Wastewater Scheme Boundary

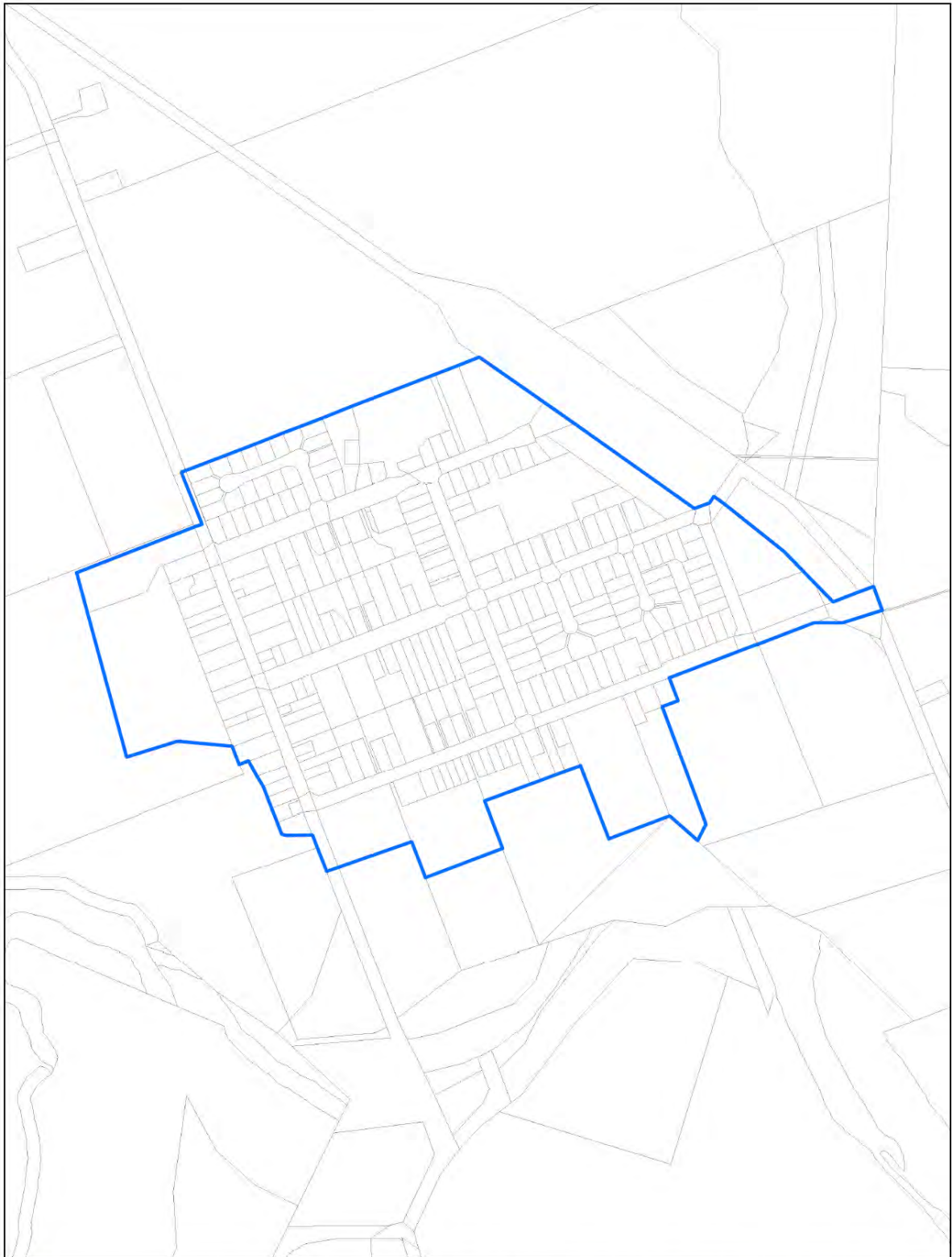

Figure 13.19 Taneātua Water Scheme Boundary

Te Teko



Figure 13.20 Te Teko Stormwater Scheme Boundary

Rangitāiki

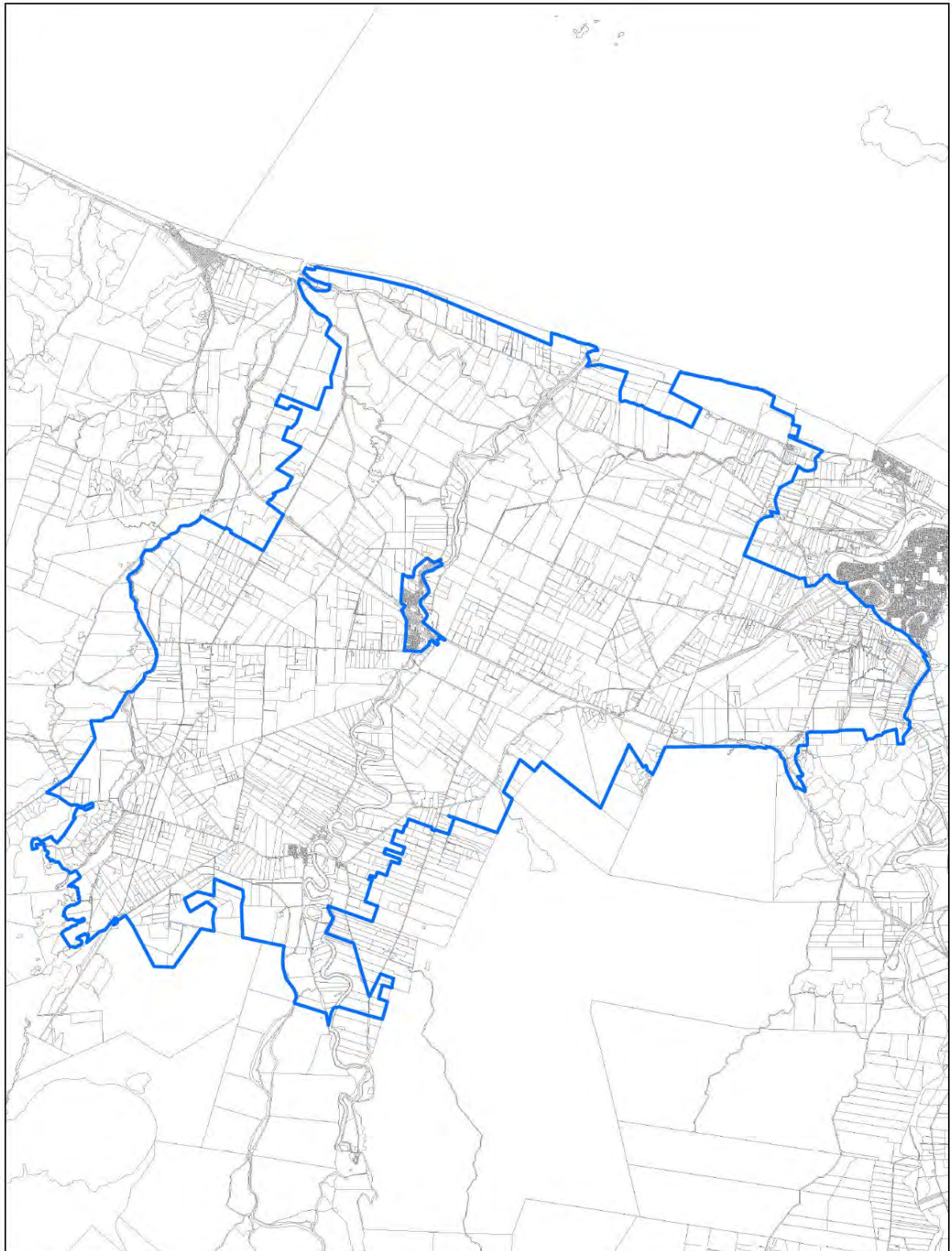

Figure 13.21 Rangitāiki Water Scheme Boundary

Ruatoki

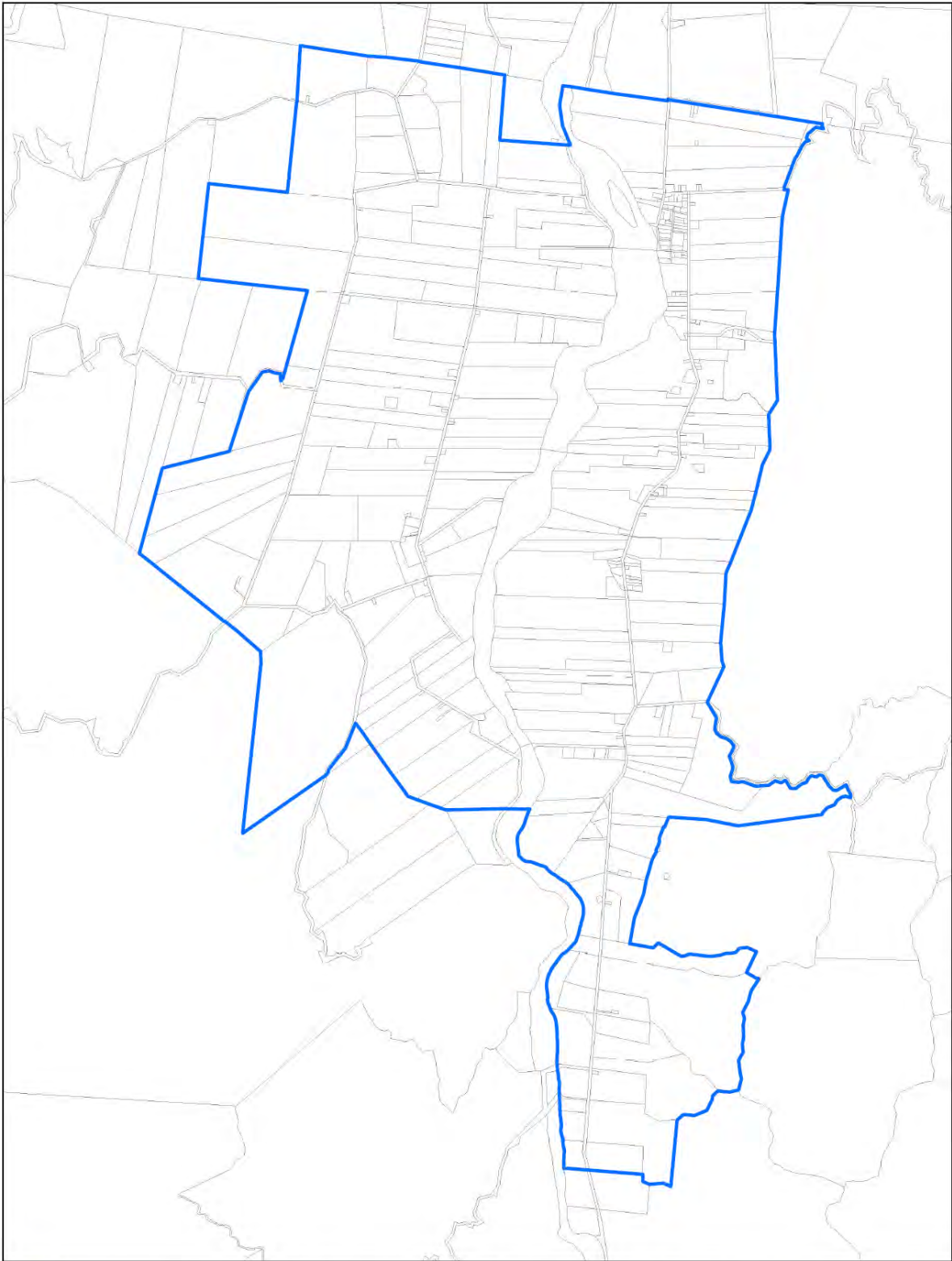

Figure 13.22 Ruatoki Water Scheme Boundary

Te Māhoe

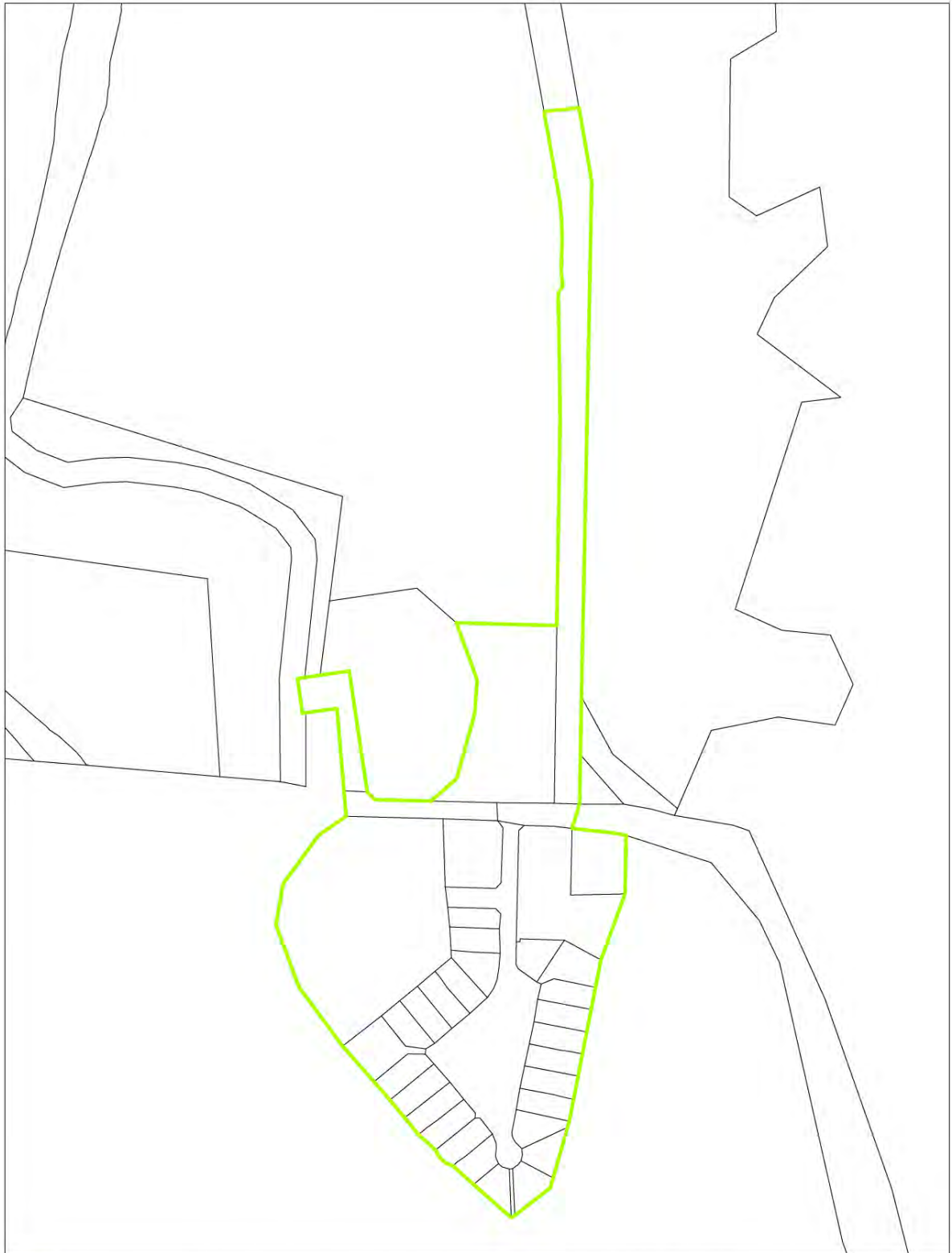

Figure 13.23 Te Māhoe Stormwater Scheme Boundary



Figure 13.24 Te Māhoe Wastewater Scheme Boundary

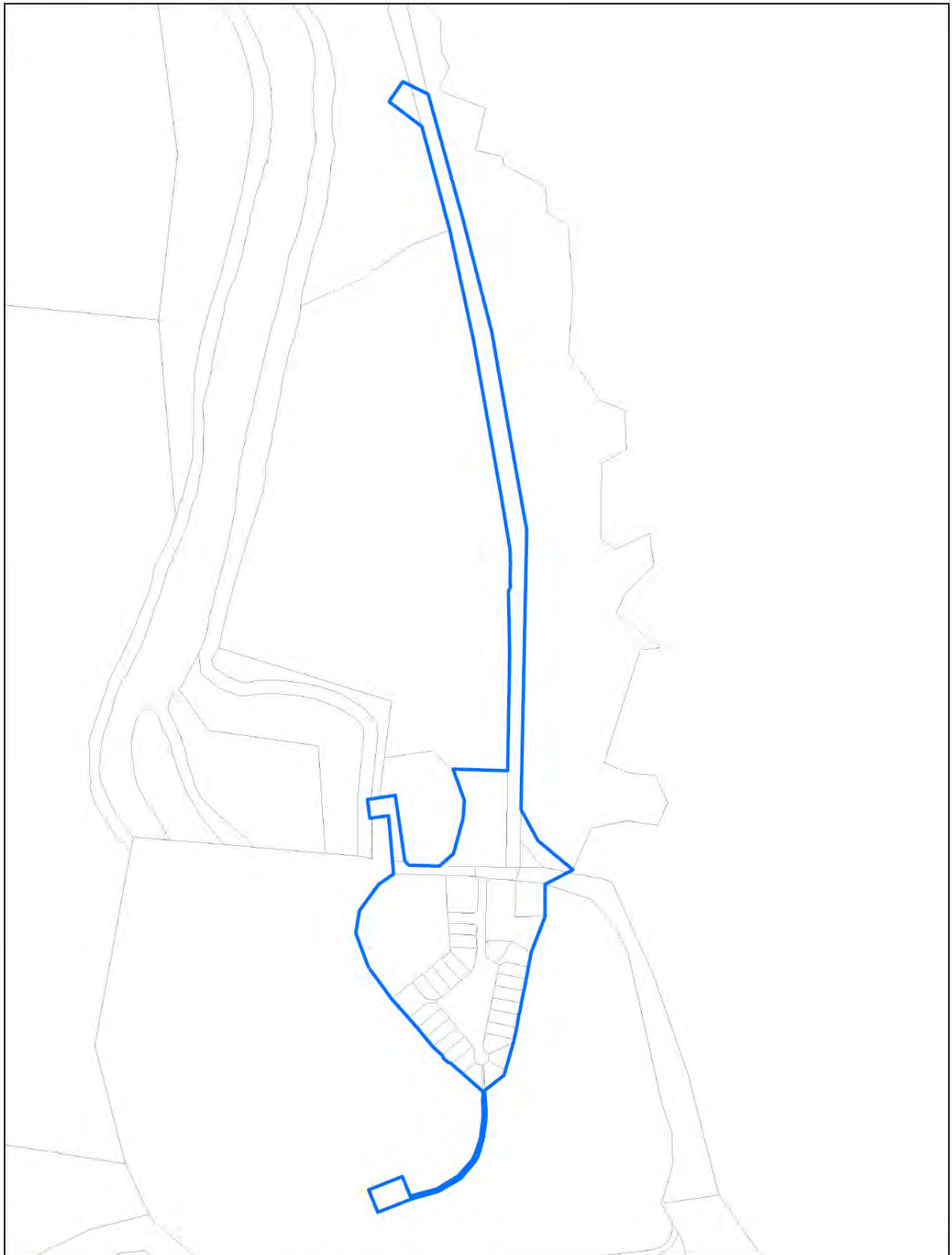
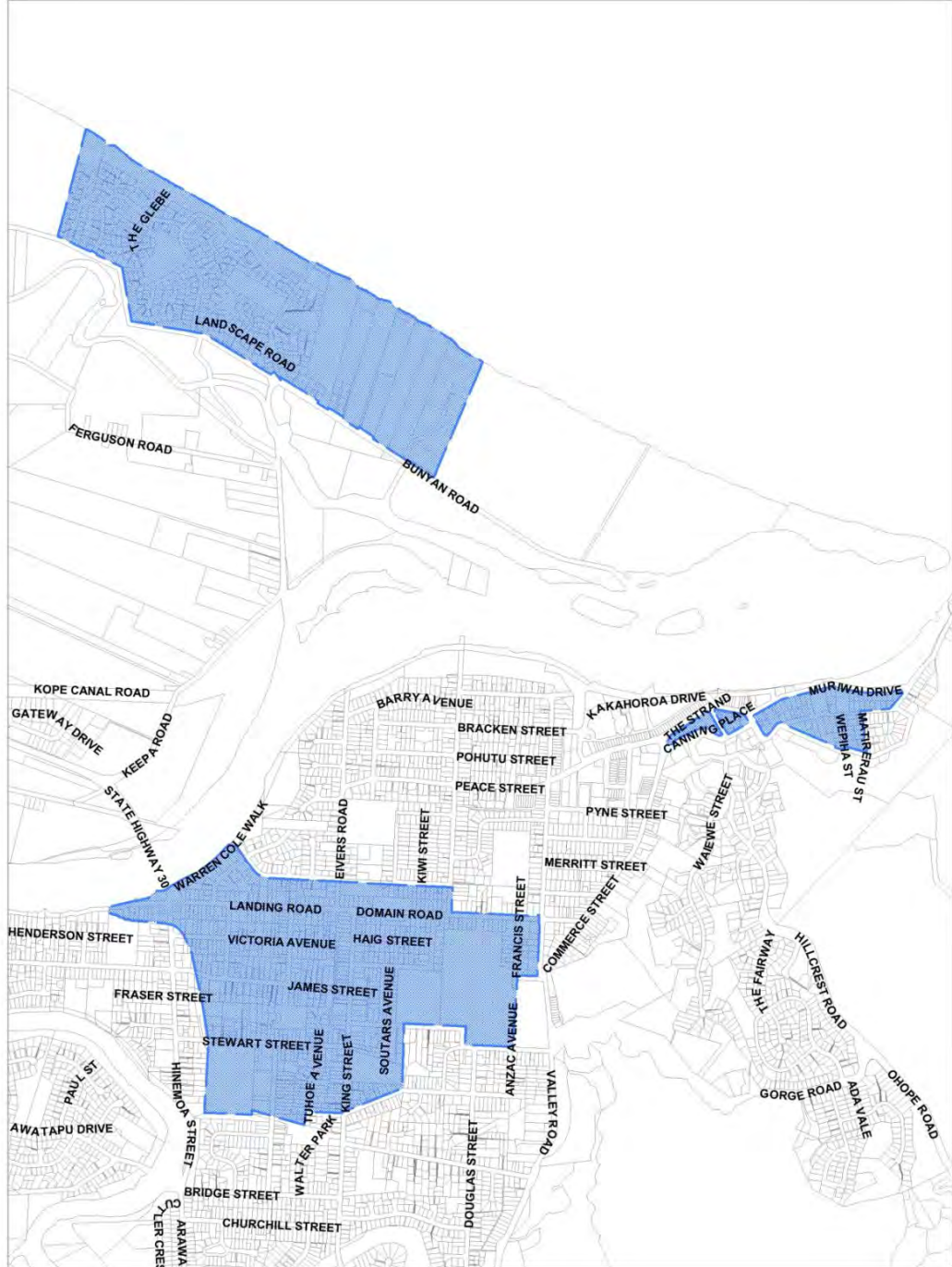

Figure 13.25 Te Māhoe Water Scheme Boundary

13.7.4

Whakatāne Urban Area Ground Soakage Plan (Rule 13.2.28)

Blue shaded areas have good soakage



13.7.5 Road Design Standards Categories of Landuse and Area Types

LAND USE	AREA TYPE			
	RURAL	SUBURBAN	URBAN	CENTRE
<p>LIVE AND PLAY (Residential and parks)</p> <p>Homes, home-based businesses, and mixed use developments with residential uses, as well as parks and low impact recreation.</p> <p><i>Transport: These land uses primarily generate home-based and internal circulation trips (recreation, social, school, and retail). Home-based work trips are concentrated at peak periods, while other types of trips are dispersed across time periods. Streets to these land uses prioritise recreation, walking and cycling over vehicle movement.</i></p>	<p>Low density, generally no more than 4 units per hectare located outside the urban limits.</p> <p><i>Transport: private motor vehicles are the predominant form of transport with low trip volumes throughout the day.</i></p>	<p>Low and moderate density housing generally up to 15 units per hectare in an area where housing is the exclusive or dominant use.</p> <p><i>Transport: Private vehicles are the predominant form of transport but public transport should provide peak period service on arterials and connector/collectors. Non-motorised trips are primarily recreational and occur on local roads.</i></p>	<p>Moderate and high density housing often in combination with other uses such that the combined population of residents, employees, and students is typically 50 per hectare or greater.</p> <p><i>Transport: A higher portion of trips are made on public transport and by walking and cycling. There is lower priority for the provision of residential parking in urban areas.</i></p>	<p>Moderate and high density housing often in combination with other uses such that the combined population of residents, employees, and students is typically 200 per hectare or greater.</p> <p><i>Transport: Residents typically walk or cycle to nearby destinations and rely on public transport for longer trips. And they may choose not to own a vehicle. Provision for residential and commuter parking is a low priority in centres.</i></p>
<p>SHOP AND TRADE (Retail and services)</p> <p>Retail or other service where most trips to the business are by customers and clients, rather than employees.</p> <p><i>Transport: A large volume of destination trips occur across time periods, especially weekends and peak shopping times to these land uses. A low-to-moderate volume of freight truck traffic is served. Streetscapes may serve as connections for destination users to reach several or numerous businesses in the area</i></p>	<p>Isolated or small clusters of stores or service-based businesses located outside the urban limits.</p> <p><i>Transport: Most trips are made in private motor vehicles with low trip volumes throughout the day.</i></p>	<p>Includes both traditional town centres and newer shopping centres of generally 1-2 storeys where the dominant use is retail and services businesses and the combined retail and commercial floor-to-area ratio (FAR) is typically under 0.3 (gross).</p> <p><i>Transport: Most trips are made in private motor vehicles with moderate and high trip volumes, especially on weekends, requiring these land uses to have large amounts of parking allocated to each site.</i></p>	<p>Retail and services focused in a town centre or concentrated along an urban corridor in combination with other uses. The combined population of residents, employees, and students is typically 50 per hectare or greater.</p> <p><i>Transport: Trips are made on a variety of modes at all times with limited amounts of shared and paid parking.</i></p>	<p>Moderate to high density land uses include retail mixed with other uses in an urban or town centre. Centres typically have, or are planned to have, a combined population of residents, employees, and students of 200 per hectare or greater.</p> <p><i>Transport: Public transport services are typically focused on centres, and centres are among the most highly connected and walkable environments. Provision for parking is the lowest land use priority in centres.</i></p>

LAND USE	AREA TYPE			
	RURAL	SUBURBAN	URBAN	CENTRE
<p>WORK AND LEARN (Offices and schools)</p> <p>Areas dominated by businesses or schools where the most important trips to the business are made by employees (typically offices) and students.</p> <p><i>Transport: A large volume of destination trips occur at peak periods on weekdays. A low-to-moderate volume of freight truck traffic is served. Streetscapes may serve as connections for a variety of users, especially during lunch periods as well as other times when clients or customers may visit work places. Roads near schools will require special design needs to accommodate younger pedestrians.</i></p>	<p>Individual or small clusters of activities located outside the urban limits, such as school campuses and research facilities.</p> <p><i>Transport: Most trips are made in private motor vehicles with most trips occurring during peak periods.</i></p>	<p>Low rise office buildings (typically 1-2 storeys) and school campuses with an area wide average FAR of less than 0.3, including any retail component.</p> <p><i>Transport: Most trips are made in private motor vehicles during peak periods, requiring these land uses to have large amounts of parking allocated to each site.</i></p>	<p>Low and mid-rise office buildings that often include street-front retail and services focused in a town centre or concentrated along an urban corridor. The combined population of residents, employees, and students is typically 50 per hectare or greater.</p> <p><i>Transport: trips are made on a variety of modes at all times with limited amounts of shared and paid parking.</i></p>	<p>Mid-rise and high-rise office buildings that usually include mixed uses, including street-front retail and multi-family housing. Centres typically have, or are planned to have, a combined population of residents, employees, and students of 200 per hectare or greater.</p> <p><i>Transport: Public transport services are typically focused on centres, and centres are among the most highly connected and walkable environments. Provision for parking is the lowest land use priority in centres.</i></p>
<p>MAKE, GROW AND MOVE (Agriculture, industrial, and warehouses)</p> <p>Areas dominated by businesses where the most important trips to the business are made by heavy delivery trucks (typically farms, warehouses, and industries).</p> <p><i>Transport: A moderate-to-large volume of freight trips occur (year around or seasonally) and should be accommodated in the road link network. Streetscapes are designed to accommodate heavy freight movements. Where these are larger in number and need to be served, the freight, link function is crucial to service the land use function.</i></p>	<p>Farms, light industry, and warehouses located outside the urban limits.</p> <p><i>Transport: Road links are predominantly designed to accommodate freight truck movements and those generated by employees and business customers. Special vehicle areas may be provided to accommodate specialised freight needs.</i></p>	<p>Industrial parks.</p> <p><i>Transport: Road links are predominantly designed to accommodate freight truck movements and those generated by employees and business customers. Parking may also be provided for some employees, and special vehicle areas may be provided to accommodate specialised freight needs.</i></p>	<p>Would not normally occur except where activities have little impact on or otherwise support surrounding land uses.</p>	<p>Would not normally occur except where activities have little impact on or otherwise support surrounding land uses.</p>

13.7.6 Road Design Standards by Landuse and Area Type

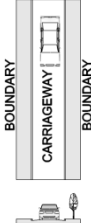
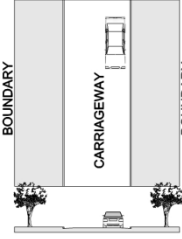

Place context			Design environment				Link context					Typical plan and cross section
Area	Land use	Local attributes	Locality served	Target operating speed (km/h)	Minimum road width (m)	Max. grade	Pedestrians	Passing, parking, loading and shoulder	Cyclists	Movement lane (excluding shoulder)	Classification	
Rural	Live & play											Lane
Suburban	Shop & trade											Local road
Urban	Work & learn											Connector/ collector
Centre	Make & move											
											(Typical maximum volumes)	
Rural	Live and play	Access to lifestyle or clustered housing	1 to 6 du	20	6	20%	Shared (on shoulder and berm)	Allow for passing up to every 50 m, total shoulder 0.5 m, sealed	Shared (in movement lane)	2.50	Lane (this would normally be a private road or private way)	
		Access to lifestyle or clustered housing	1 to 20 du	30	9	16%	Shared (on shoulder and berm)	Total shoulder 0.5 m, sealed	Shared (in movement lane)	5.5 - 5.7	Lane (~200 vpd)	

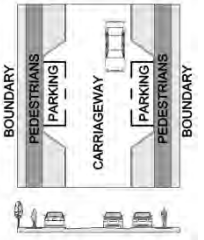
Place context			Design environment				Link context					Typical plan and cross section
Area	Land use	Local attributes	Locality served	Target operating speed (km/h)	Minimum road width (m)	Max. grade	Pedestrians	Passing, parking, loading and shoulder	Cyclists	Movement lane (excluding shoulder)	Classification	
Rural Suburban Urban Centre	Live & play Shop & trade Work & learn Make & move										Lane Local road Connector/ collector	
											(Typical maximum volumes)	
		Access to housing	1 to 150 du	70	15	12.5%	Shared (on shoulder and berm)	Total shoulder 1.0 m, sealed shoulder 0.5 m	Shared (in movement lane)	5.5 - 5.7	Local road (~ 1000 vpd)	<p>The diagram shows a cross-section of a road. It features a central 'CARRIAGEWAY' with a car icon. On either side of the carriageway are vertical bars labeled 'BOUNDARY'. Below the carriageway, there are small tree icons and a car icon on the road surface.</p>

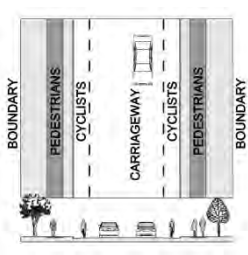
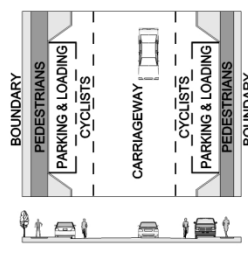
Place context			Design environment				Link context					Typical plan and cross section
Area	Land use	Local attributes	Locality served	Target operating speed (km/h)	Minimum road width (m)	Max. grade	Pedestrians	Passing, parking, loading and shoulder	Cyclists	Movement lane (excluding shoulder)	Classification	
Rural Suburban Urban Centre	Live & play Shop & trade Work & learn Make & move										Lane Local road Connector/ collector	
											(Typical maximum volumes)	
Rural	Shop and trade	Side or rear service access	Up to 100 m in length between streets, 1 to 20 lots	10	6	16%	Shared (in movement lane)	Allow for passing up to every 50 m. Kerbed edge or total shoulder 0.5 m, sealed	Shared (in movement lane)	2.75 - 3.00	Lane (~ 200 vpd)	
		Access to trade	Rural village shops	40	15	10%	1.5 m each side	Parking and loading may occur in the movement lane or be separate and recessed. Kerbed edge or total shoulder 1.0 m, sealed shoulder 0.5 m	Shared (in movement lane)	5.5 - 5.7	Local road (~ 1,000 vpd)	

Place context			Design environment				Link context					Typical plan and cross section	
Area	Land use	Local attributes	Locality served	Target operating speed (km/h)	Minimum road width (m)	Max. grade	Pedestrians	Passing, parking, loading and shoulder	Cyclists	Movement lane (excluding shoulder)	Classification		
Rural Suburban Urban Centre	Live & play Shop & trade Work & learn Make & move										Lane Local road Connector/ collector		
											(Typical maximum volumes)		
Rural	Make and move	Primary freight access	Rural activities	up to 100	20	10%	1.5 m each side	Total shoulder 1.0 m, sealed shoulder 0.5 m		On sealed shoulder where it is a local authority defined cycle route.	5.5 - 5.7	Local road (~ 1,000 vpd)	
		Access to office and education	1 to 200 lots	up to 60	20	10%	1.5 m each side	Parking and loading may occur in movement lane or be separate and recessed. Total shoulder 1.0 m, sealed shoulder 0.5 m		On sealed shoulder where it is a local authority defined cycle route.	5.5 - 5.7	Local road (~ 1,000 vpd)	

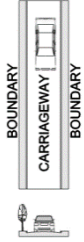
Place context			Design environment				Link context					Typical plan and cross section
Area	Land use	Local attributes	Locality served	Target operating speed (km/h)	Minimum road width (m)	Max. grade	Pedestrians	Passing, parking, loading and shoulder	Cyclists	Movement lane (excluding shoulder)	Classification	
Rural Suburban Urban Centre	Live & play Shop & trade Work & learn Make & move										Lane Local road Connector/collector	
											(Typical maximum volumes)	
	All other situations (where not specified elsewhere)	All (serving land uses not specified elsewhere in this table)	-	up to 100	20	10%	Separate from the carriageway, 1.5 m each side	Total shoulder 1.5 m, sealed shoulder 1.0 m	On sealed shoulder where it is a local authority defined cycle route.	5.5 - 5.7	Connector/collector (~ 2,500 vpd)	<p>The diagram shows a cross-section of a road with the following elements from left to right: a Boundary, a Pedestrians lane, a Cyclists lane, a Carriageway, another Cyclists lane, another Pedestrians lane, and another Boundary. Small icons of a person, a bicycle, and a car are placed within their respective lanes.</p>

Place context			Design environment				Link context					Typical plan and cross section
Area	Land use	Local attributes	Locality served	Target operating speed (km/h)	Minimum road width (m)	Max. grade	Pedestrians	Passing, parking, loading and shoulder	Cyclists	Movement lane (excluding shoulder)	Classification	
Rural	Live & play										Lane	
Suburban	Shop & trade										Local road	
Urban	Work & learn										Connector/ collector	
Centre	Make & move											
											(Typical maximum volumes)	
Suburban	Live and play	Access to houses/ townhouses	1 to 3 du or 1 to 6 du	10	3.6m for up to 3 du or 4.5m for up to 6 du	20%	Shared (in movement lane)	Allow for passing up to every 50 m	Shared (in movement lane)	2.75 - 3.0	Lane (this would normally be a private road or private way)	
		Side or rear service access	Up to 100 m in length between streets, 1 to 20 lots	10	6	16%	Shared (in movement lane)	Allow for passing up to every 50 m	Shared (in movement lane)	2.75 - 3.00	Lane (~ 200 vpd)	

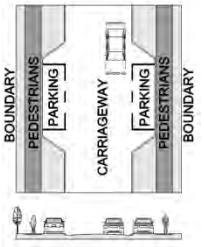
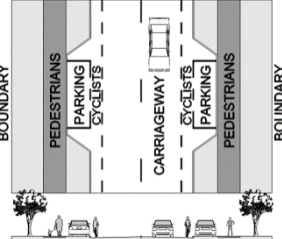

Place context			Design environment				Link context					Typical plan and cross section
Area	Land use	Local attributes	Locality served	Target operating speed (km/h)	Minimum road width (m)	Max. grade	Pedestrians	Passing, parking, loading and shoulder	Cyclists	Movement lane (excluding shoulder)	Classification	
Rural Suburban Urban Centre	Live & play Shop & trade Work & learn Make & move										Lane Local road Connector/ collector	
											(Typical maximum volumes)	
		Access to houses/ townhouses	1 to 20 du	20	9	16%	Shared (in movement lane)	Shared (in movement lane).	Shared (in movement lane)	5.5 - 5.7	Lane (~ 200 vpd)	

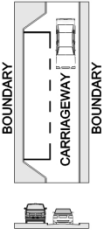
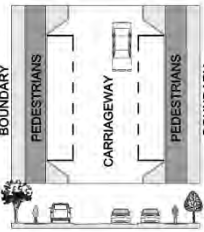
Place context			Design environment				Link context					Typical plan and cross section
Area	Land use	Local attributes	Locality served	Target operating speed (km/h)	Minimum road width (m)	Max. grade	Pedestrians	Passing, parking, loading and shoulder	Cyclists	Movement lane (excluding shoulder)	Classification	
Rural	Live & play										Lane	
Suburban	Shop & trade										Local road	
Urban	Work & learn										Connector/ collector	
Centre	Make & move											
											(Typical maximum volumes)	
Suburban	Live and play	Primary access to housing	1 to 200 du	40	15	12.5%	1.5 m one side or 1.5 m each side where more than 20 du or more than 100 m in length	Shared parking in the movement lane up to 100 du, separate parking required over 100 du	Shared (in movement lane)	5.5 - 5.7	Local road (~ 2,000 vpd)	
		Primary access to housing	Up to 800 du	50	20	10%	2.0 m each side	Parking is separate and recessed. Public transport is likely.	Separate provision where local authority defined cycle route.	2 x 4.2	Connector/ collector (~ 8,000 vpd)	

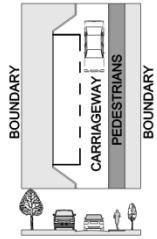
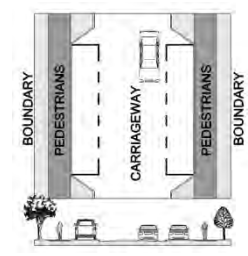
Place context			Design environment				Link context					Typical plan and cross section
Area	Land use	Local attributes	Locality served	Target operating speed (km/h)	Minimum road width (m)	Max. grade	Pedestrians	Passing, parking, loading and shoulder	Cyclists	Movement lane (excluding shoulder)	Classification	
Rural	Live & play										Lane	
Suburban	Shop & trade										Local road	
Urban	Work & learn										Connector/ collector	
Centre	Make & move											
											(Typical maximum volumes)	
Suburban	Shop and trade, work and learn	Side or rear service access	Suburban village, access to office and education, 1 - 20 lots	10	6	10%	Shared (in movement lane)	Recessed loading bays.	Shared (in movement lane)	3.5	Lane (~ 200 vpd)	
		Access to trade, office and education	Suburban village 1 - 200 lots	40	18	10%	3.0 m each side	Parking and loading bays both sides may be in the movement lane or recessed.	Shared (in movement lane)	5.5 - 5.7	Local road (~ 2,000 vpd)	

Place context			Design environment				Link context					Typical plan and cross section
Area	Land use	Local attributes	Locality served	Target operating speed (km/h)	Minimum road width (m)	Max. grade	Pedestrians	Passing, parking, loading and shoulder	Cyclists	Movement lane (excluding shoulder)	Classification	
Rural	Live & play										Lane	
Suburban	Shop & trade										Local road	
Urban	Work & learn										Connector/ collector	
Centre	Make & move											
											(Typical maximum volumes)	
Suburban	Make and move	Side or rear freight access	Industrial area	10	11	10%	Separate footpath one side	Loading bays shall be separate and recessed.	Shared (in movement lane)	3.5	Lane (~ 200 vpd)	
		Primary freight access	Industrial area	40	18	10%	1.5 m each side	Parking and loading bays both sides may be in the movement lane or recessed.	Shared (in movement lane)	2 x 4.2	Local road (~2,000 vpd)	

Place context			Design environment				Link context					Typical plan and cross section
Area	Land use	Local attributes	Locality served	Target operating speed (km/h)	Minimum road width (m)	Max. grade	Pedestrians	Passing, parking, loading and shoulder	Cyclists	Movement lane (excluding shoulder)	Classification	
Rural	Live & play										Lane	
Suburban	Shop & trade										Local road	
Urban	Work & learn										Connector/collector	
Centre	Make & move											
											(Typical maximum volumes)	
	Shop and trade, work and learn, make and move	All, roads serving multi-purpose areas involving most or all of the indicated land uses, not specified elsewhere in this table.	All, or combinations of these land uses	50	23	10%	2.5 m each side, 3.5 m each side for shop and trade, work and learn	Parking separate and recessed. Public transport is likely.	Separate provision where local authority defined cycle route.	2 x 4.2	Connector/collector (~ 8,000 vpd)	

Place context			Design environment				Link context					Typical plan and cross section
Area	Land use	Local attributes	Locality served	Target operating speed (km/h)	Minimum road width (m)	Max. grade	Pedestrians	Passing, parking, loading and shoulder	Cyclists	Movement lane (excluding shoulder)	Classification	
Rural	Live & play										Lane	
Suburban	Shop & trade										Local road	
Urban	Work & learn										Connector/collector	
Centre	Make & move											
											(Typical maximum volumes)	
Urban	Live and play	Access to lifestyle or clustered housing	1 to 3 du or 1 to 6 du	10	3.6m for up to 3 du or 4.5m for up to 6 du	20%	Shared (in movement lane)	Allow for passing up to every 50 m	Shared (in movement lane)	2.75 - 3.0	Lane (this would normally be a private road or private way)	
		Side or rear service access	1 to 20 du	10	6	16%	Shared (in movement lane)	Parking is required and shall be separate and recessed.	Shared (in movement lane)	2.75 - 3.00	Lane (~200 vpd)	

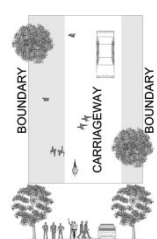
Place context			Design environment				Link context					Typical plan and cross section
Area	Land use	Local attributes	Locality served	Target operating speed (km/h)	Minimum road width (m)	Max. grade	Pedestrians	Passing, parking, loading and shoulder	Cyclists	Movement lane (excluding shoulder)	Classification	
Rural Suburban Urban Centre	Live & play Shop & trade Work & learn Make & move										Lane Local road Connector/ collector	
											(Typical maximum volumes)	
		Access to houses / townhouses	1 to 20 du	20	9	16%	Shared (in movement lane)	Shared (in movement lane)	Shared (in movement lane)	5.5 - 5.7	Lane (~ 200 vpd)	

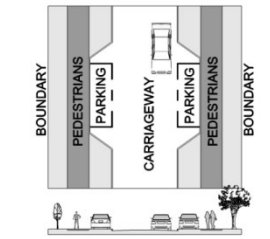
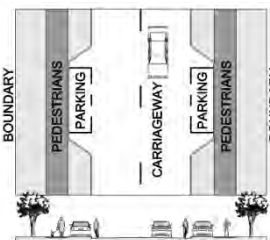
Place context			Design environment				Link context					Typical plan and cross section
Area	Land use	Local attributes	Locality served	Target operating speed (km/h)	Minimum road width (m)	Max. grade	Pedestrians	Passing, parking, loading and shoulder	Cyclists	Movement lane (excluding shoulder)	Classification	
Rural	Live & play										Lane	
Suburban	Shop & trade										Local road	
Urban	Work & learn										Connector/collector	
Centre	Make & move											
											(Typical maximum volumes)	
Urban	Live and play	Primary access to housing	1 to 200 du	30	15	12.5%	1.5 m one side or 1.5 m both sides where more than 20 du or more than 100 m in length	Parking may occur in the movement lane or be separate and recessed.	Shared (in movement lane)	5.5 - 5.7	Local road (~ 2,000 vpd)	
		All other "land use" activity types within this "Area" type not specified elsewhere in this table.	All	50	20	10%	2.0 m each side	Parking separate and recessed. Public transport is likely.	Separate provision where local authority defined cycle route	2 x 4.2	Connector/collector (~ 8,000 vpd)	

Place context			Design environment				Link context					Typical plan and cross section
Area	Land use	Local attributes	Locality served	Target operating speed (km/h)	Minimum road width (m)	Max. grade	Pedestrians	Passing, parking, loading and shoulder	Cyclists	Movement lane (excluding shoulder)	Classification	
Rural Suburban Urban Centre	Live & play Shop & trade Work & learn Make & move										Lane Local road Connector/ collector	
											(Typical maximum volumes)	
	Shop and trade	Side or rear service access	1 to 20 lots	10	6	16%	Shared (in movement lane)	Loading bays shall be recessed.	Shared (in movement lane)	2.75 - 3.00	Lane (~ 200 vpd)	

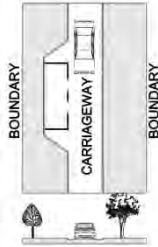
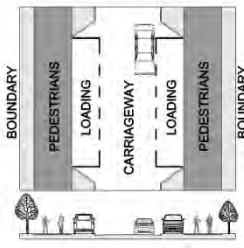
Place context			Design environment				Link context					Typical plan and cross section
Area	Land use	Local attributes	Locality served	Target operating speed (km/h)	Minimum road width (m)	Max. grade	Pedestrians	Passing, parking, loading and shoulder	Cyclists	Movement lane (excluding shoulder)	Classification	
Rural	Live & play										Lane	
Suburban	Shop & trade										Local road	
Urban	Work & learn										Connector/ collector	
Centre	Make & move											
											(Typical maximum volumes)	
Urban	Shop and trade	Access to lots or shop or trade units	1 to 20 lots	10	11	12%	Shared (in movement lane)	Parking may occur separate and recessed.	Shared (in movement lane)	2.75 - 3.00	Lane (~ 200 vpd)	
		Primary access to trade	1 to 200 lots	30	20	10%	3.5 m each side	Parking and loading bays may occur in the movement lane or be separate and recessed.	Shared (in movement lane)	5.5 - 5.7	Local road (~ 2,000 vpd)	

Place context			Design environment				Link context					Typical plan and cross section
Area	Land use	Local attributes	Locality served	Target operating speed (km/h)	Minimum road width (m)	Max. grade	Pedestrians	Passing, parking, loading and shoulder	Cyclists	Movement lane (excluding shoulder)	Classification	
Rural	Live & play										Lane	
Suburban	Shop & trade										Local road	
Urban	Work & learn										Connector/ collector	
Centre	Make & move											
											(Typical maximum volumes)	
Urban	Work and learn	Side or rear service access	1 to 20 lots	10	6	16%	Shared (in movement lane)	Parking and loading bays shall be separate and recessed.	Shared (in movement lane)	2.75 - 3.00	Lane (~ 200 vpd)	
		Access to lots or work or learn activities	1 to 20 lots	10	11	12%	Shared (in movement lane)	Parking and loading bays shall be separate and recessed.	Shared (in movement lane)	2.75 - 3.00	Lane (~ 200 vpd)	

Place context			Design environment				Link context					Typical plan and cross section
Area	Land use	Local attributes	Locality served	Target operating speed (km/h)	Minimum road width (m)	Max. grade	Pedestrians	Passing, parking, loading and shoulder	Cyclists	Movement lane (excluding shoulder)	Classification	
Rural Suburban Urban Centre	Live & play Shop & trade Work & learn Make & move										Lane Local road Connector/ collector	
											(Typical maximum volumes)	
		Primary access to office and education	1 to 200 lots	30	20	10%	3.5 m each side	Parking and loading bays may occur in the movement lane or be separate and recessed.	Shared (in movement lane)	5.5 - 5.7	Local road (~ 2,000 vpd)	<p>The diagram shows a cross-section of a road. From left to right: a boundary, a pedestrian zone, a parking area, a central carriageway with a car icon, another parking area, another pedestrian zone, and a final boundary. Below this, a perspective view shows a road with trees and cars.</p>

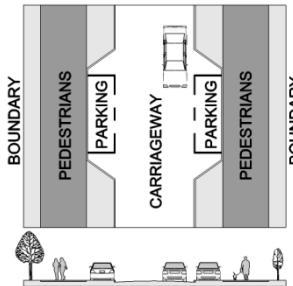
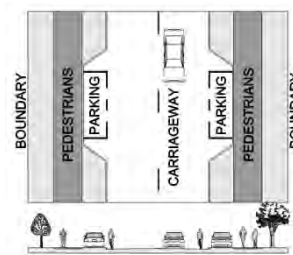
Place context			Design environment				Link context					Typical plan and cross section
Area	Land use	Local attributes	Locality served	Target operating speed (km/h)	Minimum road width (m)	Max. grade	Pedestrians	Passing, parking, loading and shoulder	Cyclists	Movement lane (excluding shoulder)	Classification	
Rural	Live & play										Lane	
Suburban	Shop & trade										Local road	
Urban	Work & learn										Connector/collector	
Centre	Make & move											
											(Typical maximum volumes)	
Urban	Mixed use	Multiple user access	1 to 200 lots	30	20	10%	3.5 m each side	Parking and loading bays may occur in the movement lane or be separate and recessed.	Shared (in movement lane)	5.5 - 5.7	Local road (~2,000 vpd)	
		Neighbourhood centres (and all other areas serving multiple land uses not listed elsewhere in this table)	200 to 800 lots	50	23	10%	2.5 m each side	Parking is preferred separate and recessed. Public transport is likely.	Separate provision where local authority defined cycle route.	2 x 4.2	Connector/collector (~8,000 vpd)	

13.7.7 Whakatāne and Galatea Airport Approach Path Protection

Overview

- (a) The following height restrictions are based on Civil Aviation Authority Advisory Circular 139.06A obstacle limitation surfaces for aircraft with a maximum certified take off weight greater than 5,700 kg operating under non-precision approach conditions.
- (b) All measurements are in metres above average mean sea level unless otherwise stated.

Runway and Runway Strip

The runway (09-27) is 1,280 m long x 30.5 m wide and orientated on a bearing of 114°31'14.9". The runway strip is 1,400 m long and 140 m wide and contains the runway within it. For purposes of defining obstacle limitation surfaces, a 150 m runway strip width is assumed.

Airport Protection

Height restrictions associated with the runway strips, take-off climb and approach surfaces, transitional surfaces, horizontal and conical surfaces are defined below and shown on Figure 13.27 and 13.28.

Height Restriction

- *Take-off Climb and Approach Surfaces*

There is a take-off climb and approach protection surface at each end of the main runway strip. The take-off and approach surfaces differ in detail, but both are protected by a slope extending upward and outward from each end of the strip.

Each take-off climb and approach protection surface extends over a horizontal distance specified below and is symmetrically disposed about the centreline of the flight protection surface, with its sides diverging uniformly outwards from each end of the length of the inner edge at each strip end. For the runway the length of the inner edge is 75 m either side of the runway centreline.

Take-off Surface

The take-off surface at each end of the strip rises at a gradient of 1.6% (1v:62.5h) over a horizontal distance of 15,000 m and continues along the extended runway centreline. The rate of lateral divergence for both sides of the surface is 12.5% (1v:8h) until a final width of 1,200 m is attained, the surface then continues at this width.

Approach Surface

The approach surface at each end of the strip rises at a gradient of 2.5% (1v:40h) over a horizontal distance of 15,000 m and continues along the extended runway centreline. The rate of lateral divergence for both sides of the surface is 15% (1v:6.6h) for the full 15,000 m length.

- *Transitional Surfaces*

The transitional surface provides for a situation where an approaching aircraft is either off centreline or where it has executed a missed approach and allows for an area free of obstacles to protect aircraft in the final phase of the approach to land manoeuvre.

The transitional surfaces extend upwards and outwards from the sides of the main runway strip at a gradient of 14.3% (1v:7h) until they reach the horizontal surface. The transitional surfaces also extend at the same heights beyond each end of the runway strip to intercept the approach surface.

- *Inner Horizontal Surface*

The inner horizontal surface is a plane surface at a height of 45 m above the aerodrome datum level of 6m enclosed within a 4,000 m radius drawn from the periphery of the runway strip, and a 4,000 m distance either side of the runway strip.

- *Conical Surface*

The conical surface extends from the periphery of the inner horizontal surface upwards and outwards at a slope of 5% (1v:20h) to a height of 150 m above the aerodrome datum level of 6m.

Note: Where ground rises so that it penetrates or becomes close to the take-off climb, approach, inner horizontal or conical surface, then this surface may be adjusted in conformity with the ground to provide a vertical clearance of 10.7 m above **ground level**.

2. GALATEA AIRPORT

Overview

- (a) The following height restrictions are based on Civil Aviation Authority Advisory Circular 139.07A obstacle limitation surfaces for aircraft with a maximum certified take off weight less than 5,700 kg operating under Day—VFR conditions.
- (b) All measurements are in metres above average mean sea level unless otherwise stated.

Runway and Runway Strip

The runway strip (01-19) is 1,025 m long x 60 m wide and is orientated on a bearing of 31°37'58.4".

Airport Protection

Height restrictions associated with the runway strips, take-off climb and approach surfaces, and transitional surfaces are defined below and shown on Maps 31 and 32.

Height Restriction

- *Take-off Climb and Approach Surfaces*

There is a take-off climb and approach protection surface at each end of the main runway strip. The take-off and approach surfaces have the same detail and are protected by a slope extending upward and outward from each end of the strip.

Each take-off climb and approach protection surface extends over a horizontal distance specified below and is symmetrically disposed about the centreline of the flight protection surface, with its sides diverging uniformly outwards from each end of the length of the inner edge at each strip end. For the runway the length of the inner edge is 30 m either side of the runway centreline.

- *Take-off/Approach Surface*

The take-off/approach surface at each end of the strip rises at a gradient of 5% (1v:20h) over a horizontal distance of 1,200 m and continues along the extended runway centreline. The rate of lateral divergence for both sides of the surface is 5% (1v:20h) for the full 1,200 m length.

- *Transitional Surfaces*

The transitional surface provides for a situation where an approaching aircraft is either off centreline or where it has executed a missed approach and allows for an area free of obstacles to protect aircraft in the final phase of the approach to land manoeuvre.

The transitional surfaces extend upwards and outwards from the sides of the main runway strip at a gradient of 14.3% (1v:7h) until they reach the horizontal surface. The transitional surfaces also extend at the same heights beyond each end of the runway strip to intercept the approach surface.

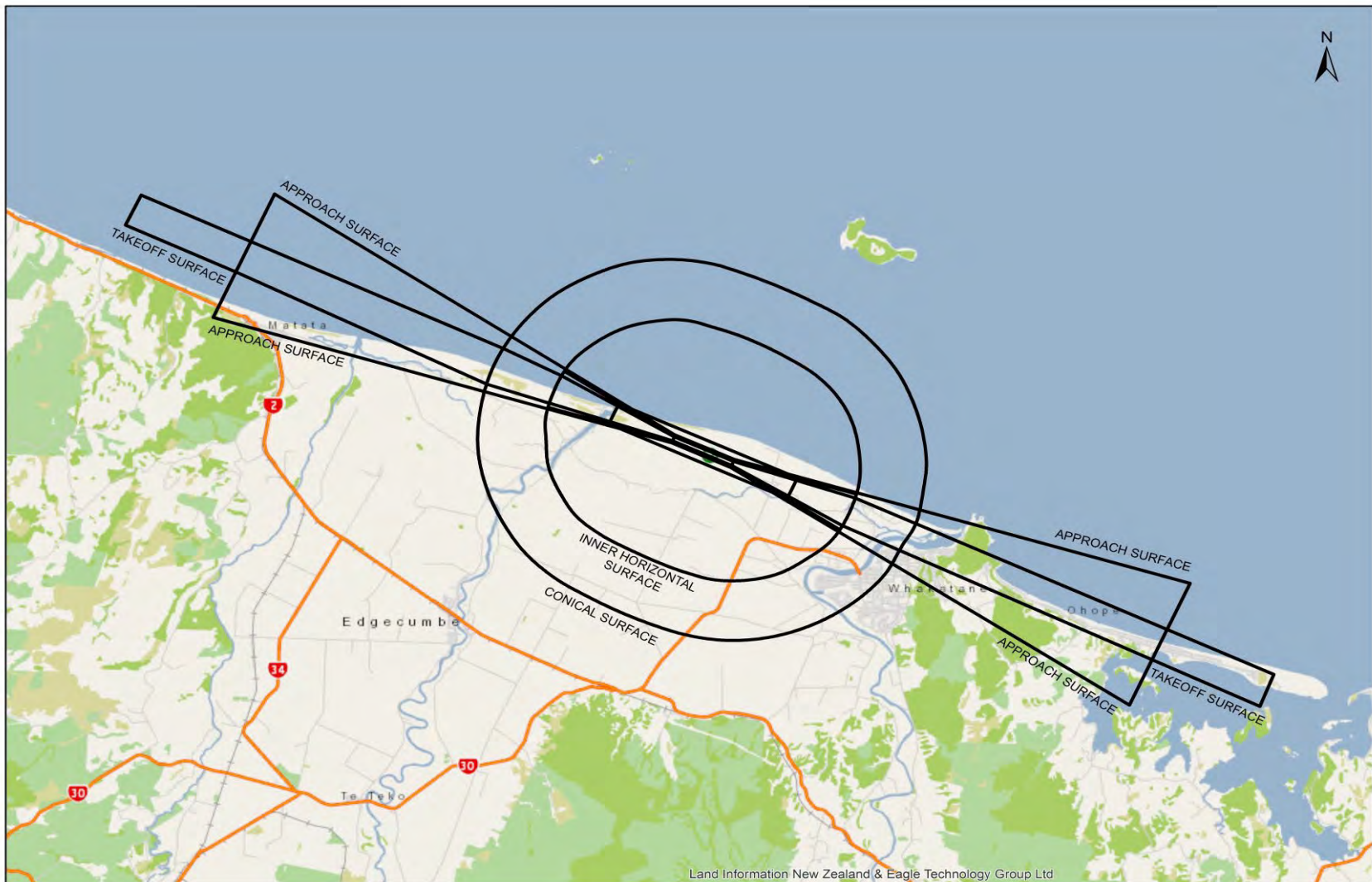

Figure 13.27 Whakatāne Airport Approach Path

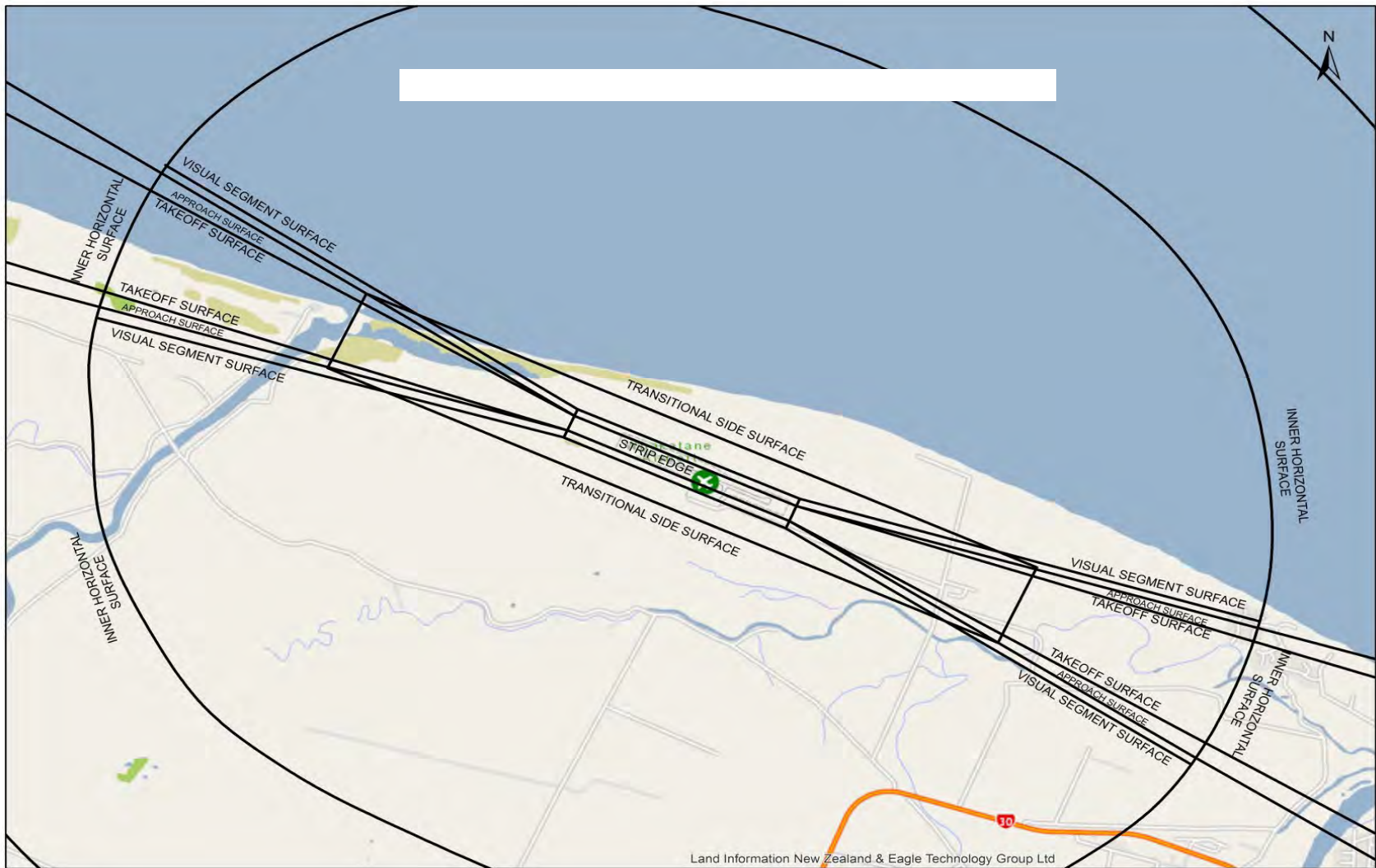

Figure 13.28 Galatea Airport Approach Path

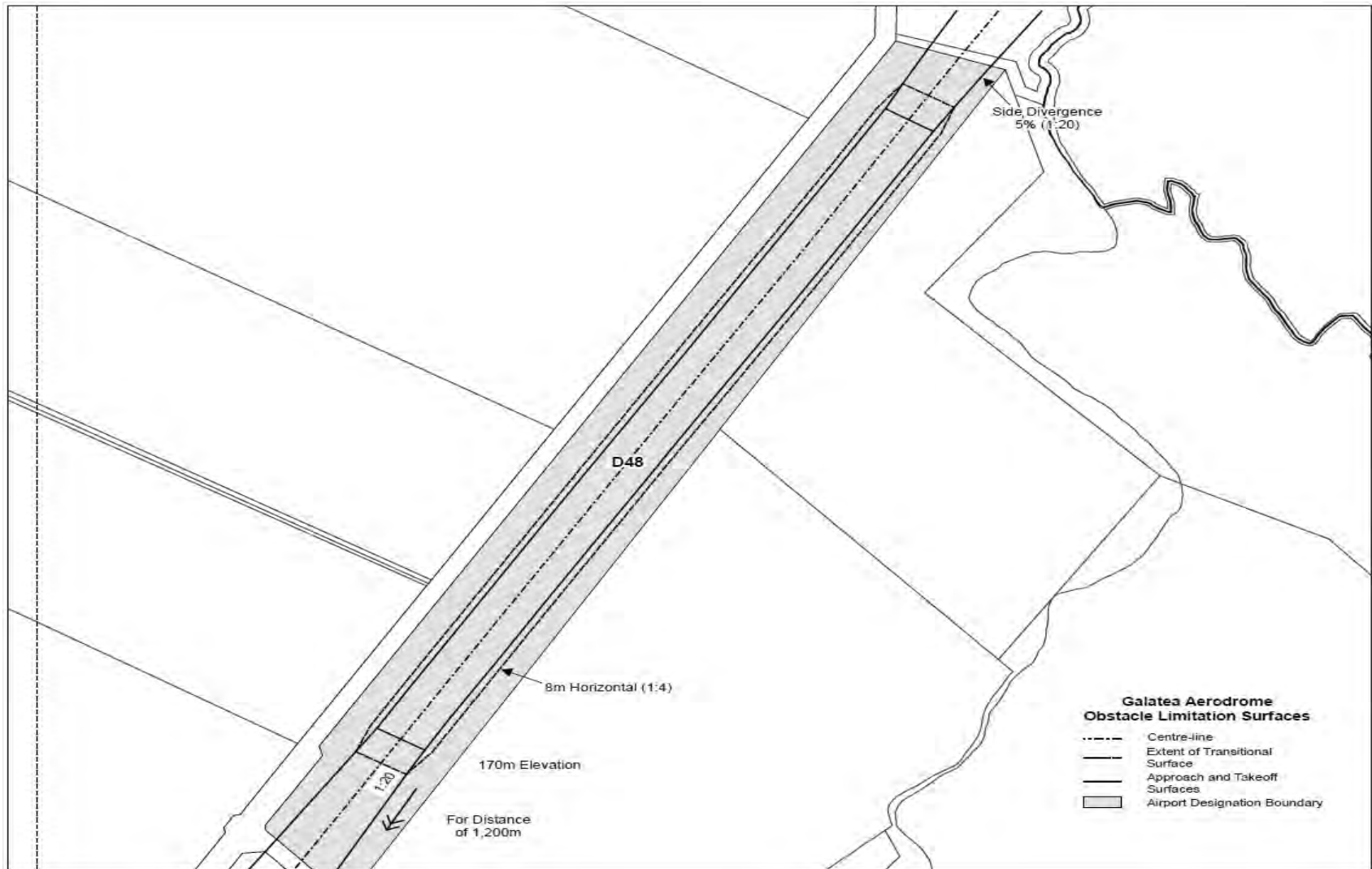

Figure 13.29 Galatea Aerodrome Obstacle Limitation Surfaces