

REPORT

Whakatane Commercial Wharf

Condition Assessment and Repair Options Report

**Prepared for:
Whakatane District Council**

February 2015
Job No: 851847



REPORT

Whakatāne District Council

Whakatāne Commercial Wharf
Condition Assessment and Repair
Options Report

Report prepared for:
WHAKATĀNE DISTRICT COUNCIL

Report prepared by:
Tonkin & Taylor Ltd

Distribution:
WHAKATĀNE DISTRICT COUNCIL
Tonkin & Taylor Ltd (FILE)

2 copies

1 copy

February 2015

T&T Ref: 851847.0000



Table of contents

1	Introduction	1
2	Background	1
3	Scope	1
4	Wharf Structure	2
5	Condition Assessment	2
5.1	Methodology	2
5.2	Results	3
5.2.1	1936 Section	3
5.2.2	1940 Section	3
5.2.3	1919 Section	3
6	Repair Options	4
6.1	General	4
6.2	Option 1 – Closure	4
6.3	Option 2 – Monitor and staged closure	4
6.4	Options 3 and 4 - Structural repairs	5
6.4.1	General	5
6.4.2	Option 3 – Short term repairs	6
6.4.3	Option 4 – Medium term repairs	6
6.4.4	Seismic considerations	7
6.5	Option 5 – Replace existing wharf	8
7	Repair costs	9
8	Conclusions	10
9	Applicability	12

Appendix A: Photographs

Appendix B: Drawings (from 2009 Opus Report)

Appendix C: Schedule of Repair Costs

Appendix D: Seismic – Initial Evaluation Procedure

1 Introduction

Whakatāne District Council (WDC) commissioned Tonkin & Taylor Ltd (T&T) to undertake a structural condition assessment on the concrete structural elements of the Whakatāne Commercial Wharf and prepare options and cost estimates for repair works. This report summarises the findings of this assessment.

2 Background

In 2009 WDC commissioned Opus to undertake an inspection of the Whakatāne Commercial Wharf and prepare a report regarding its condition, structural capacity and future repair options. Regarding the condition of the structure, the Opus report¹ concluded that:

'All sections of the wharf are showing signs of significant corrosion of reinforcing steel, spalling and other evidence of corrosion.'

Based on the condition of the structure in 2009, and assumed material properties, Opus carried out a structural analysis of the deck slab, beams and piles using section 6.5.3 of the Transit NZ Bridge Manual. Opus concluded that:

'Calculations show that the limiting member to carry the above loads are the deck slabs, as these are likely to fail primarily in flexure due to sagging moments...The calculations show that the wharf should be weight restricted to vehicles having an axle limit of 2,000kg for safety reasons.'

Regarding options for repair, Opus concluded that:

'The ingress of chlorides into the structure means that repairs will be a costly exercise. Full replacement is considered to be the only long term economic option. Given the life of the structure it is recommended that Council adopt a policy of monitoring until incipient failure (i.e. sagging deck or holes in the deck) requires replacement. Staged replacement of the sections can be undertaken over a 20 year period as funding permits.'

3 Scope

The scope of our assessment, as per our proposal of June 2014 and clarification letter of 20 August 2014, was as follows:

- Visual condition assessment of the wharf (1919, 1936 and 1940 sections) at low tide, and comparison of the wharf condition with the 2009 Opus report;
- Consideration of repair options, including:
 - Whether repairs could be deferred until 2017;
 - Whether short term repairs (e.g. to extend the life of the structure by 5 to 10 years) may be appropriate;
- Cost estimates for both short term (if appropriate) and long term repair options.

¹ Opus International Consultants Ltd, 5 August 2009. Whakatane Wharf Structural Assessment Report. Reference 288081.04, Report # 09/023

The scope was extended to undertake an Initial Evaluation Procedure (IEP) to assess whether the wharves would be classified as Potentially Earthquake Prone Buildings and to consider the potential impact on the repair options.

4 Wharf Structure

The Whakatāne Commercial Wharf is located on the right bank of the Whakatāne River, some 900 m upstream of the river mouth.

The wharf is a piled reinforced concrete structure, consisting of three separate sections. The upstream section was constructed in 1919 and has a berth length of around 40 m. The downstream section was constructed in 1936 and has a berth length of around 30 m long. The intermediate section between the upstream and downstream sections was constructed in 1940 and has a berth length of approximately 70 m.

The structural form of each section is similar, consisting of a grid of square reinforced concrete piles linked by longitudinal and transverse reinforced concrete beams. In addition to these main beams, there are smaller intermediate beams at 1.2 m spacing which span from front to back. The beams support a cast *in situ* reinforced concrete deck slab. Site measurements indicate that the deck slab is typically in the order of 190 mm – 200 mm thick. Each pile bent is laterally braced by a diagonal reinforced concrete raking beam.

The 1936 and 1940 sections of the wharf are approximately 7.5 m wide and are supported by three rows of piles. The 1919 section (at the western end of the wharf) is approximately 11 m wide and is supported by four rows of piles.

Buildings are located directly behind (to the south) of the 1940 section of wharf, and partially above the 1919 section of wharf.

Signage is present on the wharf restricting axle loading to 2000 kg, as recommended in the 2009 Opus report (refer section 2 above).

A light and webcam pole, approximately 8 m high, is present at the eastern end of the wharf. This pole was referred to in the Opus report. Since the 2009 report, an additional similar pole has been fixed to the seaward edge of the wharf at the western end of the 1940 section. The Opus report also noted the presence of a light pole fixed to the landward edge of the 1940 wharf. This pole has since been removed.

5 Condition Assessment

5.1 Methodology

A visual inspection was undertaken on all three sections of the wharf on 5 November 2014.

Our condition assessment consisted of a visual and photographic survey of the deck top surface and underside of the wharf, conducted at low tide. The accessible parts of the piles, beams and underside of the slab were tested using a hammer to identify hollow, drummy or loose areas of concrete. A limited visual inspection of the front face of the wharf was also carried out from the available access ladders.

Defects such as cracking and spalling that have occurred since the Opus 2009 report were recorded on a copy of the Opus drawings (refer Appendix B). This allows a comparison to be made between the 2009 condition and current condition, and illustrates the rate of deterioration of the structure.

Photographs of typical defects are included in Appendix A. Not all defects have been photographed due to poor light conditions below the wharf.

5.2 Results

5.2.1 1936 Section

The members of the 1936 section are extensively deteriorated, with a significant number of additional / exacerbated defects observed relative to the 2009 Opus report. Longitudinal cracking up to 20 mm wide and spalling of cover concrete was observed in the piles, beams and raking beams. A number of the cracks observed were in previous patch repairs that are failing.

Additional areas of spalling from the slab soffit were noted. Significant corrosion of the exposed reinforcement was observed in the spalled areas, with total loss of reinforcing bar cross section in some areas. In some areas the depth of spalling was severe, with daylight visible through the slab between gridlines A1 and A2. **This section of slab (between A1 and A2) is considered dangerous and we recommend that this section of slab is fenced off immediately to prevent vehicle loading.**

The top surface of the slab was generally found to be in reasonable condition, with some longitudinal (east – west) cracking noted near gridlines 2 and 3, and a number of transverse cracks noted between gridlines A1 and A2. An area of crazed cracking was also noted around gridline A5.

5.2.2 1940 Section

The members of the 1940 section are not as extensively deteriorated as the 1936 section. However, cracking and spalling of concrete is evident in most of the beams and piles, and has worsened since the 2009 survey. A number of previous patch repairs to the beams and piles are continuing to fail.

Some minor areas of spalling were noted in the underside of the slab, however this does not appear to have worsened significantly since the 2009 survey.

The top surface of the slab appeared to be in good condition. However some transverse (north-south) cracking was noted between gridlines B3 and B4.

5.2.3 1919 Section

The condition of the beams and piles in the 1919 section is similar to the 1940 section. However, spalling from the underside of the slab is more extensive than in the 1936 or 1940 sections. A number of previous patch repairs were found to be either delaminated or cracked.

The top surface of the slab contains a large number of longitudinal cracks. A number of transverse joints at approximately 1.1 m spacing were also noted, where it appears the slab has been poured in strips.

6 Repair Options

6.1 General

The wharf is in a deteriorated state, and has continued to deteriorate in the five years since the previous condition assessment.

Based on our condition assessment of the wharf, we have considered the following options for the wharf. These options are detailed in the subsections below.

1. Closure;
2. Monitor and staged closure;
3. Short term repairs;
4. Medium term repairs;
5. Replace existing wharf.

6.2 Option 1 – Closure

We have considered whether the deterioration of the wharf requires immediate closure. Based on our inspection we consider that Section A1-A2 of the wharf should be immediately closed. However, the remaining sections of the wharf still have residual capacity at current loadings to remain open. On-going monitoring of the wharf should be undertaken as detailed in Option 2 below.

6.3 Option 2 – Monitor and staged closure

We consider that sections of the wharf still have residual capacity and can continue to remain open in the short term until either repairs are undertaken, or until deterioration of the wharf reaches a condition where closure of additional sections of the wharf, and ultimately the entire wharf, is recommended.

Sections A1 – A2 should be closed immediately.

The residual life of the remaining sections of the wharf is unable to be accurately quantified. However, we have noted significant deterioration since the 2009 inspection, particularly to the soffit of the deck which indicates that additional areas can be expected to be closed within the next 1 to 2 years, and potential complete closure of the 1919 and 1935 sections within the next 5 to 10 years.

The wharf should be regularly monitored (twice annually as a minimum) by a structural engineer for additional deterioration.

A managed process should be put in place to communicate to wharf users and tenants that any notification of closure of a section of wharf will be effective immediately.

Issues that would need to be considered for this option include:

1. The stability of the building which is partly supported by the 1919 section of the wharf which is exhibiting deterioration. Immediate closure of the building may be advised following future inspections if the deterioration reaches critical levels.
2. Continued access to all of the buildings bordering the wharf would need to be considered. Currently the wharf is used to access the buildings by delivery trucks and pedestrians;
3. The safety of boat users near the wharf, in the event of partial/complete collapse of the wharf. This is not considered to be an issue in the short term, but could be relevant if the structure was allowed to severely deteriorate.

6.4 Options 3 and 4 - Structural repairs

6.4.1 General

Options 3 and 4 below incorporate structural repairs to the wharf. The methodology of repair is essentially the same for both options with the extent and timing of the repairs being the differentiator between the two.

A specific repair detail of the defects has not been prepared as part of this report. However, a typical structural repair would likely consist of the following process:

- i. The majority of the works will be undertaken below the deck level of the wharf within the intertidal zone, with a small staging area located on the top of the deck or adjoining land area. The access for repairs will only be able to be attained during the lower half of the tidal cycle each day. This will limit the working hours each day, and typically every second week there will be limited work during the middle of the day. Repair work is likely to be programmed to include two or three pile bays at a time, with all members requiring repair being completed prior to moving to the next section of wharf. The upper deck area above the area being repaired should be locally closed off during the repairs, and berthing adjacent to or near the section being repaired will also be restricted to reduce the risk of spray concrete 'drift' and subsequent damage claims from vessel owners;
- ii. The identified defect areas consisting of weak / loose / cracked concrete will be broken out using hydro demolition or pneumatic hammers. Typically, the concrete will be broken back past the depth of the reinforcing bars to remove chloride contaminated concrete surrounding the reinforcing. Construction platforms will be required to allow access to the deck and beam soffits of the seaward sections of the wharf, and these are typically suspended from the wharf structure itself. Given the level of the seabed beneath the wharf, it is conceivable that for this wharf, a contractor may choose to support its construction platform from the seabed;
- iii. The reinforcing steel should be cleaned of corrosion to bright steel. The Engineer should inspect and measure the residual cross-section of the exposed reinforcing steel. Typically, if the reinforcing has a residual cross-section of 90% of the original diameter, the bar would be considered acceptable and no additional steel would be required. However, if a greater level of corrosion to the reinforcing steel is encountered then the bar would be exposed with additional concrete breakout, until acceptable steel is encountered. Additional reinforcing steel bars will need to be spliced to the corroded steel and welded onto the acceptable steel at each end of the bars;
- iv. The exposed reinforcement and broken back concrete would be coated in a corrosion inhibiting slurry to reduce the potential of residual chlorides within the original concrete from corroding the concrete.
- v. Depending on the extent of cracking and or corrosion of reinforcing steel on the deck slabs and intermediate beams, it may be more practical to drill and epoxy fix starter bars into the beams and place new reinforcing steel or mesh on the underside of the deck;
- vi. All broken out areas should be reinstated with a marine grade concrete. Depending of the location of the repair, this would be undertaken using a sprayed concrete or if the repair area is small the Contractor may elect to locally box the repair and pour in micro (small aggregate) concrete.

6.4.2 Option 3 – Short term repairs

As noted in Option 2, the wharf still has a limited remaining life allowing options to be considered for repair or replacement of the wharf. We have considered whether a 'short term' repair can be undertaken to keep the wharf open for the next 5 to 10 years.

The main structural element limiting the capacity of the wharf at present is the spalling to the soffit of the decking. Repairs to the currently identified defect areas of the deck will extend the life of the wharf in the short term, and reduce the potential for short notice closure of sections of the wharf. Closure of sections A1-A2 should be undertaken immediately until repairs are undertaken. Repairs to the spalling to the remaining sections of decking over all three sections of wharf, plus repairs to the beams and piles beneath the building in the 1919 section, should be undertaken within the next 1 to 2 years, if the wharf is to remain open for the next 5 to 10 years.

The wharf should be inspected annually to assess for further deterioration. Areas of spalling on the underside of the deck, or deterioration to other structural elements reaching a critical level, identified in subsequent inspections should be repaired within a timeframe as recommended by the inspecting engineer at the time. At this stage it seems probable that further repairs may be required at approximately year 4 and year 8, in order to keep the wharf operational.

It is expected that full structural repairs to the structural beams and columns as detailed in Option 4 below should be undertaken within the next ten years, if the life of the wharf is to be extended beyond this period. Delays to repairing these structural elements in the intervening years will likely result in additional deterioration and a higher cost of medium term repairs detailed in Option 4, and higher overall costs.

6.4.3 Option 4 – Medium term repairs

This option involves undertaking structural repairs to all the identified defects in the concrete beams, piles and slab elements.

Given the existing level of deterioration, it is unlikely that all chloride contaminated concrete could be removed from the structure. Therefore, deterioration of the repaired areas may continue, albeit at a slower rate. If well executed, this form of repair is likely to last in the order of 15 to 20 years, although this will depend on the degree of contamination in the remaining concrete.

It should be noted that these repairs will not prevent further deterioration of unrepaired sections of the wharf. Further deterioration of unrepaired areas, including areas which do not currently exhibit any signs of deterioration, can be expected due to chloride ingress into the old concrete which in turn will corrode the old reinforcing steel. Repairs to these other areas are likely to be required within the next 10 to 15 years.

We recommend that a waterproofing membrane is applied to all concrete piles, beams and the underside of the concrete decking to reduce the potential for future oxygen and chloride penetration into the concrete, which is the mechanism for the corrosion of the reinforcing steel. Some waterproofing membranes come with a supplier guarantee of 10 years and if applied we would expect that deterioration of unrepaired areas may be reduced over this ten year period. We would also expect that the repaired areas would then last between 20 to 30 years, before further deterioration becomes evident.

6.4.3.1 Repair schedule

A schedule of repairs is presented in Appendix C. In the schedule we have prioritised the repairs into three categories:

Immediate Priority: This relates to the section of slab at the rear of the wharf between gridlines A1 and A2. **This section of slab is considered dangerous and we recommend that this section of wharf deck is fenced off immediately to prevent vehicle loading until repairs are completed.**

High Priority: This relates to the longitudinal and transverse beams, slab and piles for all sections of the wharf, plus the raking beams of the 1919 section (which are included as the 1919 section is partially supporting the building above). It is recommended that these repairs are undertaken within the next one to two years.

Low Priority: This relates to the raking beams for the 1936 and 1940 sections of the wharf. These are considered to be a lower priority than the other elements, as the wharf is no longer used as a commercial wharf subject to large berthing and mooring forces. If limited budget is available for repairs at the same time as the High Priority repairs, then these can be undertaken within the next five to ten years.

It should be noted that undertaking these repairs would not necessarily allow the 2000 kg axle limit to be removed, unless the repairs also include a degree of wharf deck strengthening.

6.4.4 Seismic considerations

The structural options discussed above are to repair defects within discrete sections of the wharf. However, the wharves were constructed well before current seismic codes and the repairs will not increase the capacity of the wharf to sustain dynamic (i.e. seismic) loads.

All Territorial Authorities in New Zealand are required by the Building Act 2004 to have developed and implemented a policy on determining which buildings might be prone to significant damage as the result of an earthquake. The WDC has developed a policy document entitled "Earthquake-prone, dangerous and insanitary buildings policy" dated 26/8/2012. This document sets out the intended practice for the WDC with regard to earthquake-prone, dangerous and insanitary buildings including processes and timeframes for assessing and strengthening buildings.

The 1919 section of wharf has a commercial building occupying the space above the wharf structure, and the remaining section of wharf is open to the public. The wharf structure does not appear to be included within the exclusion provisions within Section 6.1.6 of the policy. Based on its current use we would expect that all three wharves would be considered Importance Level 3 (IL3) structures as they are facilities where more than 300 people can congregate in one area.

We understand that a check of the seismic performance of the wharf has not been undertaken so far by WDC. As part of the present report we have undertaken an Initial Evaluation Procedure (IEP). The IEP procedure was developed in 2006 by the New Zealand Society for Earthquake Engineering (NZSEE) and updated in 2013 to reflect experience with its application and as a result of experience in the Canterbury earthquakes. It is a tool to assign a percentage of New Building Standard (%NBS) score and associated grade to a building as part of an initial seismic assessment of existing buildings. The process and the associated %NBS and grade should be considered as only indicative of the building's compliance with current code requirements. The assessment assumed that the wharf has been repaired to reinstate spalled / cracked concrete and replace corroded reinforcing bars. The results of this assessment is presented below:

Table 6-1 NZSEE Initial Evaluation Procedure

Wharf section	Percentage New Building Standard (%NBS)	Seismic Grade
1919	10	E
1936	15	E
1940	15	E

The assessment indicates that the wharf has a seismic capacity well below the minimum level for strengthening of 33% New Building Standard (%NBS) and significantly below the WDC preferred level of 67% NBS, and are considered Potentially Earthquake Prone Buildings.

Based on Table 4 of the WDC policy, the structure would be classified as a High Priority and the maximum timeframe for strengthening is 10 years.

A methodology for a seismic upgrade to the wharf is not included as part of this assessment. Further studies would need to be undertaken to assess the options and associated costs of a seismic upgrade of the wharves.

6.5 Option 5 – Replace existing wharf

This option involves demolition and replacement of all three sections of the wharf. If the wharf demolition and replacement is undertaken in stages, the remaining wharves should be subject to regular (twice annually) inspections by an experienced engineer to monitor their condition.

This option was discussed and costed in the 2009 Opus report. The 2009 costing has not been updated for this report.

7 Repair costs

A high level construction cost estimate based on current estimated rates (exclusive of GST), and based on our mapping of the existing identified defects has been prepared for Option 3 (Short term) and Option 4 (Medium term) repairs.

Table 7-1 Summary of repair costs

Option	Year 1-2	Year 3-5	Year 6-9
Option 3 (Short term)	Deck soffit repairs plus repairs under building \$220,000 to \$280,000	Localised deck soffit, beam and column repairs \$120,000 to \$150,000 ¹	Localised deck soffit, beam and column repairs \$120,000 to \$150,000 ^{1,2}
Option 4 (Medium Term) ³	\$1,000,000 to \$1,400,000	-	-
<p>1. Assumes additional repairs are undertaken following identification of additional elements requiring repairs during annual inspections. Estimate based on additional defects identified between 2009 and 2014.</p> <p>2. Assumes Option 4 Medium term repairs are undertaken in year 10 following the short term repairs.</p> <p>3. Repairs to existing identified damage only. Additional repair costs may be incurred in subsequent years due to corrosion of reinforcing steel within the 'un-repaired' sections. The costs exclude seismic upgrade.</p>			

The Medium term repair option cost estimate includes repairs to presently identified defects plus applying a waterproofing membrane. If the low priority items (i.e. raking beams in the 1936 and 1940 sections) were not repaired at this stage, we would expect the costs to reduce by about \$150,000 in the first year.

A separate consideration is the requirement for a seismic upgrade. Further studies are required to develop options and prepare a cost estimate for a seismic upgrade. However, it would be reasonable to assume that the costs will be significantly higher than the medium term repair option alone.

This construction cost estimate above is based on an estimated volume of concrete required to repair the wharf based on our inspections. The cost of structural repair options has uncertainties as the extent of corrosion of the reinforcing steel beneath the existing repairs is unable to be determined until the concrete is broken out. In addition the extent of breakout can also increase significantly once the repair works commence. Accordingly, the cost estimates includes a contingency of 50%.

We note that repairs can be staged to suit budget constraints, however, as mobilisation costs are likely to be a significant component of cost, splitting the repairs into several contracts will likely result in higher costs.

Costs associated with design, supervision and any consenting requirements are excluded from the above repair cost estimates.

8 Conclusions

The Whakatāne Commercial Wharf has undergone additional deterioration since the last reported inspection undertaken by Opus in 2009. The additional deterioration includes increased cracking and spalling of concrete beams, piles and slabs under the wharf, indicating further corrosion of reinforcing steel due to chloride ingress has occurred.

Of immediate concern is the wharf slab at the south eastern corner of the 1936 wharf (between gridlines A1 and A2 and gridlines 2 and 3), where the reinforcement has completely corroded in places and daylight is visible through the slab. **This section of slab is considered dangerous and we recommend that this section of slab is fenced off immediately to prevent vehicle loading.**

Of the remaining sections, we consider that overall the wharf has a relatively short remaining life without repair, in the order of 5 to 10 years.

We have considered five options for the future of the wharf. The options considered were:

1. Closure;
2. Monitor and staged closure;
3. Short term repairs;
4. Medium term repairs;
5. Replace existing wharf.

Of these five, four appear to be valid management options which will allow further use of the wharves. These are:

- Option 2 – Monitor and staged closure. Immediate closure of sections of the wharf may be recommended by the inspecting engineer;
- Option 3 – Short term repairs to the soffit of the deck, plus to the piles and beams under the building in the 1919 section of wharf, which has an initial construction cost estimate of \$220,000 to \$280,000, plus monitoring and on-going repairs to deteriorating sections of the wharf in subsequent years. This is expected to extend the life for a short period to enable decisions on the future of the wharf to be made. Additional repairs of a similar order of costs would be expected to be required in years 4 to 5, and years 8 to 9, in order to extend the wharf life to 10 years;
- Option 4 – Medium term repairs which have a construction cost estimate of between \$1,000,000 and \$1,400,000 and should be undertaken within the next 2 years, with acceptance that some areas of the wharf may need to be closed in the interim. The serviceable life of the wharf could be extended to between 20 to 30 years with these repairs taking place in the near future (i.e. within the next 2 years). Further repairs are also likely to be required to the unrepaired sections within the next 15 years to get the wharf to the 20 to 30 year additional life. Note the estimated costs do not include any costs for seismically upgrading the wharf, to meet Councils policy regarding earthquake prone buildings, as this requires a separate more detailed assessment; and
- Option 5 – Replacement with a new wharf.

An initial evaluation assessment indicates that the seismic capacity of all the wharves are significantly below the minimum 33% of New Building Standard required for seismic strengthening. The wharves are considered Potentially Earthquake Prone Buildings under the Building Act 2004. Based on the WDC document entitled "Earthquake-prone, dangerous and insanitary buildings policy", the wharves would be classified as a High Priority with a maximum timeframe for assessment and strengthening of 10 years assuming an Importance Level 3 building. Further investigations will be required to assess options and costs for a seismic upgrade. This should be undertaken before decisions are made regarding the short and medium term

structural repair options discussed within this report. It may be that when costs for seismically upgrading the structures are assessed, that the most cost effective long term strategy is to plan for staged replacement of the wharves with new structures.

9 Applicability

This report has been prepared for the benefit of Whakatāne District Council with respect to the particular brief given to us and it may not be relied upon in other contexts or for any other purpose without our prior review and agreement.

Tonkin & Taylor Ltd

Environmental and Engineering Consultants

Report prepared by:

Authorised for Tonkin & Taylor Ltd by:

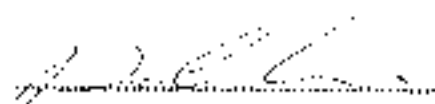

Dale Vince

Structural Engineer

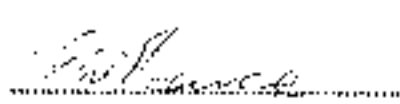

Grant Pearce

Project Director



Lance Partner

Project Manager

DRV

P:\051847\Issued Documents\20150710 Final\20150210 Whakatane Town Wharf Assessment report.docx

Appendix A: Photographs

Appendix A - Site Visit Photos 05 November 2014



Photo T01 - view from east end of wharf



Photo T02 - pole at east end of wharf

Appendix A - Site Visit Photos 05 November 2014



Photo T03 - cracking in slab (1936 section)



Photo T04 - cracking in slab (1936 section)

Appendix A - Site Visit Photos 05 November 2014



Photo T05 - cracking in slab (1940 section)



Photo T06 - cracking in slab (1940 section)

Appendix A - Site Visit Photos 05 November 2014



Photo T07 - view to east

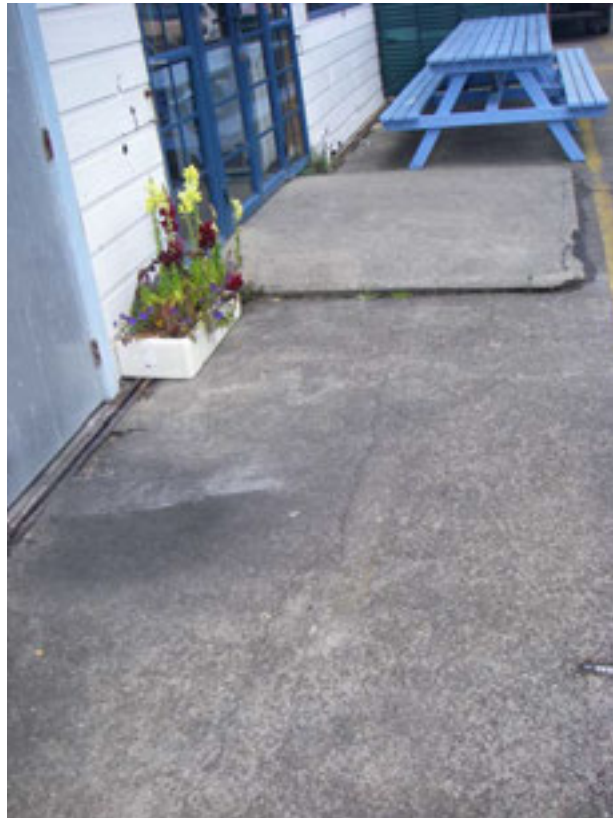

Photo T08 - cracking in slab (1919 section)

Appendix A - Site Visit Photos 05 November 2014



Photo T09 - cracking in slab (1919 section)



Photo T10 - cracking in slab (1919 section)

Appendix A - Site Visit Photos 05 November 2014



Photo T11 - cracking in slab (1919 section)



Photo T12 - cracking in slab (1919 section)

Appendix A - Site Visit Photos 05 November 2014



Photo T13 - pole on wharf (1940 section)



Photo A01 - gridline A1

Appendix A - Site Visit Photos 05 November 2014



Photo A02 - gridline A1



Photo A03 - beam cracking between A1 and A2

Appendix A - Site Visit Photos 05 November 2014



Photo A04 - slab spalling between A1 and A2



Photo A05 - slab spalling between A1 and A2

Appendix A - Site Visit Photos 05 November 2014



Photo A06 - slab spalling between A1 and A2



Photo A07 - beam cracking / spalling between A1 and A2

Appendix A - Site Visit Photos 05 November 2014



Photo A08 - beam cracking / spalling between A1 and A2



Photo A09 - View along wharf from gridline A2

Appendix A - Site Visit Photos 05 November 2014



Photo A10 - spalling of raker beam at A2



Photo A11 - spalling of raker beam at A2

Appendix A - Site Visit Photos 05 November 2014



Photo A12 - spalling / corrosion at A2



Photo A13 - spalling of slab between A2 and A3

Appendix A - Site Visit Photos 05 November 2014



Photo A14 - spalling of slab between A2 and A3



Photo A15 - cracking of beam between A2 and A3

Appendix A - Site Visit Photos 05 November 2014



Photo A16 - cracking of beam between A2 and A3



Photo A17 - spalling of beam at A3

Appendix A - Site Visit Photos 05 November 2014



Photo A18 - Pile cracking at A3



Photo A19 - Cracking of beam between A3 and A4

Appendix A - Site Visit Photos 05 November 2014



Photo A20 - spalling of beam between A3 and A4



Photo A21 - spalling of beam between A3 and A4

Appendix A - Site Visit Photos 05 November 2014



Photo A22 - spalling of beam at A4



Photo A23 - spalling of beam at A4

Appendix A - Site Visit Photos 05 November 2014



Photo A24 - spalling of beam at A4



Photo A25 - Pile cracking at A4

Appendix A - Site Visit Photos 05 November 2014



Photo A26 - cracking of raker beam at A4



Photo A27 - Cracking of pile at A4

Appendix A - Site Visit Photos 05 November 2014



Photo A28 - Cracking at A5



Photo A29 - Cracking of beam at A5

Appendix A - Site Visit Photos 05 November 2014



Photo A30 - cracking of beam between A5 and A6



Photo A31 - spalling of beam between A5 and A6

Appendix A - Site Visit Photos 05 November 2014



Photo A32 - cracking of raker beam at A6



Photo A33 - cracking of raker beam at A6

Appendix A - Site Visit Photos 05 November 2014



Photo A34 - spalling of raker beam at A6



Photo A35 - Spalling of beam between A6 and A7

Appendix A - Site Visit Photos 05 November 2014



Photo A36 - cracking of beam between A6 and A7



Photo B01- Staining at B1

Appendix A - Site Visit Photos 05 November 2014



Photo B02 - Staining at B1



Photo B03 - slab spalling between B1 and B2

Appendix A - Site Visit Photos 05 November 2014



Photo B04 - slab spalling between B1 and B2



Photo B05 - rear beam spalling between B2 and B3

Appendix A - Site Visit Photos 05 November 2014



Photo B06 - beam spalling between B4 and B5



Photo B07 - Pile cracking at B5

Appendix A - Site Visit Photos 05 November 2014



Photo B08 - Cracking of raker beam at B6



Photo B09 - spalling of rear beam between B6 and B7

Appendix A - Site Visit Photos 05 November 2014



Photo B10 - cracking of raker beam at B9



Photo B11 - spalling of raker beam at B11

Appendix A - Site Visit Photos 05 November 2014



Photo B12 - spalling of raker beam at B12



Photo B13 - spalling of raker beam at B12

Appendix A - Site Visit Photos 05 November 2014



Photo B14 - spalling of raker beam at B13



Photo B15 - spalling of raker beam at B13

Appendix A - Site Visit Photos 05 November 2014



Photo B16 - spalling of rear beam between B15 and B16



Photo B17 - cracking of rear beam between B15 and B16

Appendix A - Site Visit Photos 05 November 2014



Photo B18 - cracks in beams at B15



Photo C01 - cracking in beam at C2

Appendix A - Site Visit Photos 05 November 2014



Photo C02 - slab spalling between C2 and C3



Photo C03 - beam spalling between C1 and C2

Appendix A - Site Visit Photos 05 November 2014



Photo C04 - cracking of pile repair



Photo C05 - cracking of beam

Appendix A - Site Visit Photos 05 November 2014



Photo C06 - spalling of slab



Photo C07 - cracking of raker at C7

Appendix A - Site Visit Photos 05 November 2014



Photo C08 - cracking of raker at C6



Photo C09 - spalling of beam

Appendix B: Drawings (from 2009 Opus Report)

Note: Hand markups (in blue) showing additional defects noted in T&T's inspection of November 2014

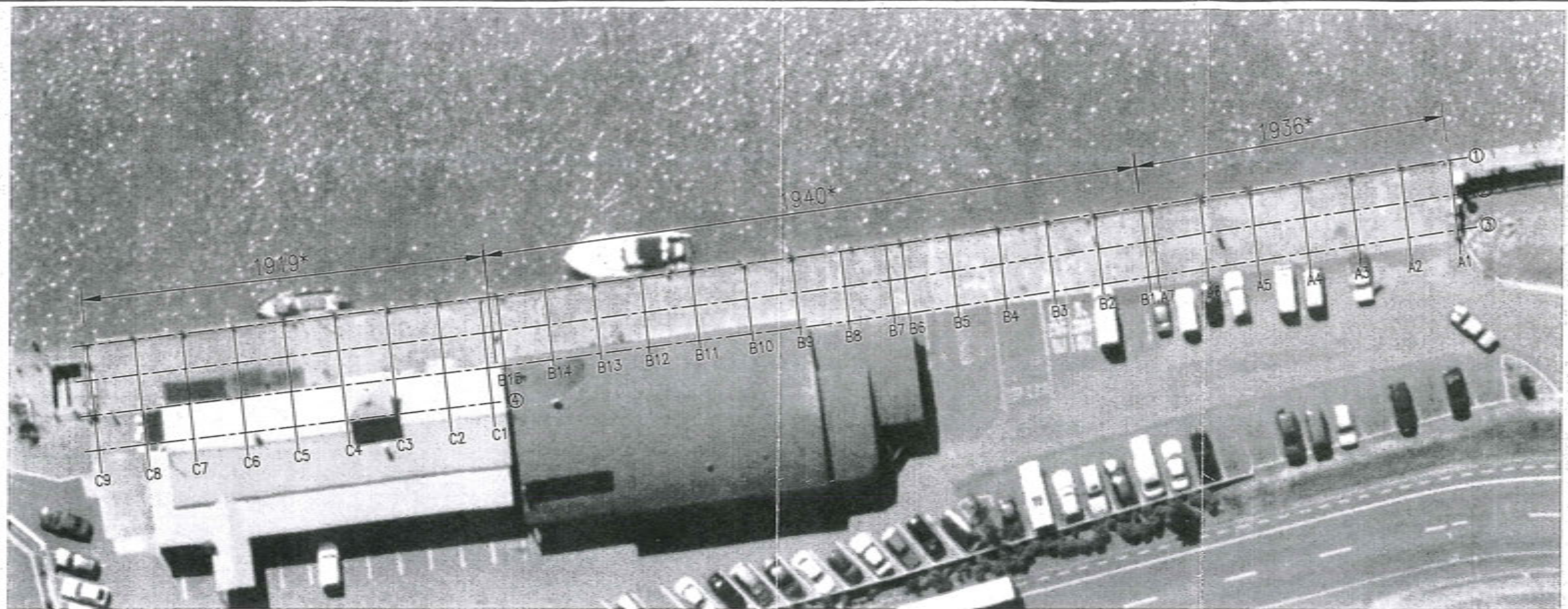

PLAN
N.T.S

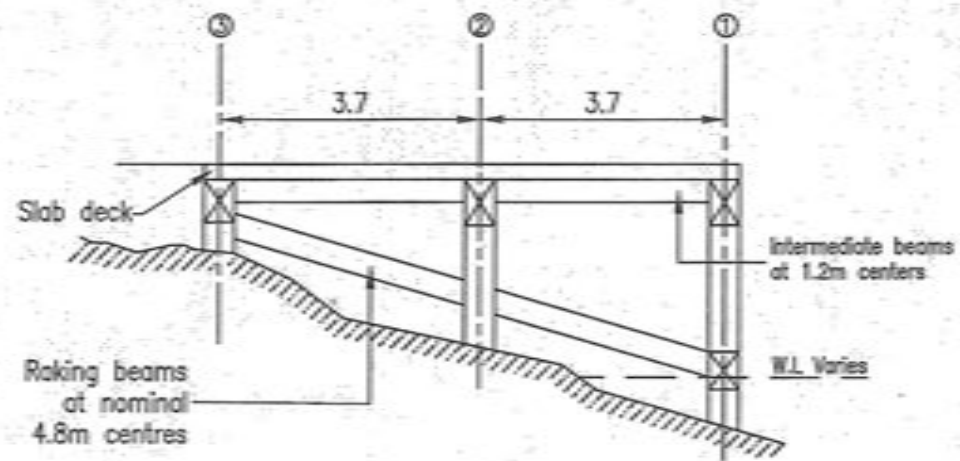

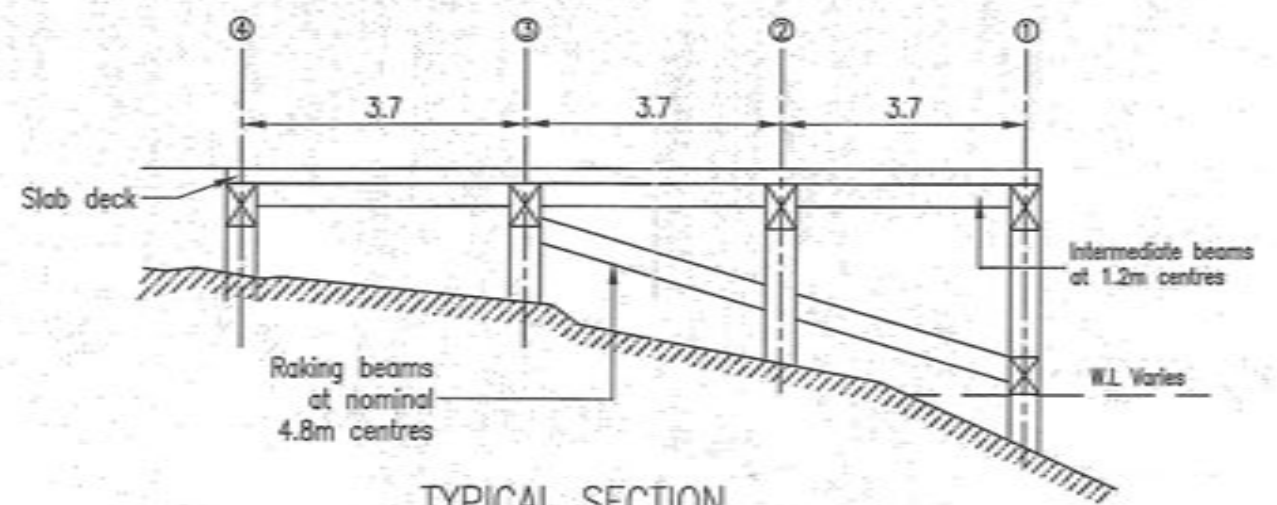

TYPICAL SECTION
1936 to 1940
Scale 1:100



TYPICAL SECTION
1940 to 1919
Scale 1:100

* Indicates year constructed

		Whakantane District Council Wharf Repairs		SCALE	TITLE 288081.04	DESIGNER
		Existing Plan and Typical Sections		ISSUE DATE 29 March 2007 © Opus International Consultants Limited		

300 mm
300
100
50
0 10 mm

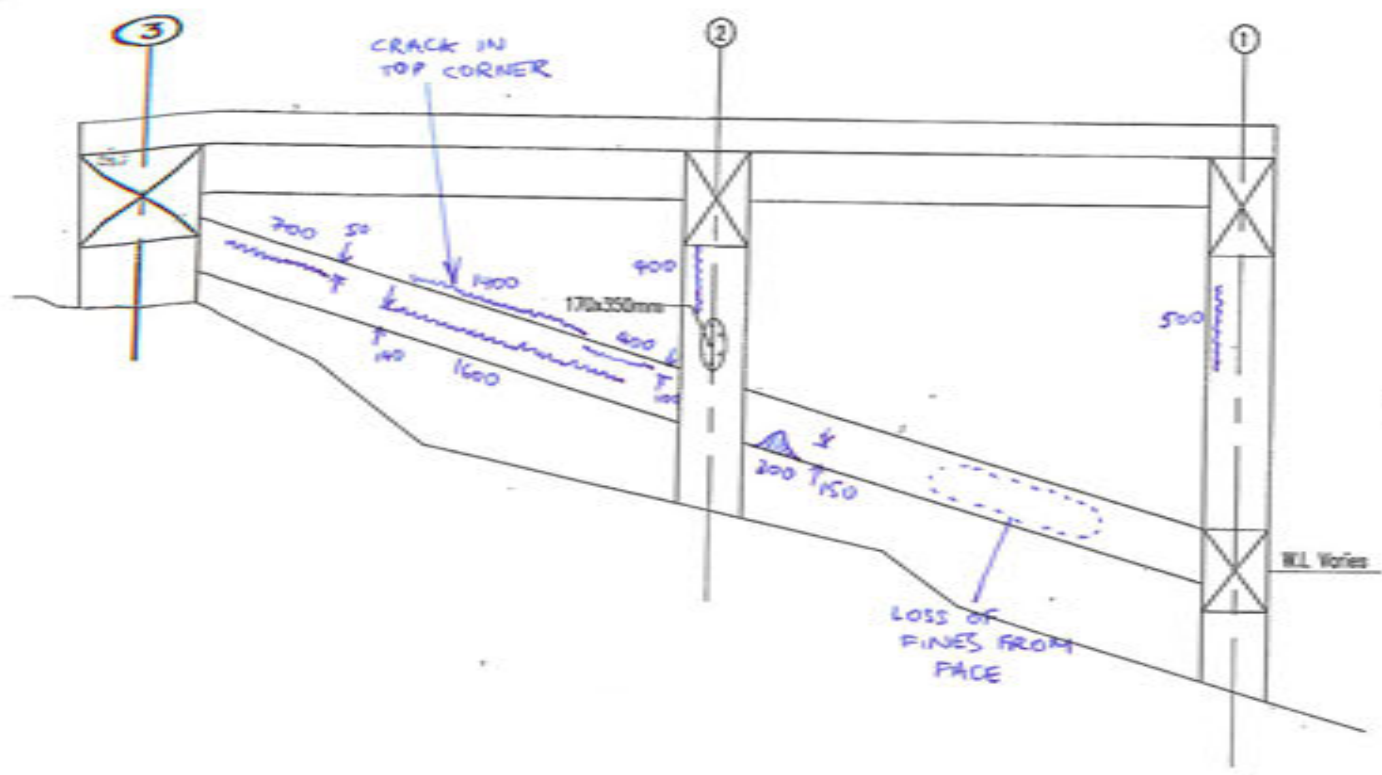

GRID ELEVATION - A1
Scale 1:25(A1)

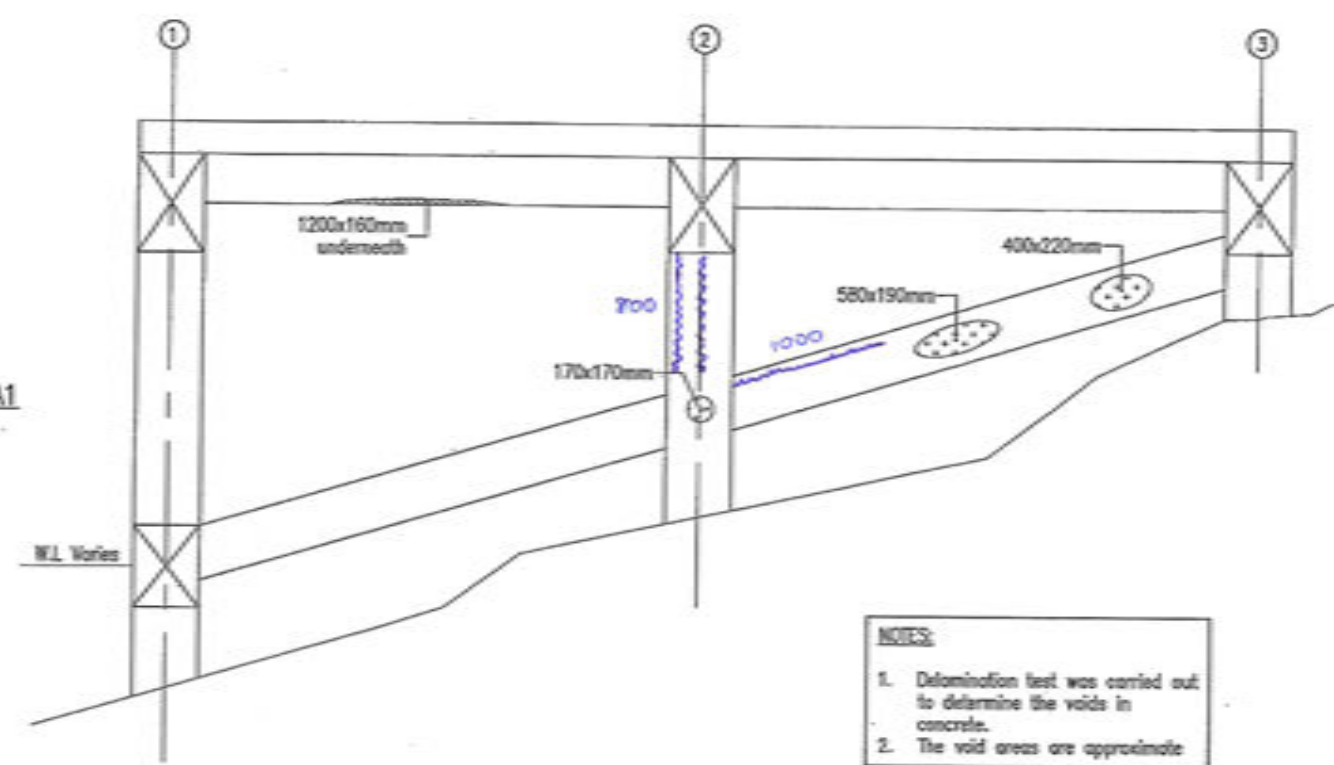

- NOTES:**
1. Delamination test was carried out to determine the voids in concrete.
 2. The void areas are approximate

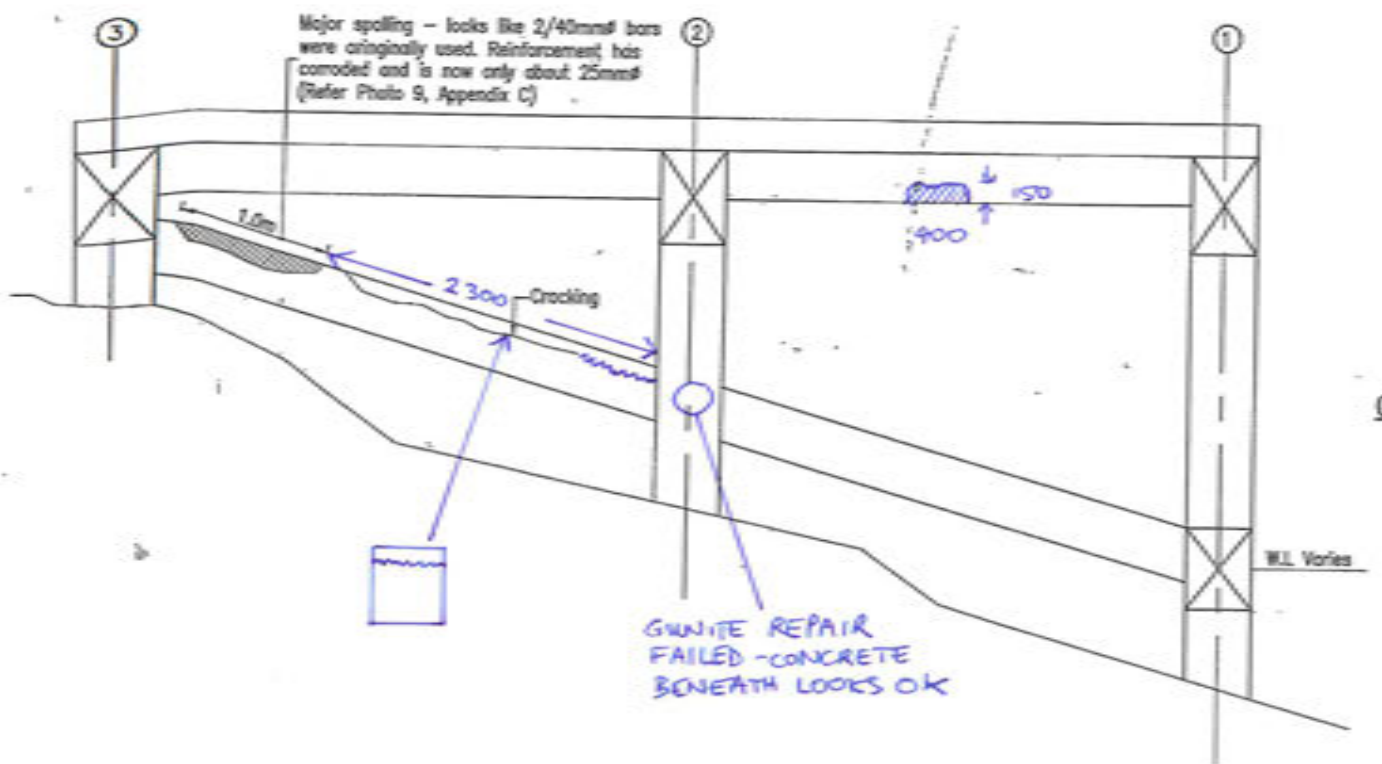

GRID ELEVATION - A2
Scale 1:25(A1)

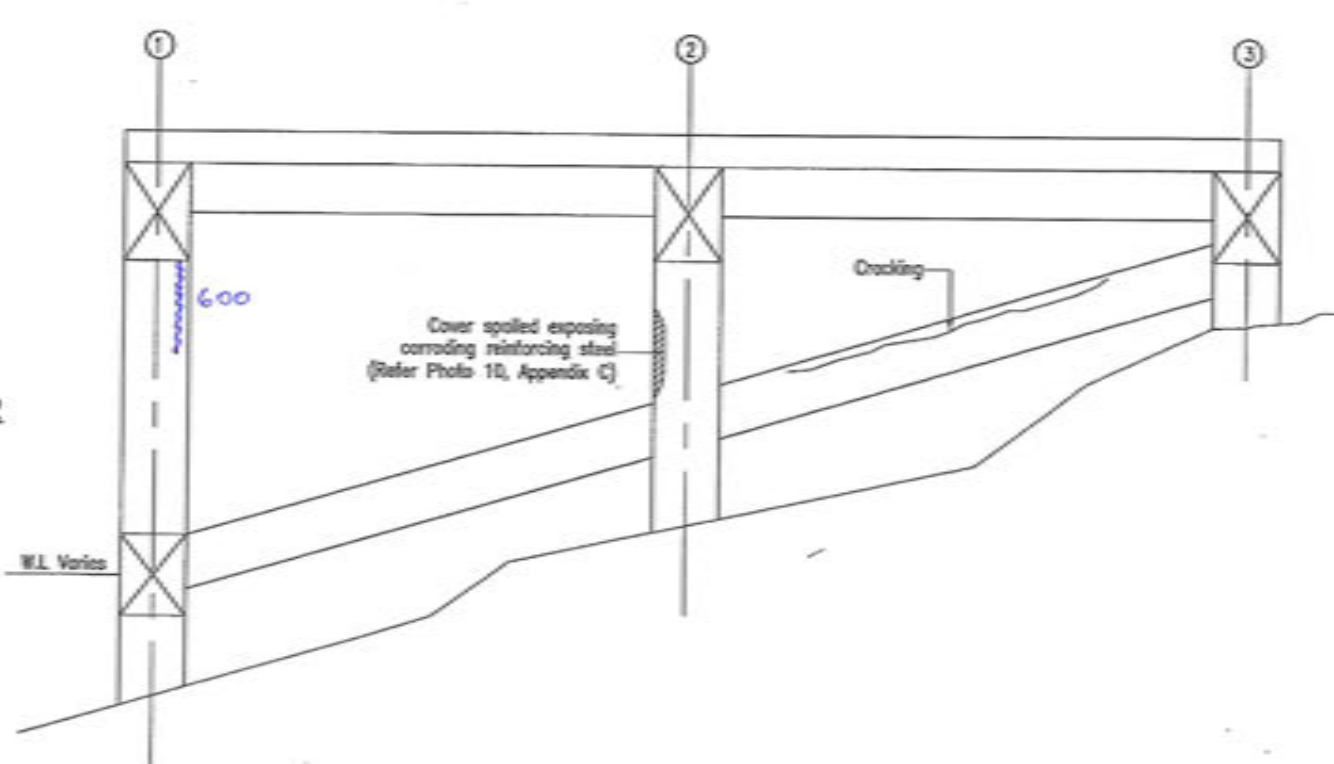

LEGEND

	Void in concrete
	Spalling of concrete
	Patch repair failure

NO.	REVISION	BY	CHECKED	DATE

DESIGN: N.P./js
DRAWN: S.Rip
DATE: March 08

APPROVED: [Signature]

This drawing and its contents are the property of Opus International Consultants Limited. Any unauthorised employment or reproduction, in full or in part, is forbidden.



Hamilton Office

Printed by 207
Hamilton, New Zealand

OPUS

Tel: +64 7 838 8344
Fax: +64 7 838 8329

PROJECT: WHAKATANE DISTRICT COUNCIL WHAKATANE WHARF - INSPECTION WHAKATANE		DRAWING NO: 288081.04	
SECTION: 1936 SECTION GRID ELEVATIONS A1-A2		DATE: 14/03/08 @ 10:42	SCALE: AS SHOWN
DATE: 14/03/08 @ 10:42	PROJECT NO: 2/214/177	CODE: 2204	SHEET: 1
REVISION: 1	REASON: RD		

30/03/2008 13:01

300 mm
200
100
0 10 mm

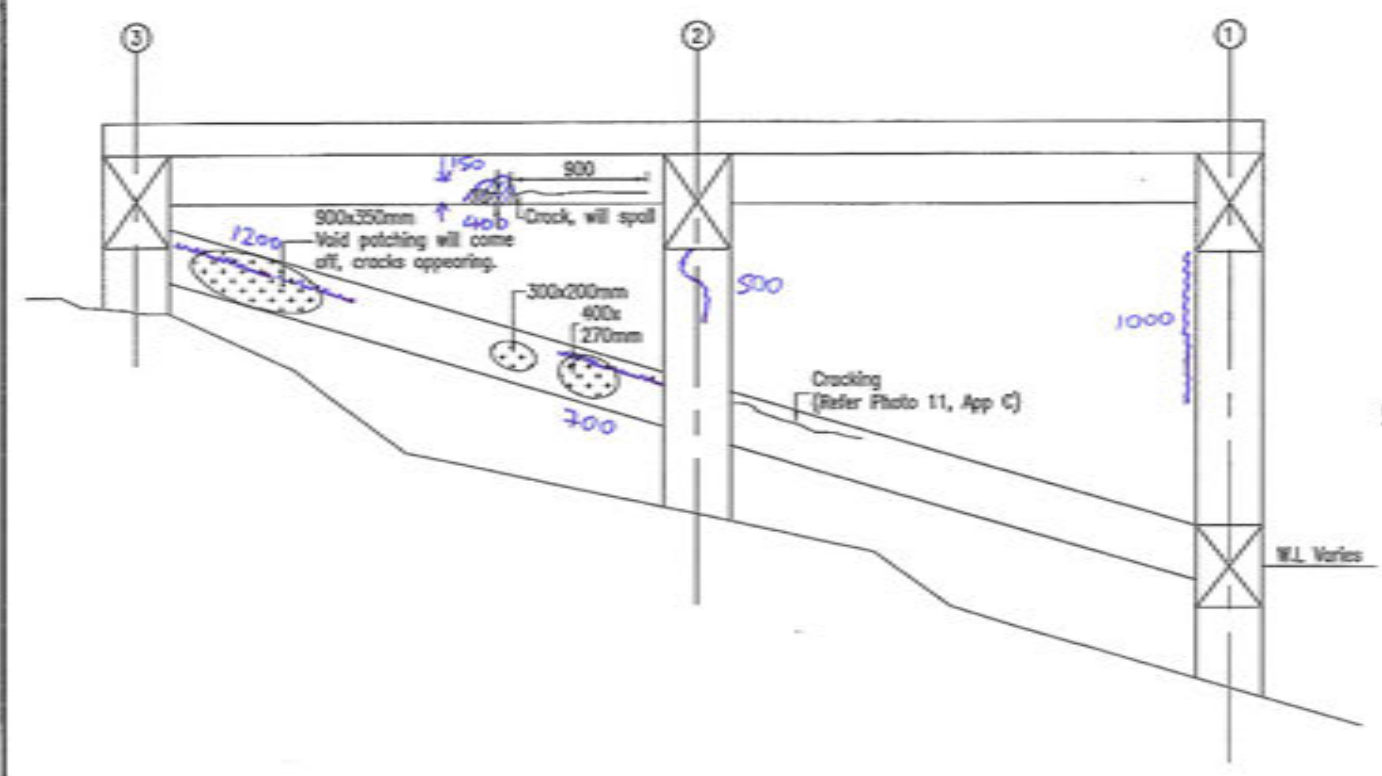

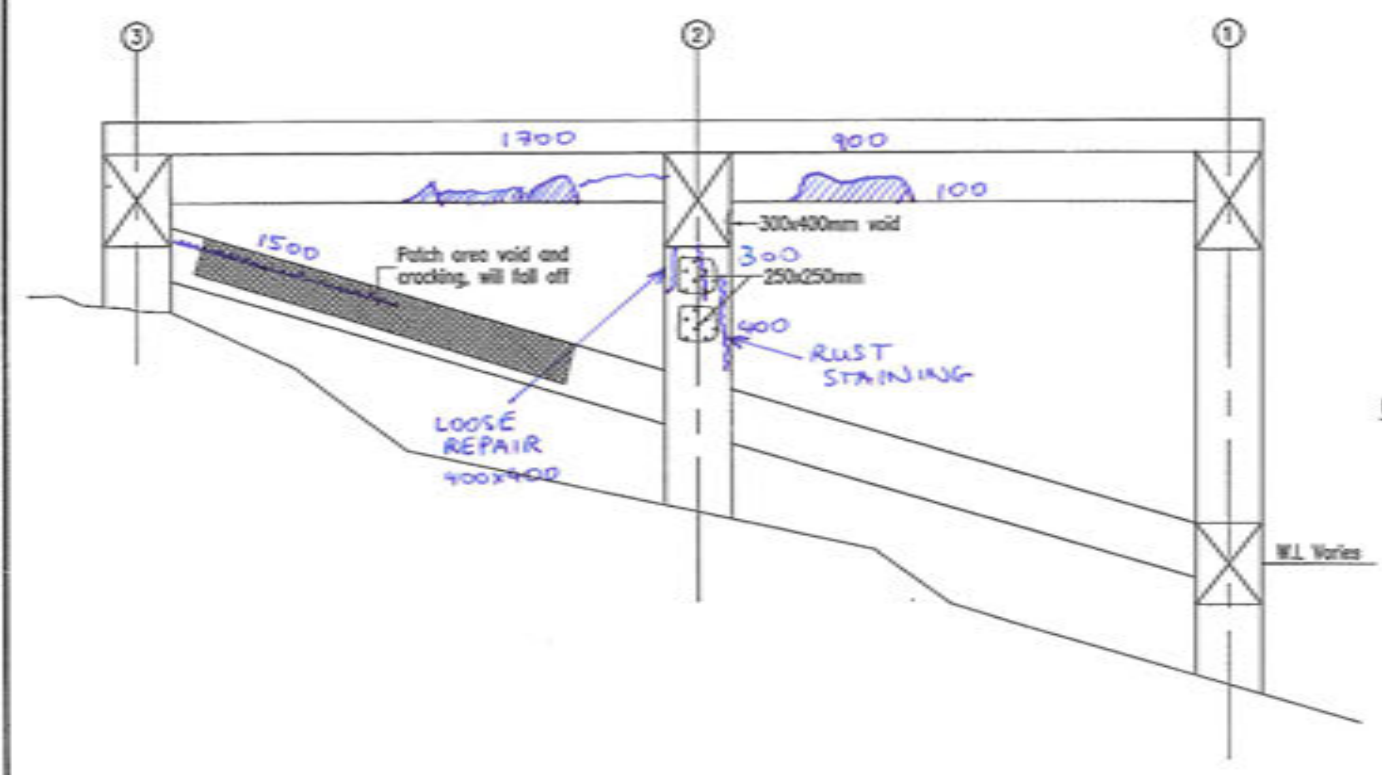
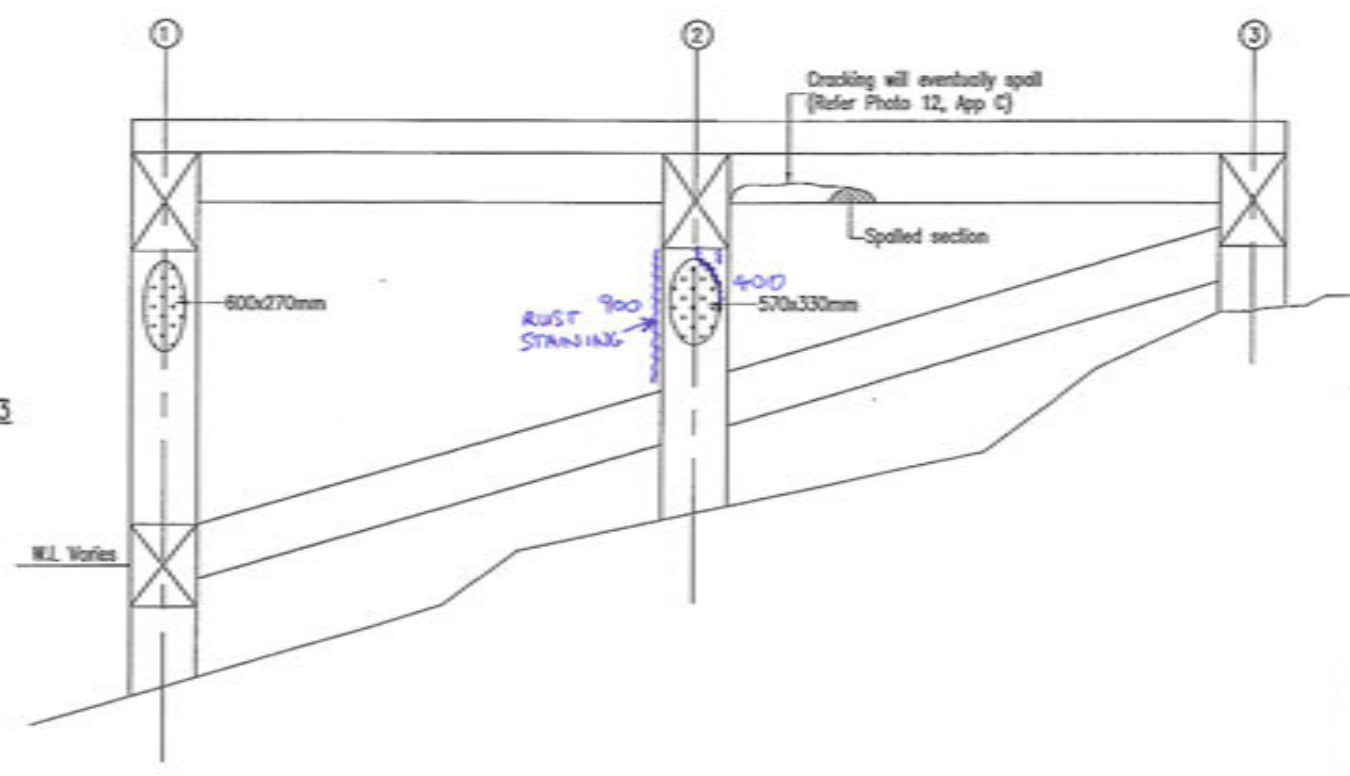

GRID ELEVATION - A3
Scale 1:25(A1)

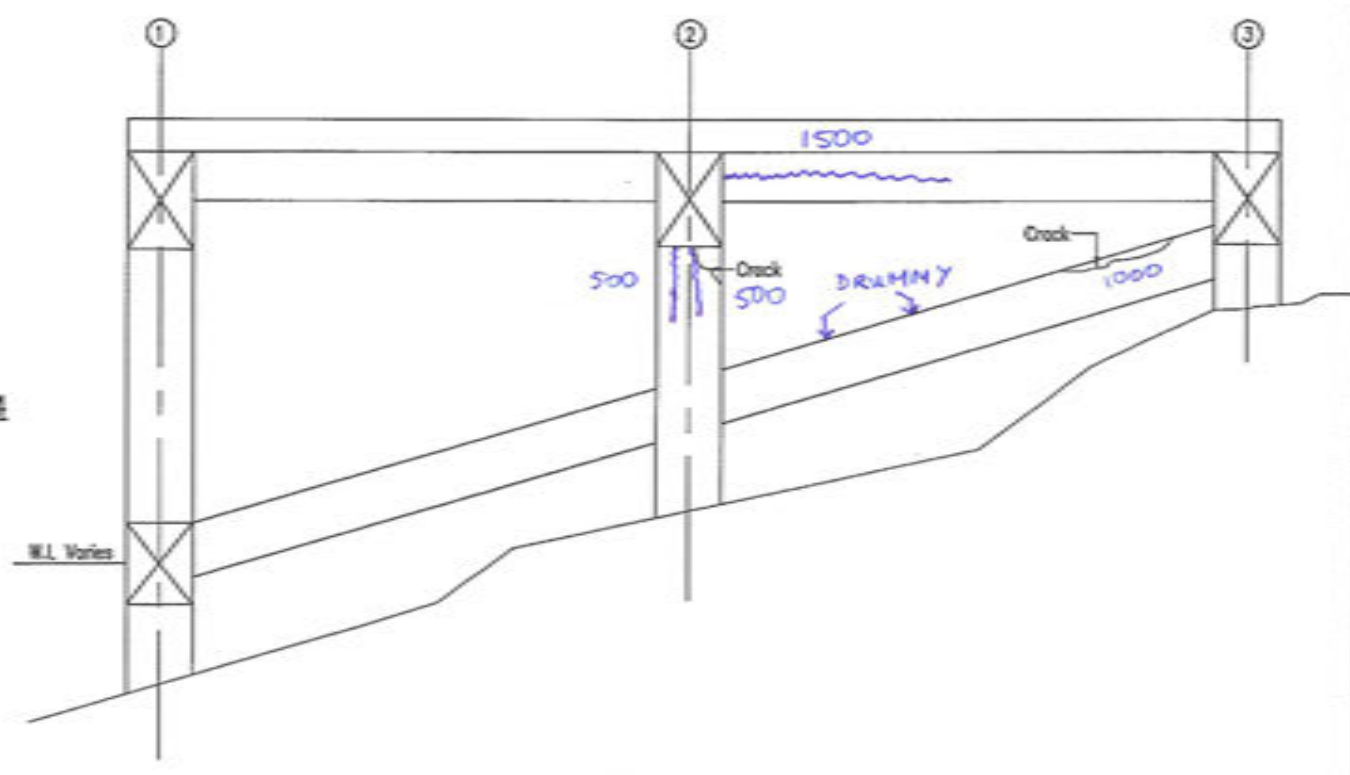

GRID ELEVATION - A4
Scale 1:25(A1)



LEGEND

-  Void in concrete
-  Spalling of concrete
-  Patch repair failure

NO.	BY	CHECKED	DATE
DESIGN			
DRAWN	K.Palpu	S.Kir	March 08
APPROVED			
REVISION			
APPROVED			

This drawing and its contents are the property of Opus International Consultants Limited. Any unauthorised employment or reproduction, in full or in part, is prohibited.



Hamilton Office

11 Pritchey Street
Hamilton, New Zealand

OPUS

Tel: +64 7 838 8294
Fax: +64 7 838 8294

FILE: WHAKATANE DISTRICT COUNCIL WHAKATANE WHARF : INSPECTION WHAKATANE			
1936 SECTION GRID ELEVATIONS A3-A4			
STATUS	DRIFT	FILE	288081.04
SCALE	AS SHOWN	PRINT DATE	14/03/08 @ 10:42
		FIGURE IDENTIFIER	2/214/177
		CODE	2204
		SHEET	2
		REVISION	RD

10/03/2008 13:01

GRAPHIC SCALES 1:25 0 100 200 300 400 500 600 700 800 900 1000 1100 1200 1300 1400 1500 1600 1700 1800 1900 2000 2100 2200 2300 2400 mm

0 10 mm
50
100
200
300 mm

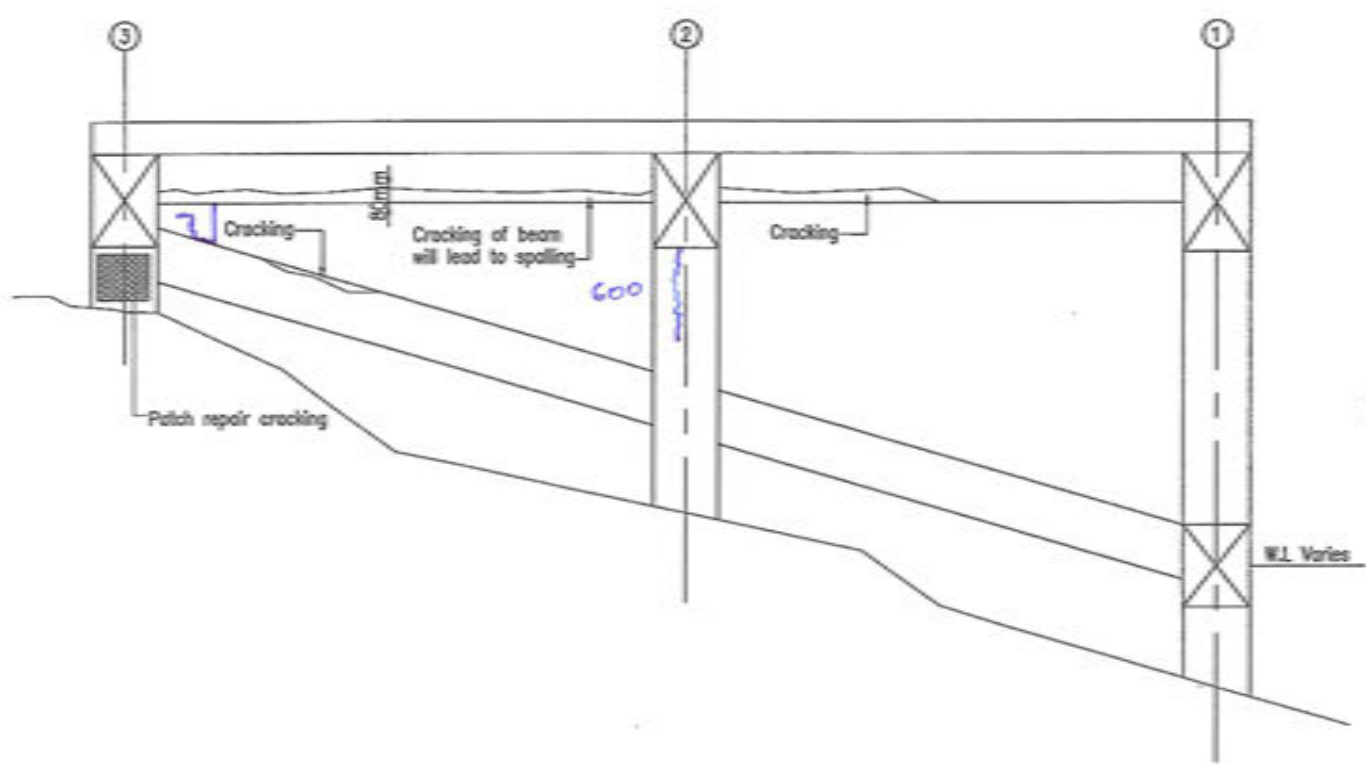

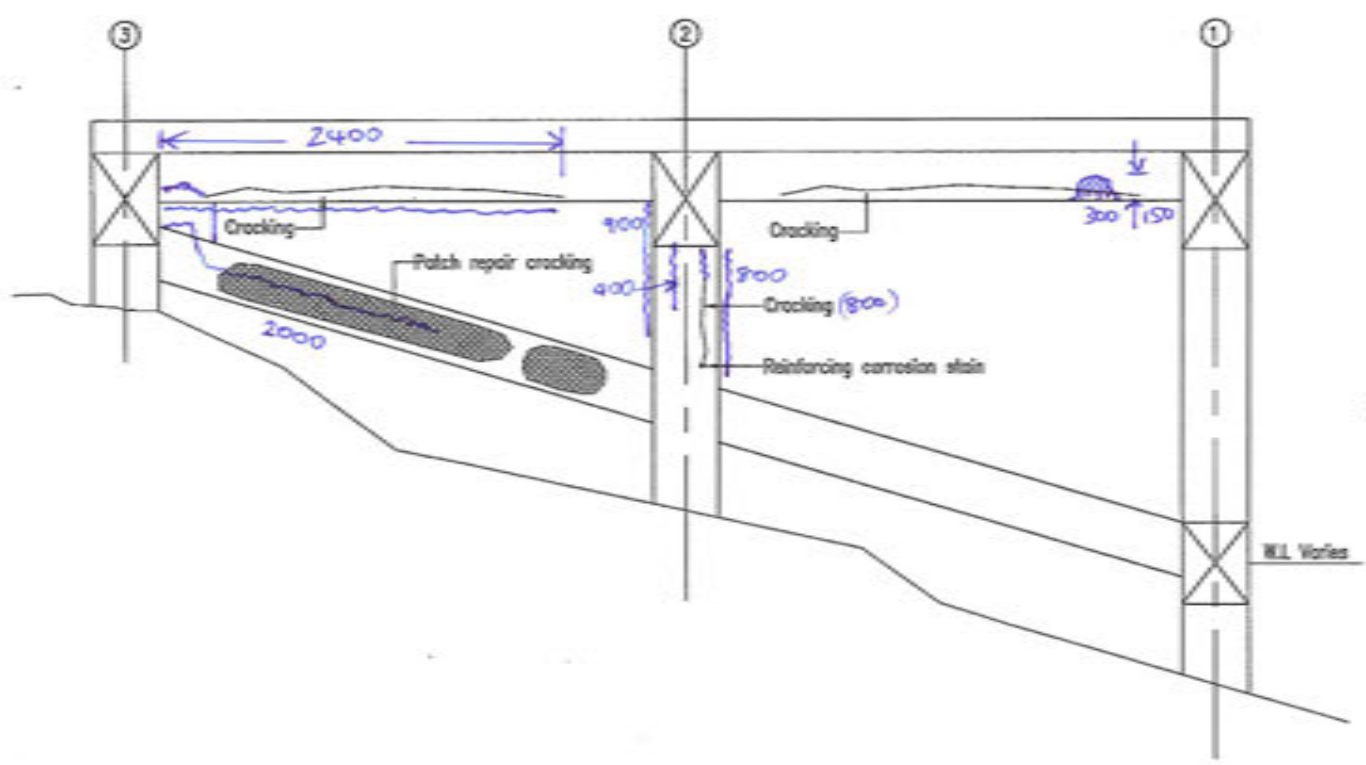
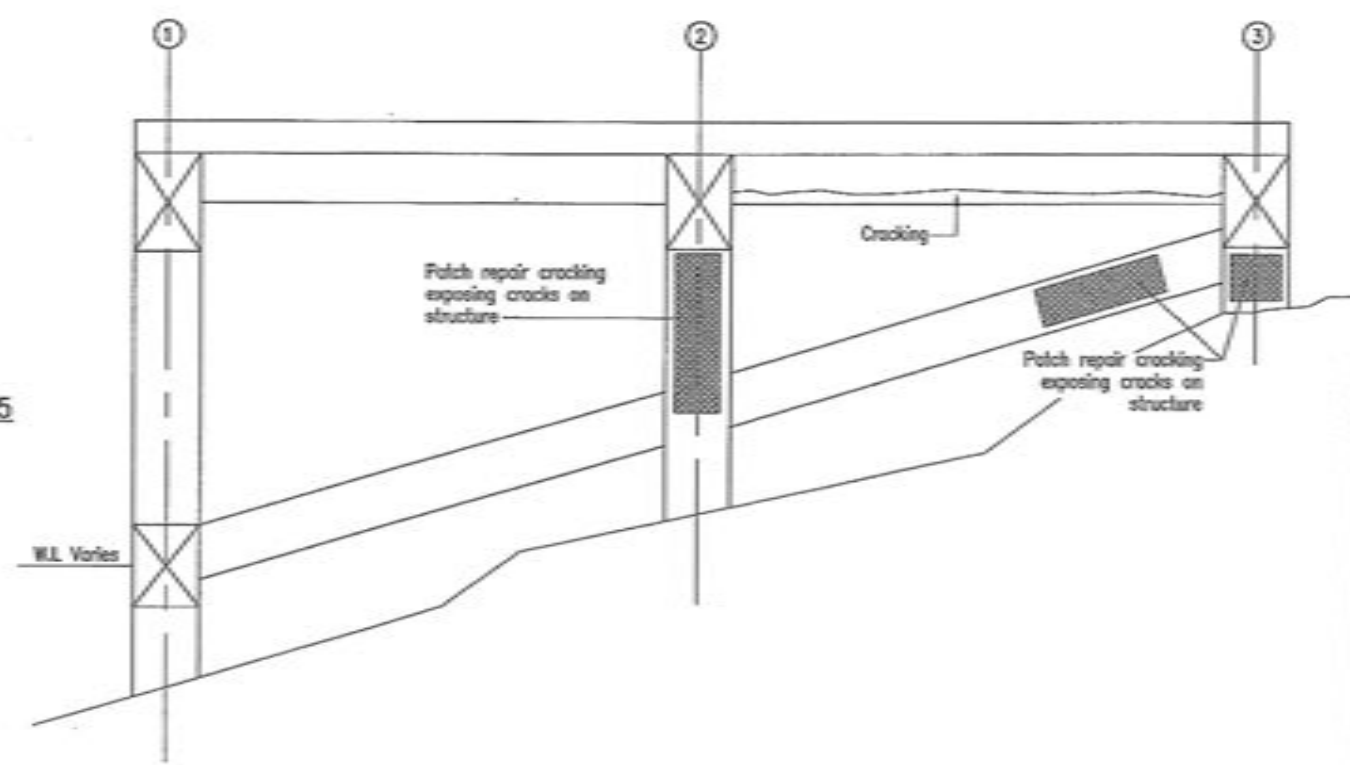

GRID ELEVATION - A5
Scale 1:25(A1)

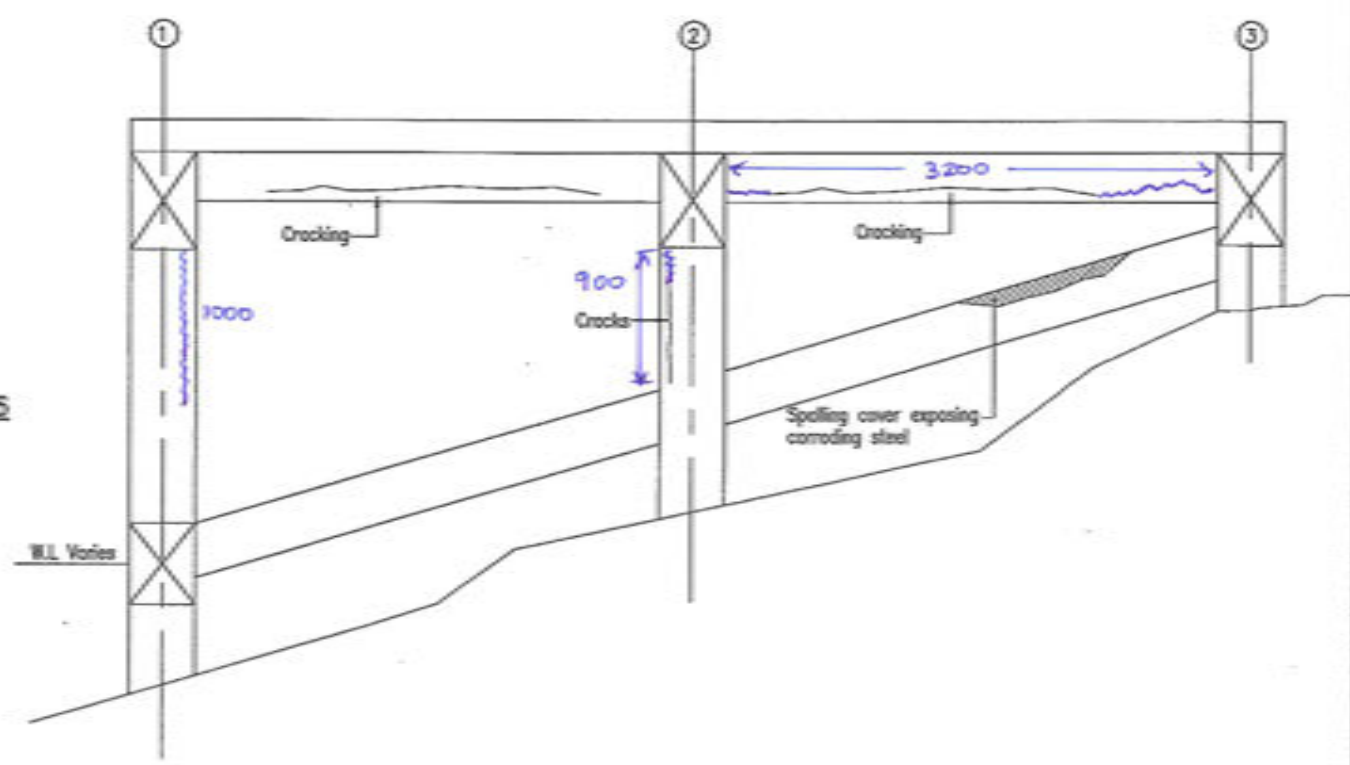

GRID ELEVATION - A6
Scale 1:25(A1)



LEGEND

-  Void in concrete
-  Spalling of concrete
-  Patch repair failure

NO.	BY	CHECKED	DATE
DESIGN			
DRAWN	R.P.P.	E.H.	March 08
APPROVED			
This drawing and its contents are the property of Opus International Consultants Limited. Any unauthorized employment or reproduction, in full or in part, is forbidden.			
REVISION	APP'D	DATE	



Hamilton Office
 Private Bag 3057
 Hamilton, New Zealand
 Tel: +64 7 838 8344
 Fax: +64 7 838 8324

OPUS

FILE: WYAKATANE DISTRICT COUNCIL WYAKATANE WHARF - INSPECTION WYAKATANE			
1936 SECTION GRID ELEVATIONS A5-A6			
STATUS: DRAFT	FILE: 258081.04		
SCALE: AS SHOWN	PLT DATE: 14/03/08 @ 10:42	FEATURE IDENTIFIER: 2/214/177	CODE: 2204
		SHEET: 3	REVISION: RD

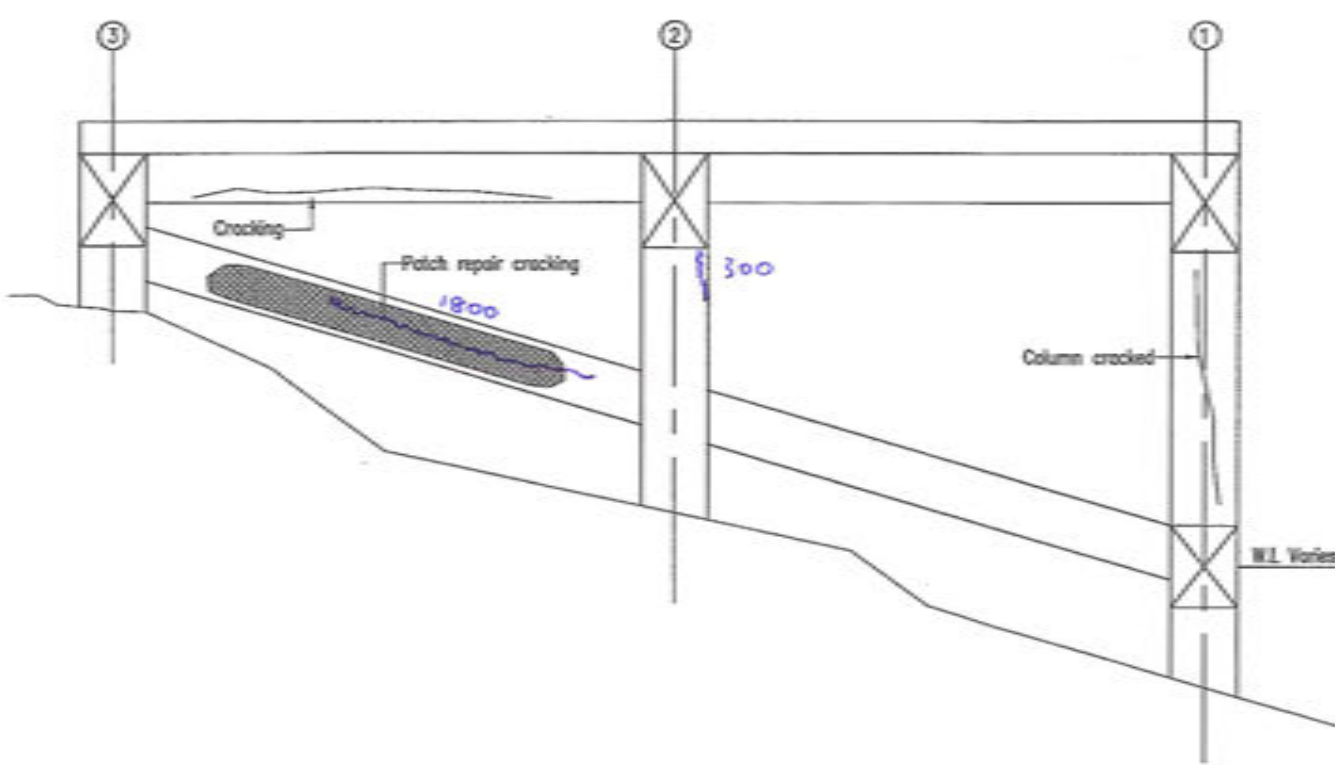

30 mm
20
10
0 10 mm
0 10 mm

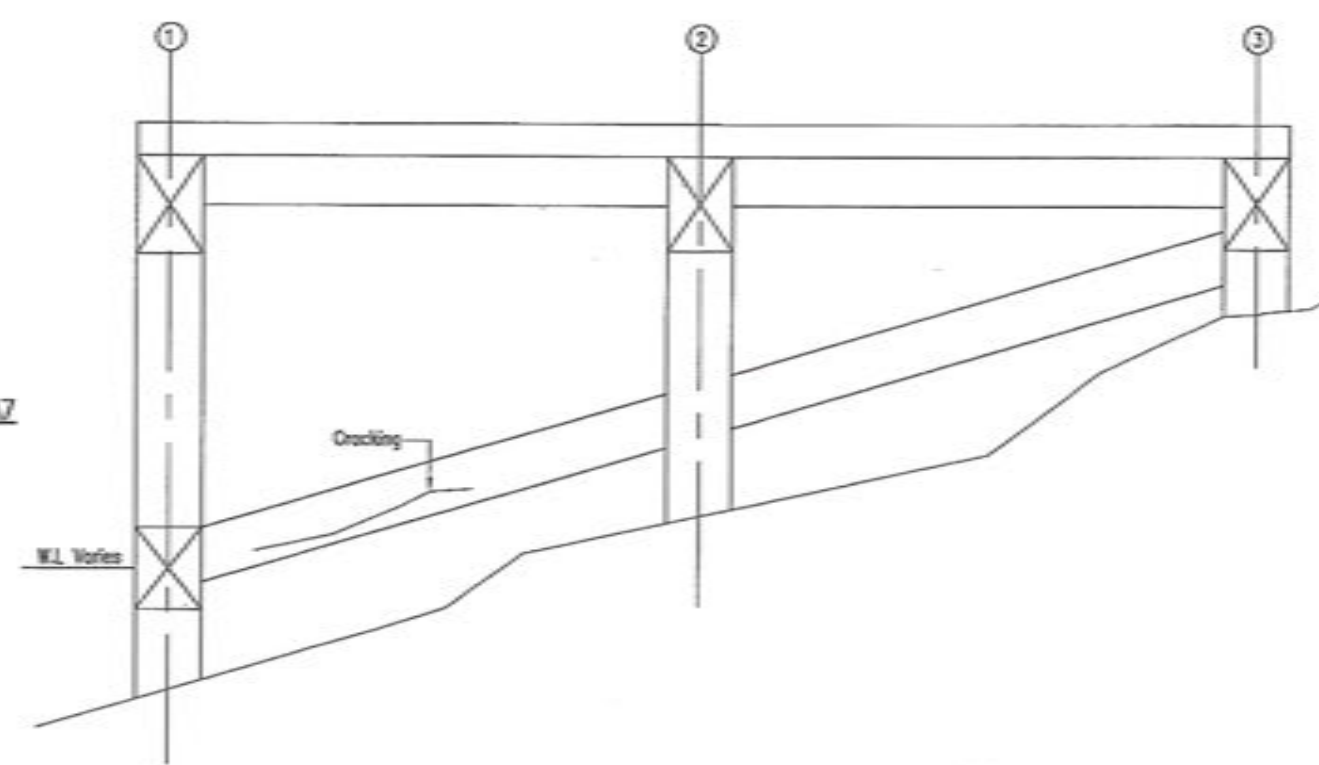

GRID ELEVATION - A7
Scale 1:25(A1)



LEGEND

-  Void in concrete
-  Spalling of concrete
-  Patch repair failure

NO.	BY	CHECKED	DATE
DESIGN			
DRAWN	K.Palmer	D.Mc	March 08
APPROVED			
This drawing and its contents are the property of Opus International Consultants Limited. Any unauthorised employment or reproduction, in full or in part, is forbidden.			
APPROVED	DATE		



Hamilton Office
 Plunket Bay 2007
 Hamilton, New Zealand
 Tel: +64 7 638 8244
 Fax: +64 7 638 8224

FILE: WHAKATANE DISTRICT COUNCIL WHAKATANE WHARF : INSPECTION WHAKATANE			
1936 SECTION GRID ELEVATION A7			
SKETCH	DRAFT	FILE	288081.04
SCALE	PLUT DATE	FIGURE NUMBER	CASE SHEET
AS SHOWN	14/03/08 @ 10:42	2/214/177	2204 4 RO

30/03/2008 13:02

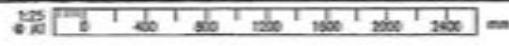

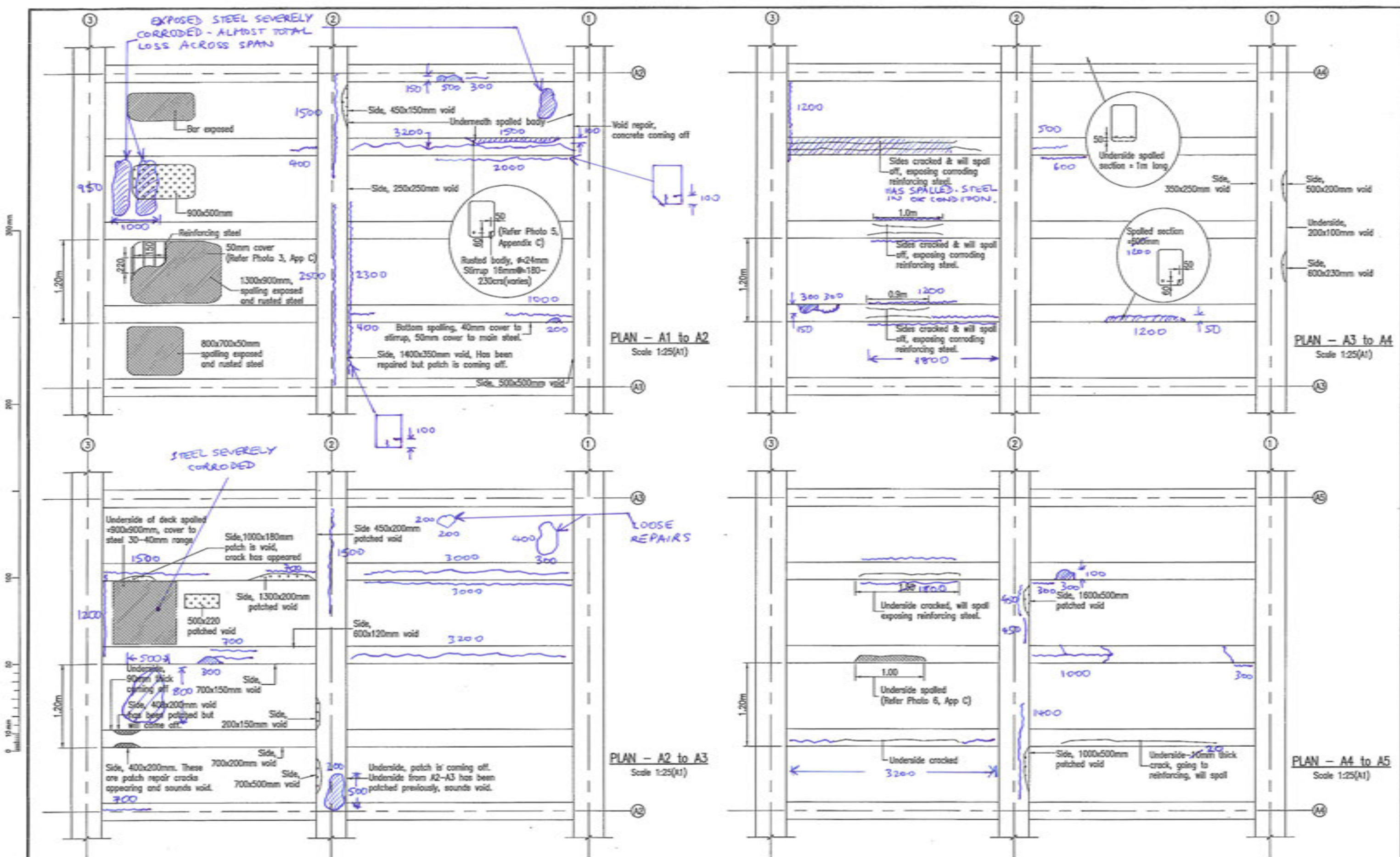

LEGEND

	Void in concrete
	Spalling of concrete
	Patch repair failure

NO.	REV.	DATE	BY	CHECKED	DATE
DESIGN					
DRAWN			K.P.M.	S.M.	March 08
APPROVED					

This drawing and its contents are the property of Opus International Consultants Limited. Any unauthorised employment or reproduction, in full or in part, is forbidden.

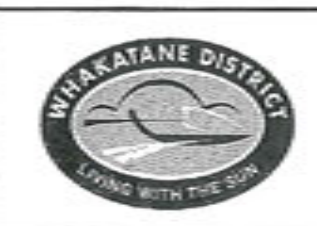

Hamilton Office

Private Bag 357
Hamilton, New Zealand

TEL: +64 7 838 8344
FAX: +64 7 838 8324

OPUS

FILE: WHAKATANE DISTRICT COUNCIL WHAKATANE WHARF : INSPECTION WHAKATANE					
1936 SECTION PLAN BETWEEN GRIDS A1/A2, A2/A3, A3/A4, A4/A5					
SCALE	DATE	REVISION	NO.	SHEET	REGION
AS SHOWN	14/03/08 @ 10:42	2/214/177	2204	5	RD

30/03/2008 13:02

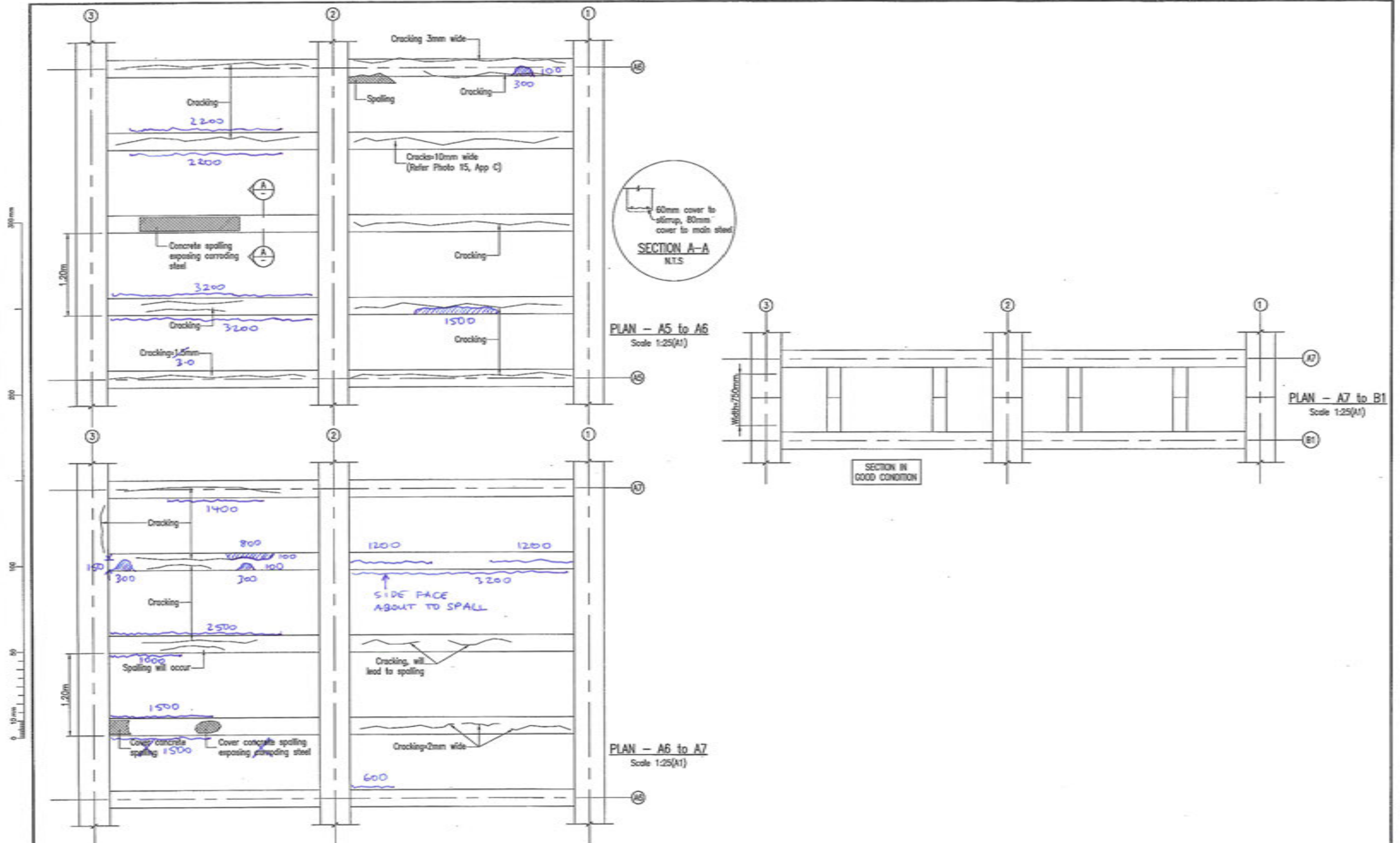

LEGEND

	Void in concrete
	Spalling of concrete
	Patch repair failure

NO.	REVISION	DATE	BY	CHECKED	DATE

DESIGN: BY: CHECKED: DATE:
DRAWN: N.Palyn S.Muir March 08
APPROVED:
This drawing and its contents are the property of Opus International Consultants Limited. Any unauthorised employment or reproduction, in full or in part, is forbidden.



Hamilton Office

OPUS

Private Bag 307
Hamilton, New Zealand
Tel: +64 7 838 8344
Fax: +64 7 838 8324

FILE: WHAKATANE DISTRICT COUNCIL WHAKATANE WHARF - INSPECTION WHAKATANE					
1936 SECTION PLAN BETWEEN GRIDS A5/A6, A6/A7, A7/B1					
DRAWN	DRAFT	FILE	288081.04		
SCALE	PLUF DATE	FIGURE NUMBER	CODE	SHEET	REVISION
AS SHOWN	14/03/08 @ 10:42	2/214/177	2204	6	RO

20/03/2008 13:24

0 10mm 20 30 40 50 60 70 80 90 100 110 120 130 140 150 160 170 180 190 200 210 220 230 240 250

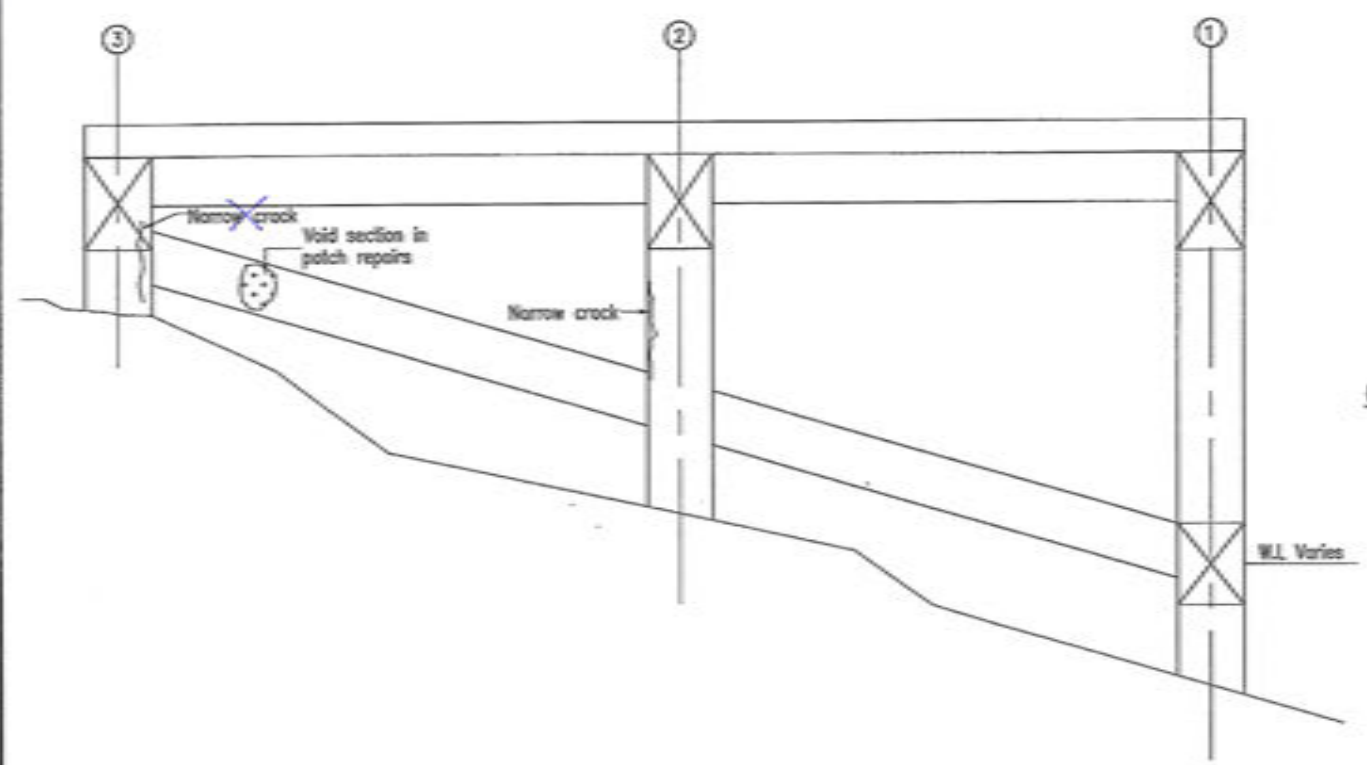

GRID ELEVATION - B1
Scale 1:25(A1)

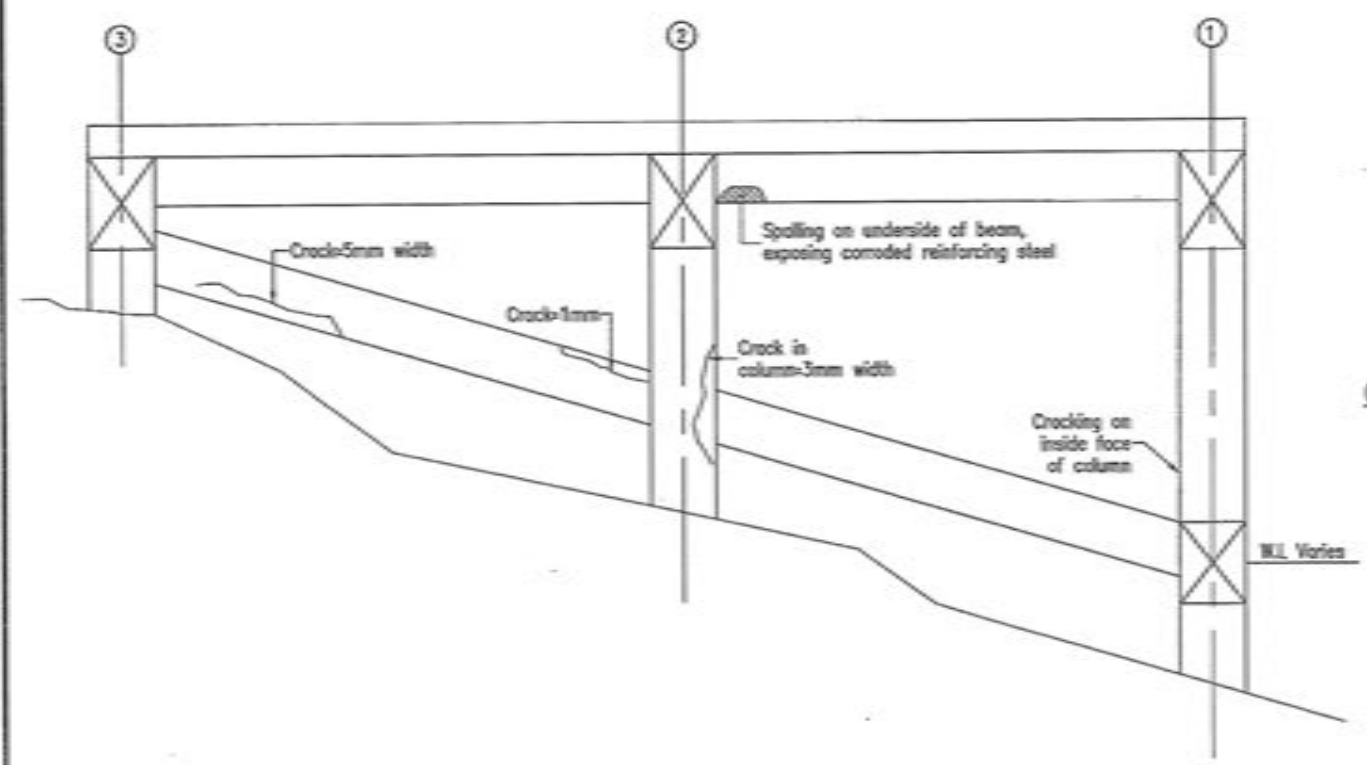
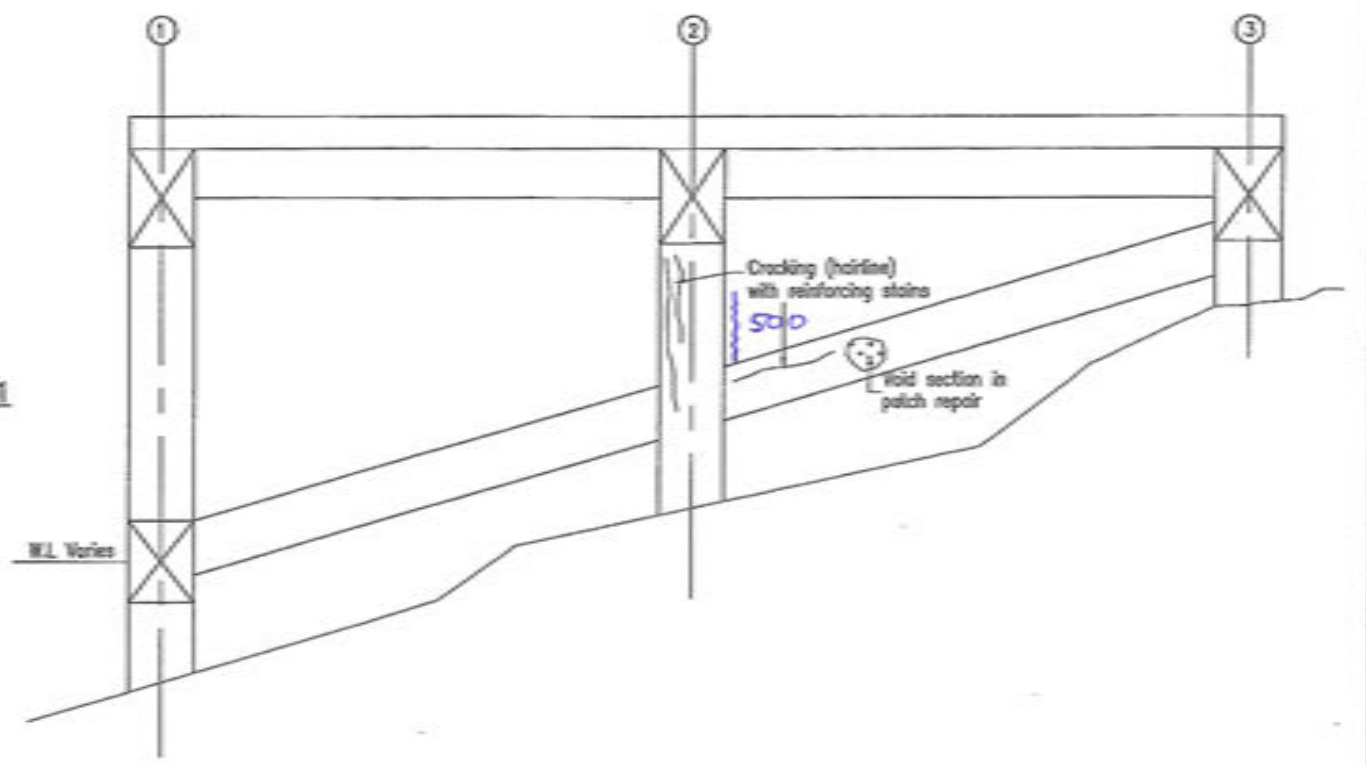

GRID ELEVATION - B2
Scale 1:25(A1)

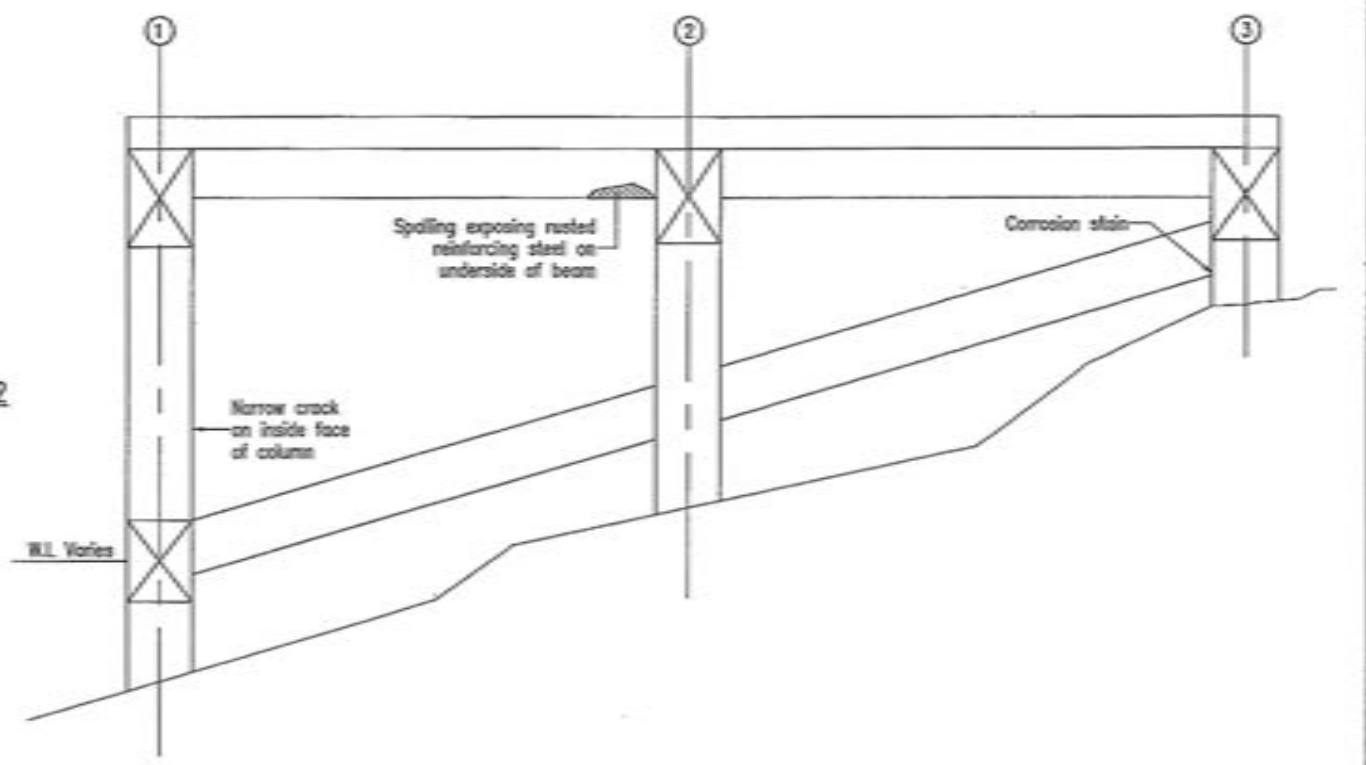

LEGEND

- Void in concrete
- Spalling of concrete
- Patch repair failure

NO.	BY	CHECKED	DATE
DESIGN			
DRAWN	K.Poly	S.Mc	March 2008
APPROVED			
REVISION			
NO.	DATE	BY	DESCRIPTION



Hamilton Office
 Opus
 Phone: 054 7 830 834
 Fax: 054 7 830 834

PROJECT: WHAKATANE DISTRICT COUNCIL WHAKATANE WHARF : INSPECTION WHAKATANE			
SECTION: 1940 SECTION GRID ELEVATIONS B1-B2			
STATUS: DRAFT	FILE: 288081.04		
SCALE: AS SHOWN	PLUT DATE: 14/03/08 @ 10:44	FEATURE IDENTIFIER: 2/214/177	CODE: 2204
		SHEET: 7	REVISION: RO

26/03/2008 8:17

GRAPHIC SCALE 1:25 @ A1 0 400 800 1200 1600 2000 2400 mm

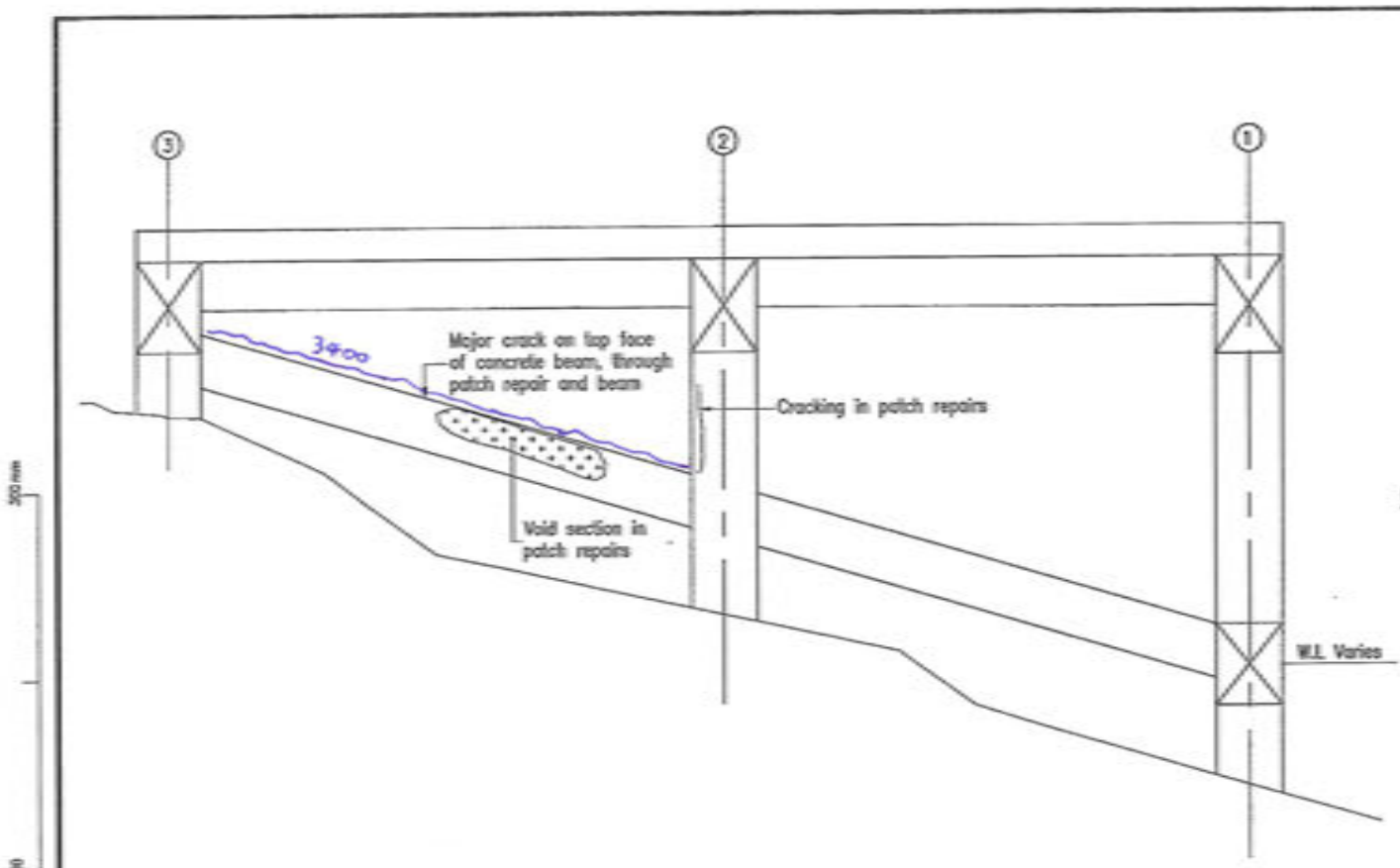

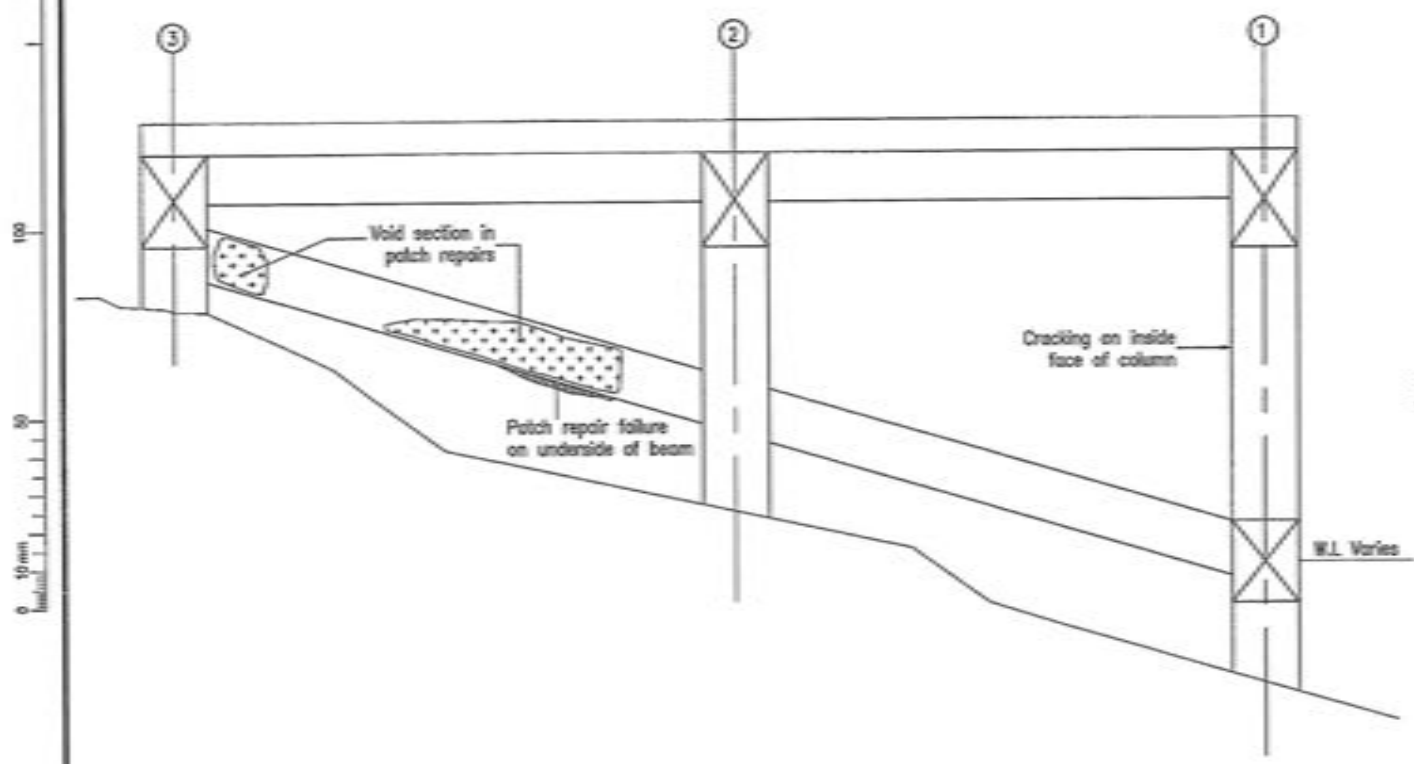
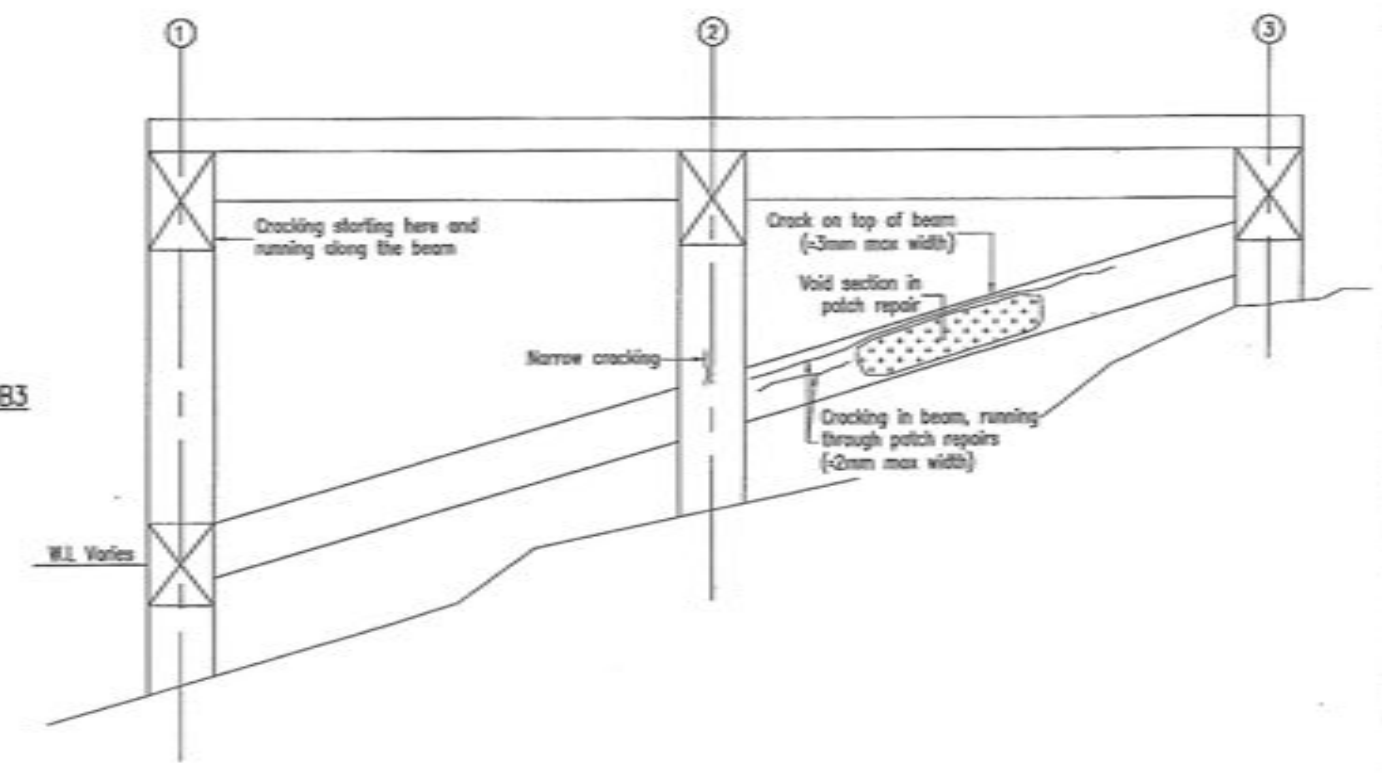

GRID ELEVATION - B3
Scale 1:25(A1)

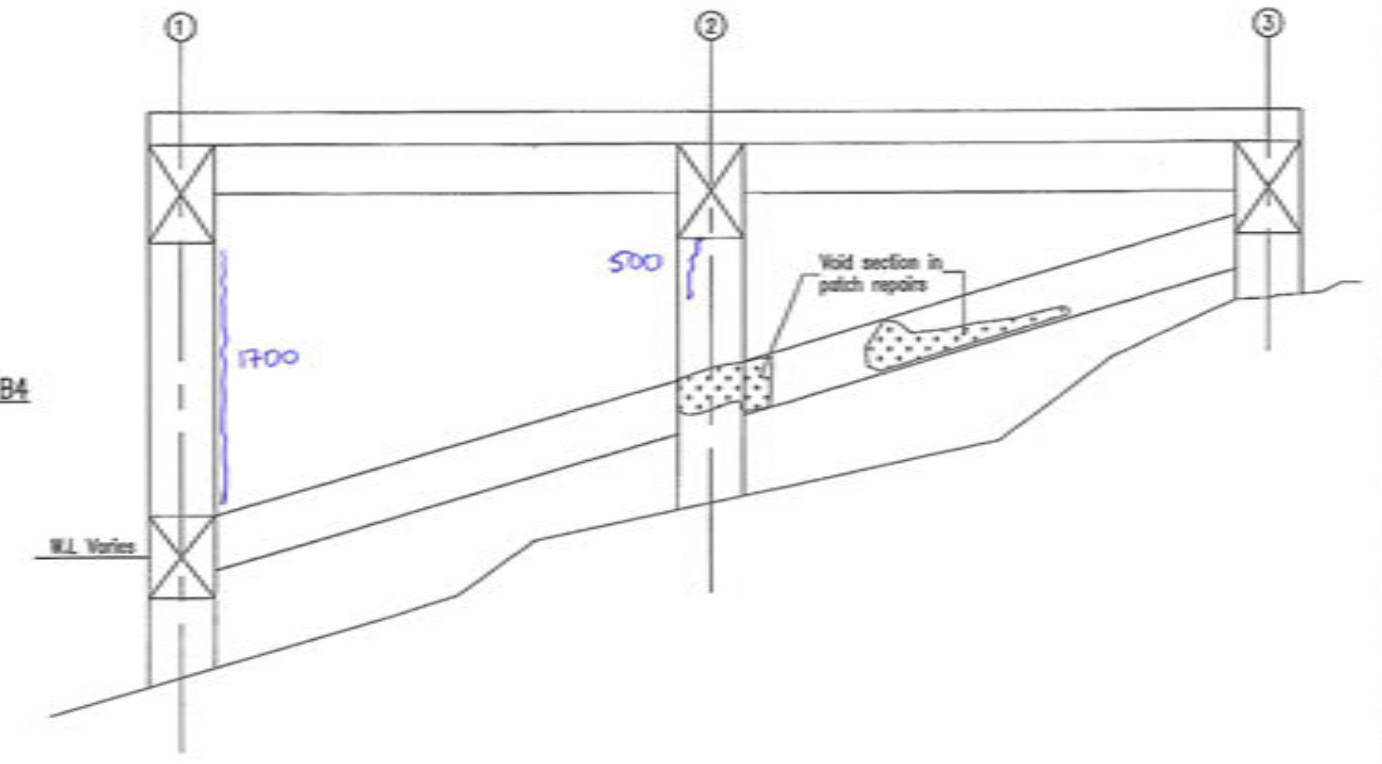

GRID ELEVATION - B4
Scale 1:25(A1)



LEGEND

-  Void in concrete
-  Spalling of concrete
-  Patch repair failure

NO.	REVISION	BY	CHECKED	DATE
1	DESIGN	BY	CHK	March 2008
2	DOWN	K.P.	CHK	March 2008
3	APPROVED			

This drawing and its contents are the property of Opus International Consultants Limited. Any unauthorised employment or reproduction, in full or in part, is forbidden.



Hamilton Office
 Phone: 07 357 8000
 Fax: 07 357 8001
 Email: info@opus.co.nz

FILE: WHAKATANE DISTRICT COUNCIL WHAKATANE WHARF : INSPECTION WHAKATANE			
1940 SECTION GRID ELEVATIONS B3-B4			
DRIFT	REV	288081.04	
SCALE	PLT DATE	FEATURE NUMBER	CODE SHEET REGION
AS SHOWN	14/03/08 @ 10:44	2/214/177	2204 8 RO

28/03/2008 8:11

0 100 200 300 mm

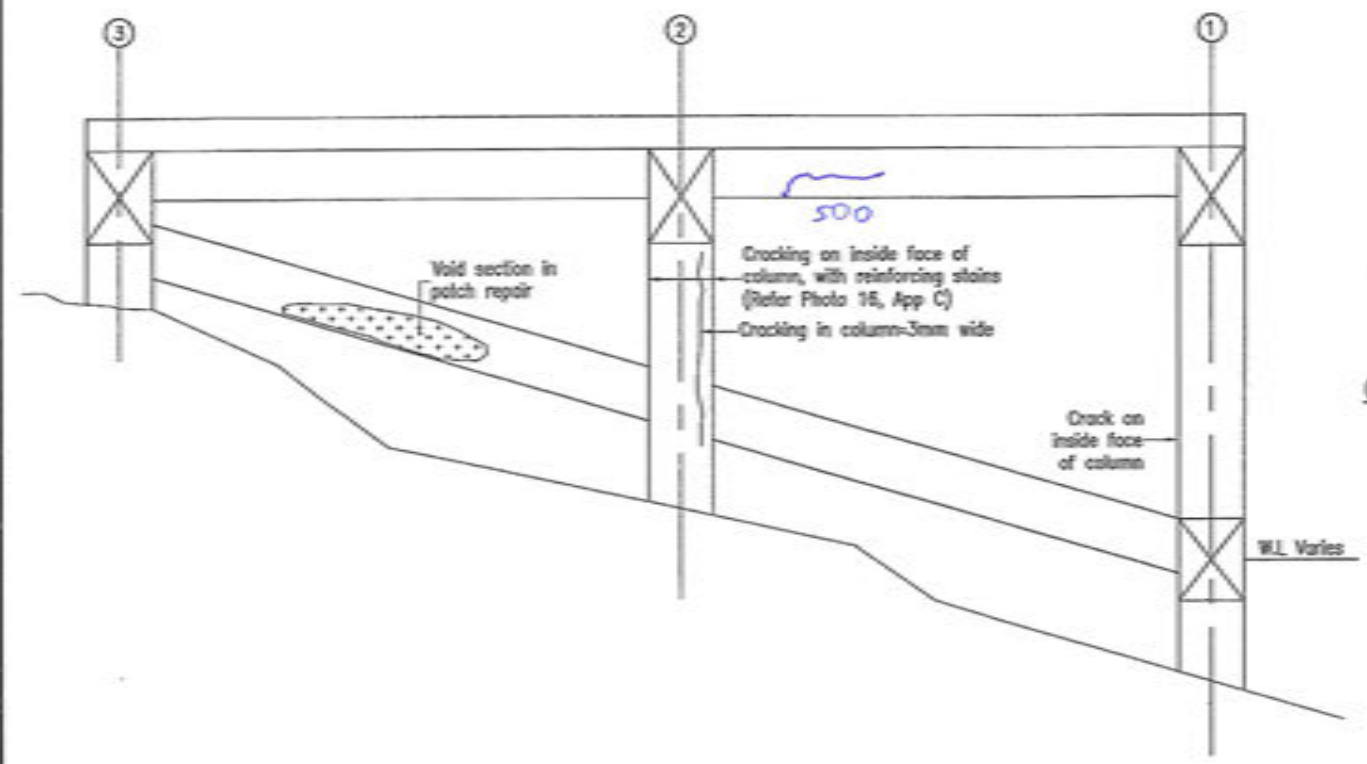

GRID ELEVATION - B5
Scale 1:25(A1)

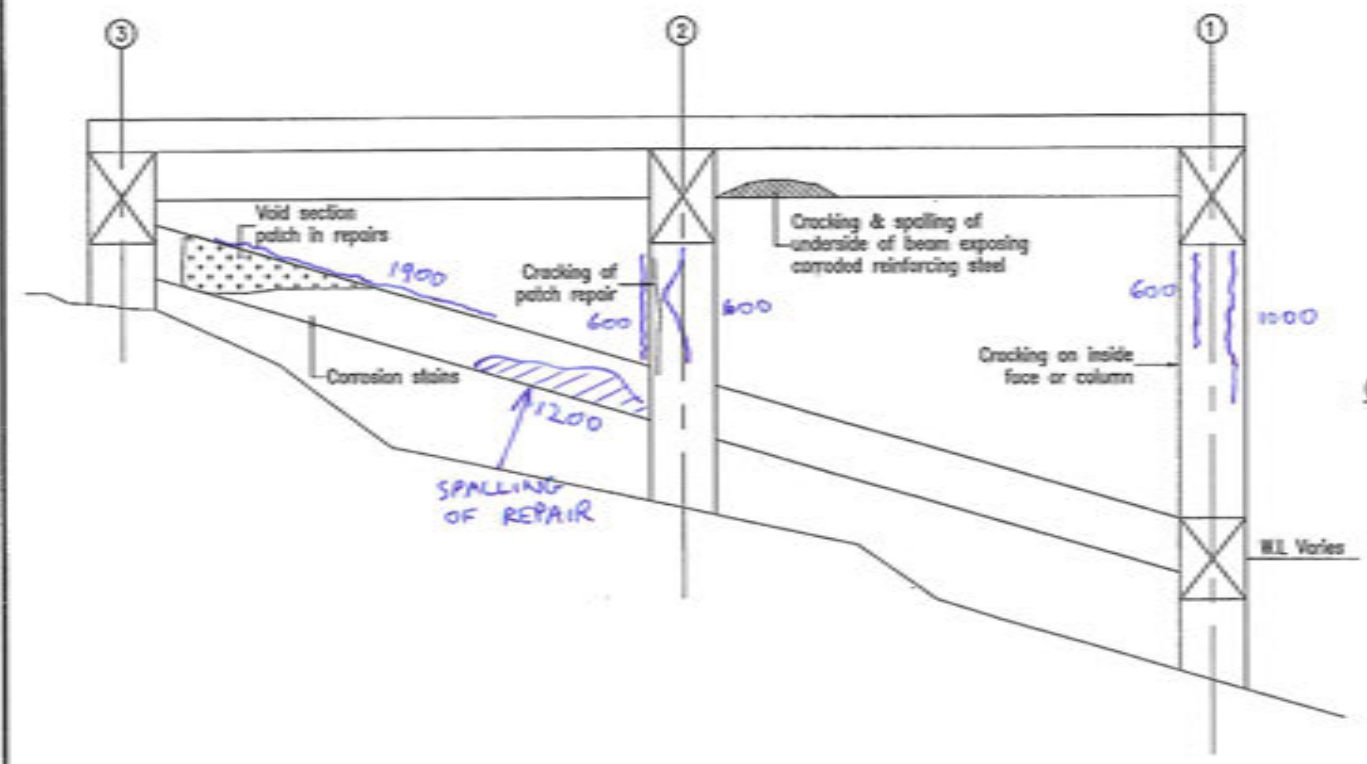
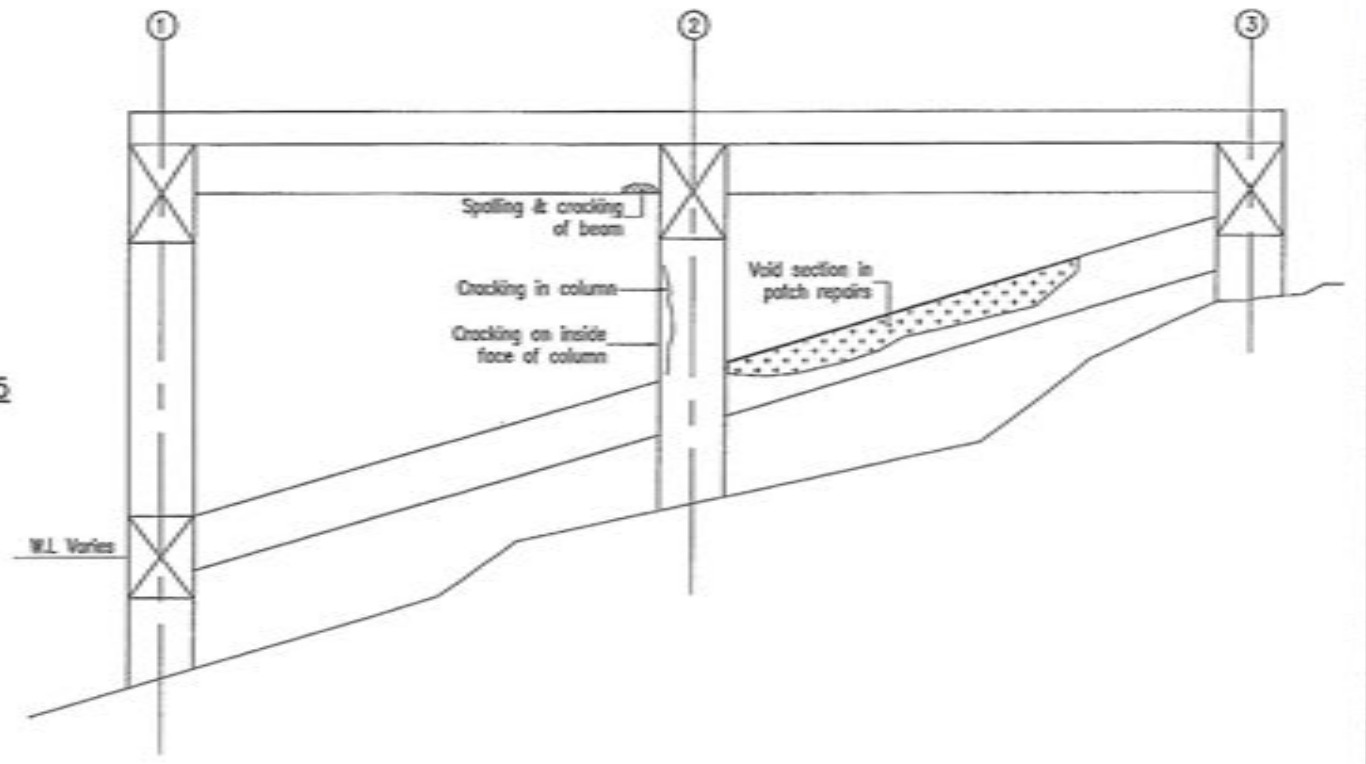

GRID ELEVATION - B6
Scale 1:25(A1)

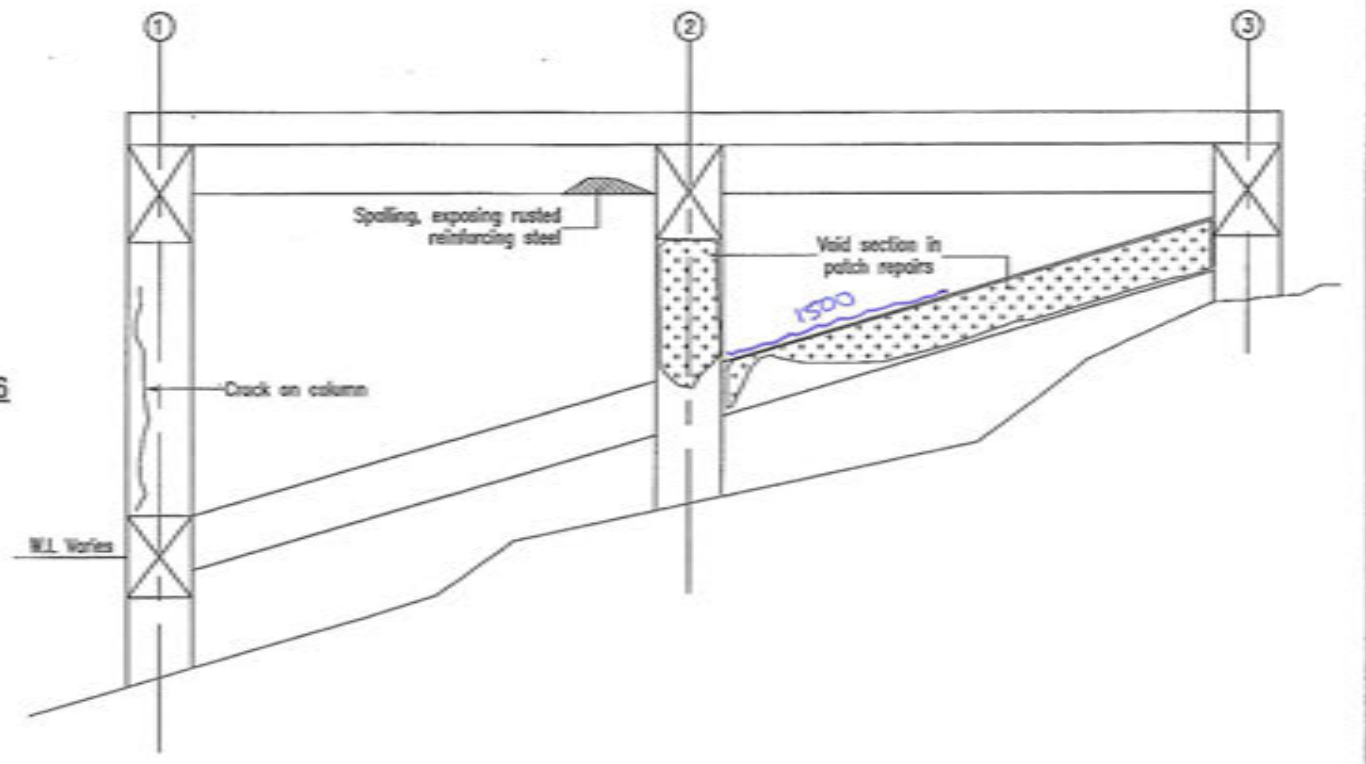

LEGEND

- Void in concrete
- Spalling of concrete
- Patch repair failure

NO.	BY	DESIGN	DATE
DESIGN	BY	DATE	March 2008
APPROVED			
APPROVED			

This drawing and its contents are the property of Opus International Consultants Limited. Any unauthorised employment or reproduction, in full or in part, is forbidden.



Hamilton Office
 Opus
 Phone 07 3257
 Hamilton, New Zealand
 Tel: +64 7 838 8244
 Fax: +64 7 838 8244

Wairarapa District Council Wairarapa Wharf - Inspection Wairarapa			
1940 SECTION GRID ELEVATIONS B5-B6			
SCALE	DRAFT	FILE	258081.04
AS SHOWN	PLUT DATE 14/03/08 @ 10:44	REVISION NUMBER 2/214/177	CODE 2204
		SHEET 9	REVISION RD

16/03/2008 8:18

GRAPHIC SCALE 1:25 @ A1 0 500 1000 1500 2000 2500 mm

0 10 mm
50
100
200
300 mm

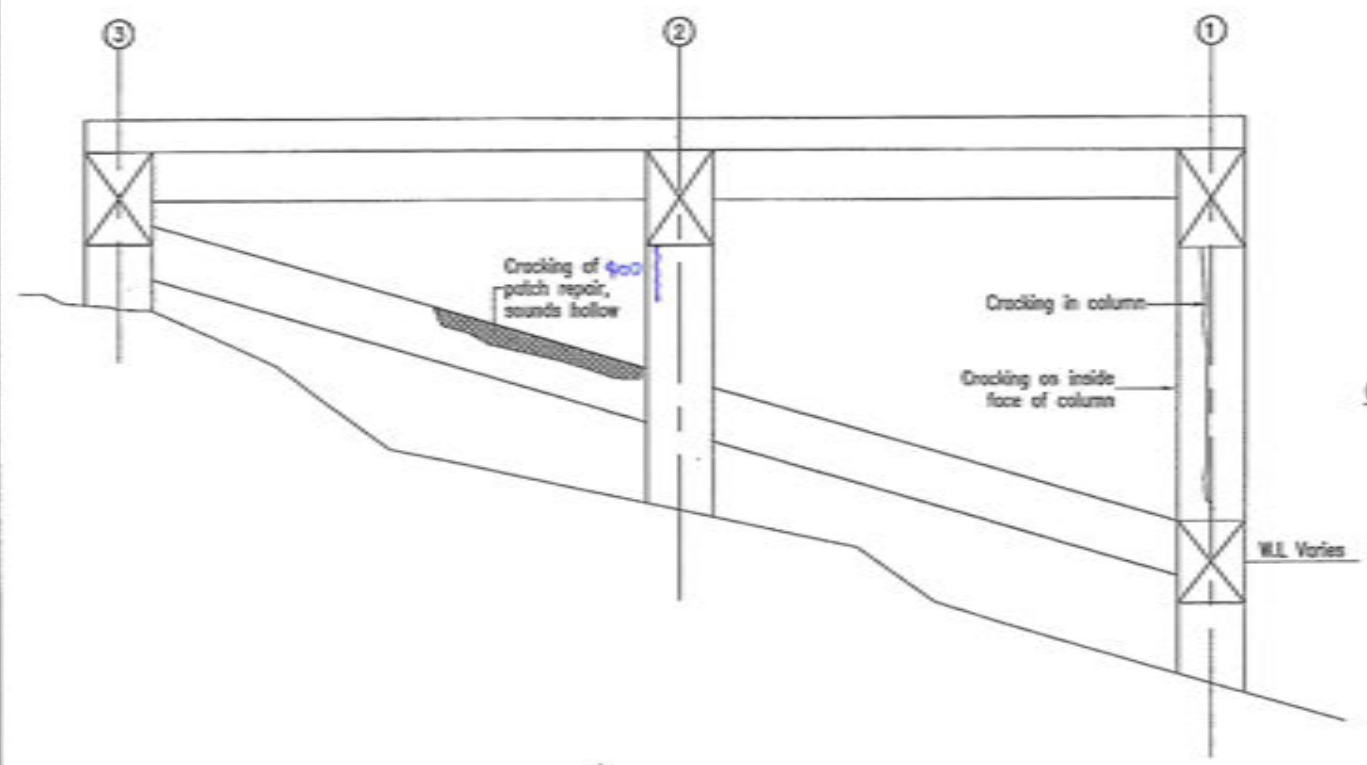

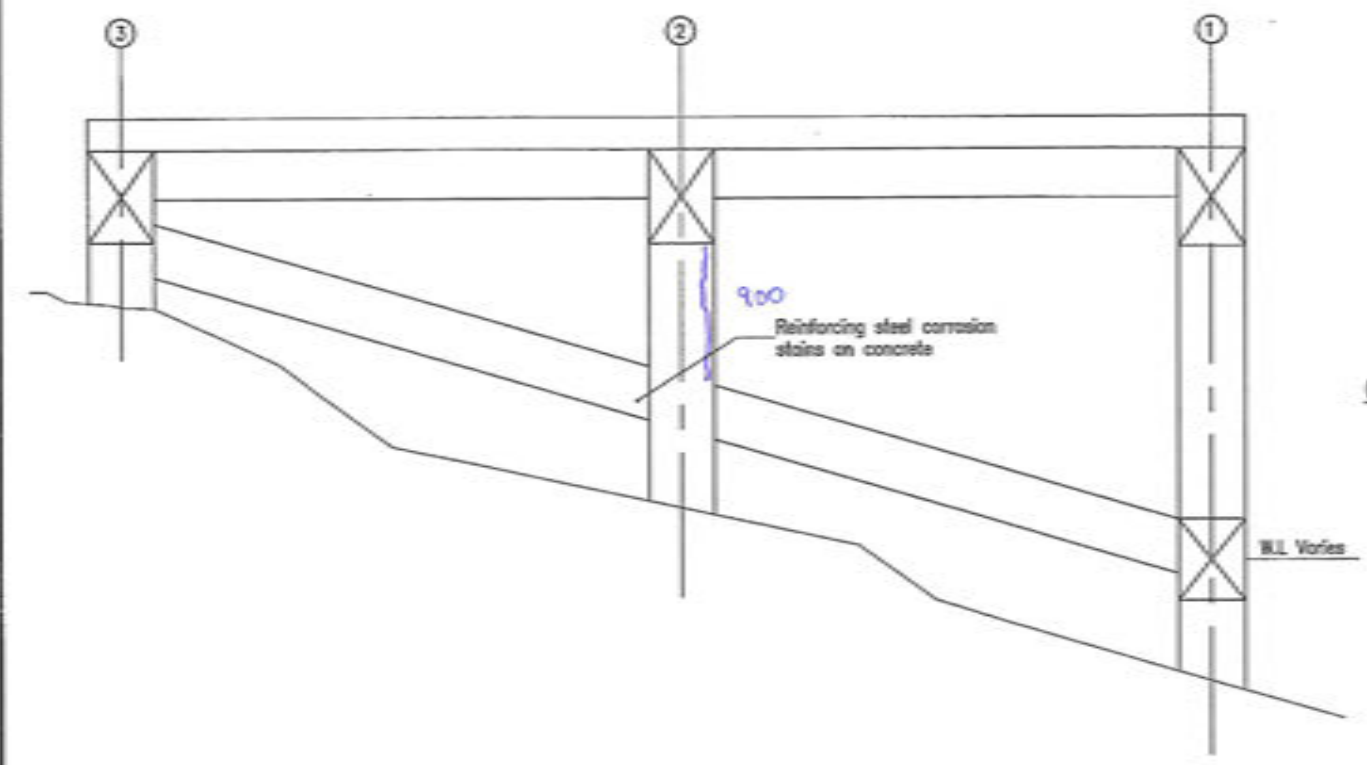
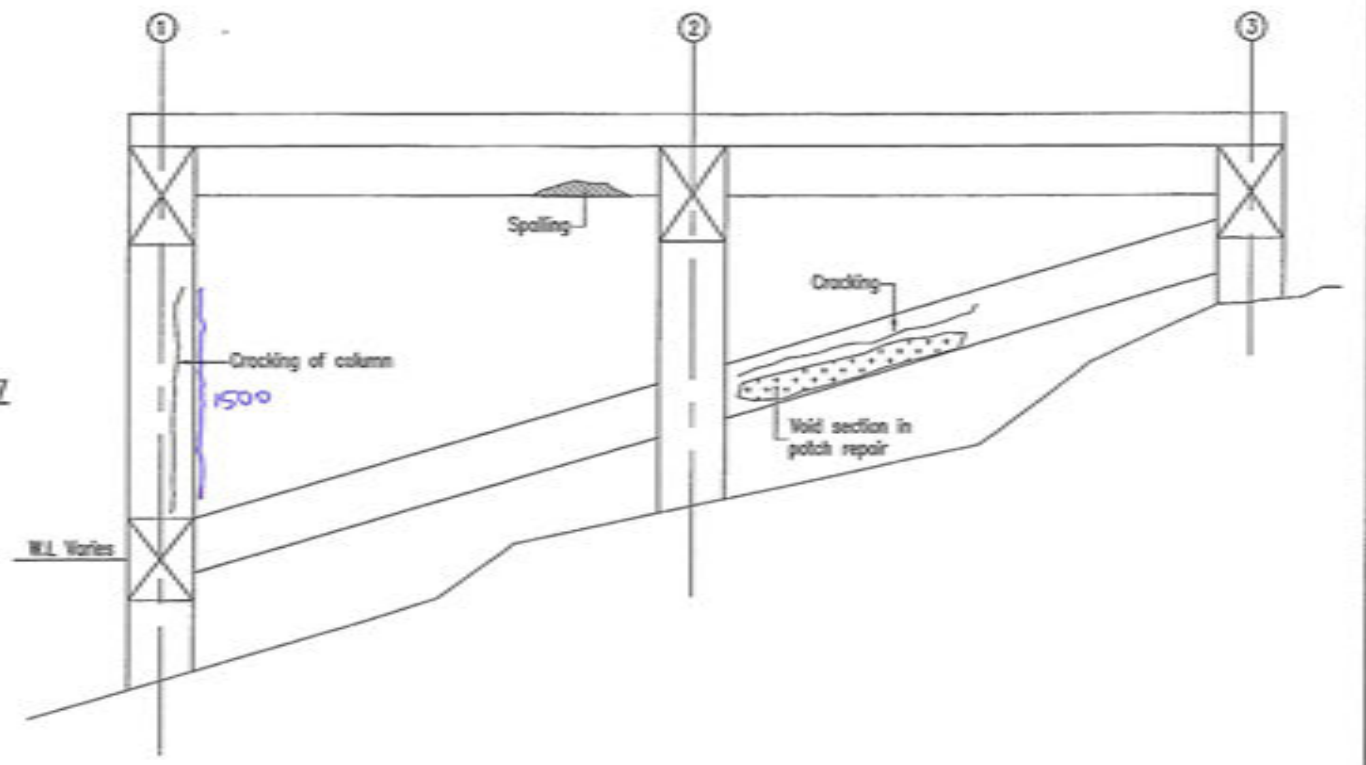

GRID ELEVATION - B7
Scale 1:25(A1)

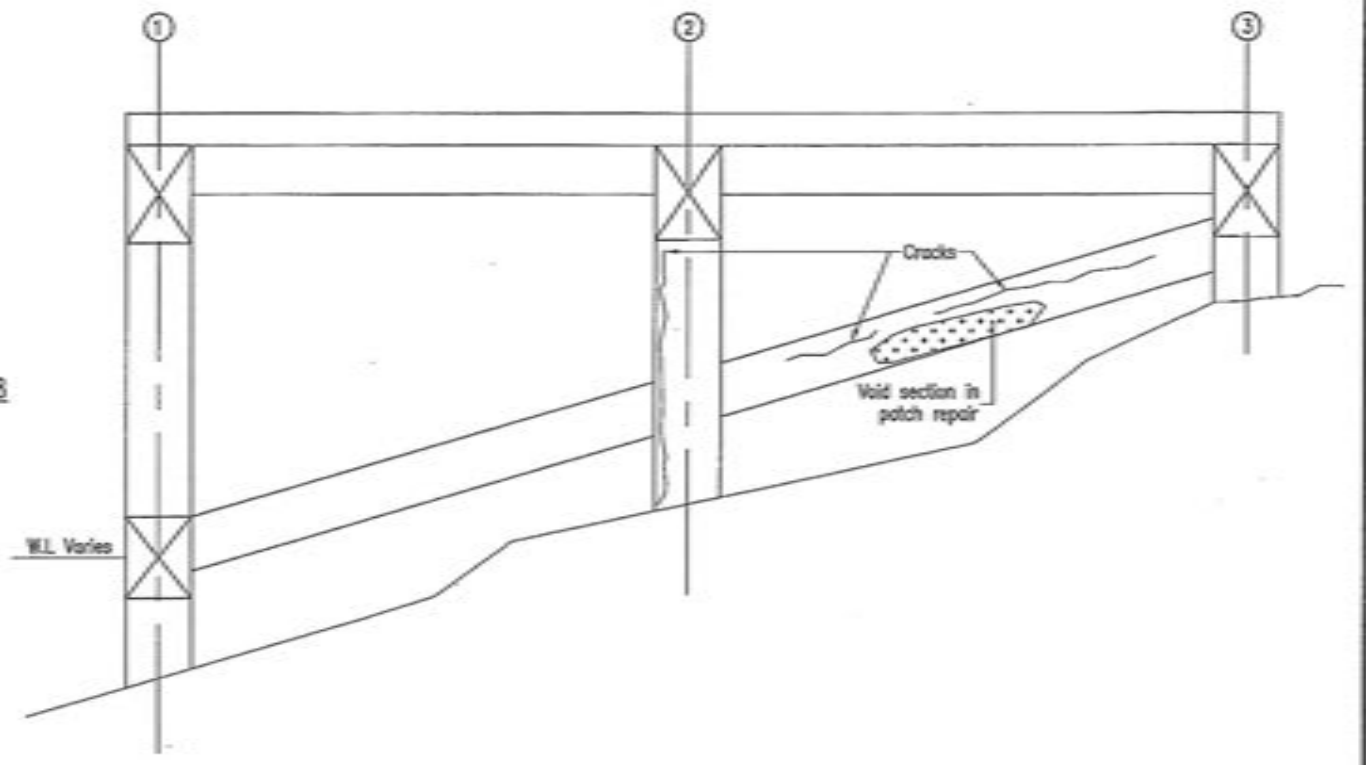

GRID ELEVATION - B8
Scale 1:25(A1)



LEGEND

-  Void in concrete
-  Spalling of concrete
-  Patch repair failure

NO.	BY	CHECKED	DATE
DESIGN			
DRAWN	K.Poly	S.Nair	March 2008
APPROVED			
AMENDMENT	APP'D	DATE	

This drawing and its contents are the property of Opus International Consultants Limited. Any unauthorised employment or reproduction, in full or in part, is forbidden.



Hamilton Office
 Private Bag 2057
 Hamilton, New Zealand
 Tel: +64 7 838 8244
 Fax: +64 7 838 8224

FILE WHAKATANE DISTRICT COUNCIL WHAKATANE WHARF : INSPECTION WHAKATANE			
1940 SECTION GRID ELEVATIONS B7-B8			
DATE	DRAFT	FILE	288081.04
SCALE	PLUT DATE	GENERIC IDENTIFIER	CASE SHEET REGION
AS SHOWN	14/03/08 @ 10:44	2/214/177	2204 10 R0

14/03/2008 04:18

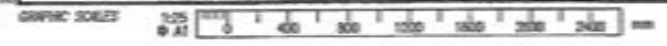

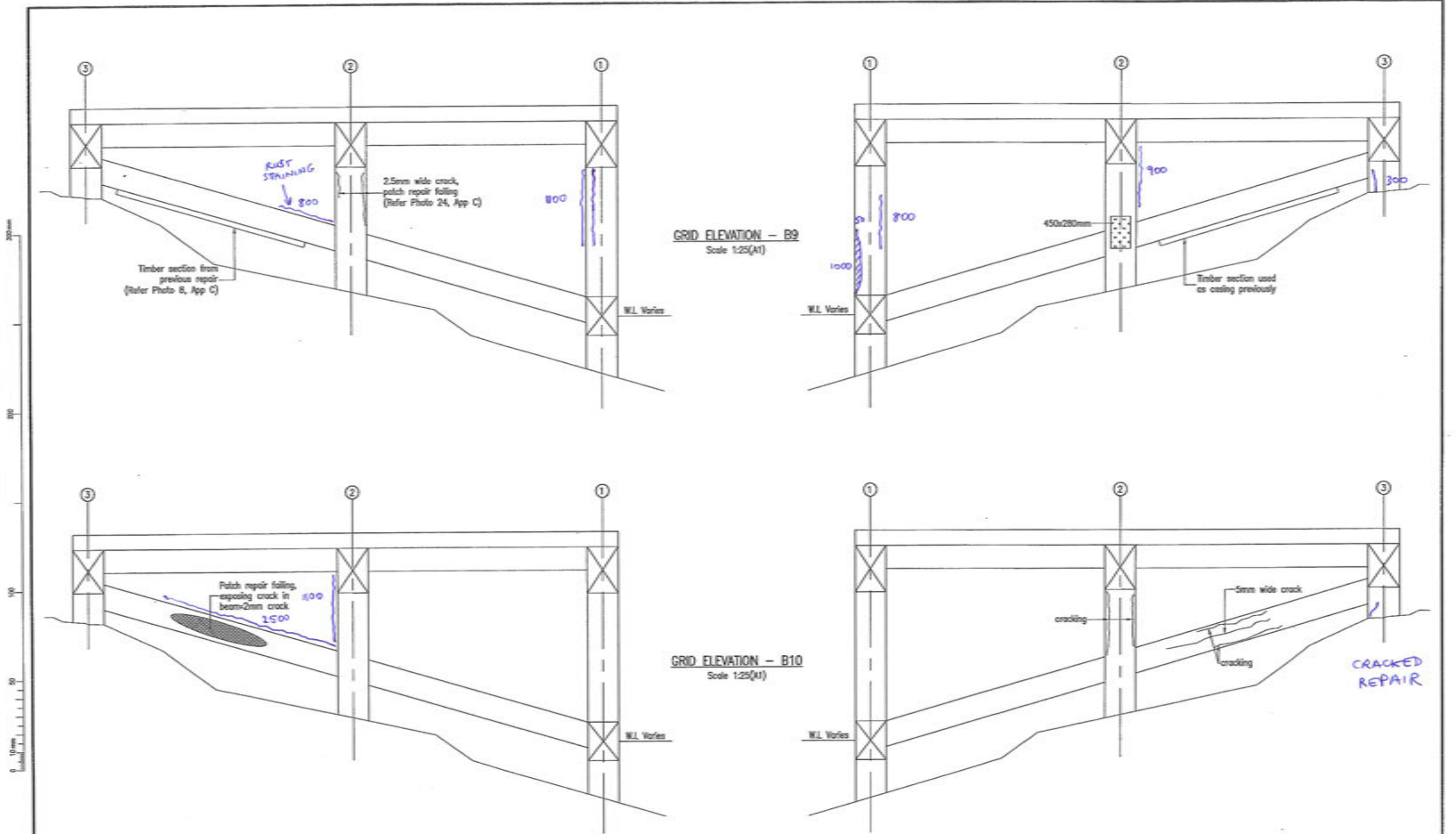



GRID ELEVATION - B9
Scale 1:25(A1)

GRID ELEVATION - B10
Scale 1:25(A1)

LEGEND

-  Void in concrete
-  Spalling of concrete
-  Patch repair failure

NO	BY	CHECKED	DATE
DESIGN			
DRAWN	KP/lyn	DLR	March 2008
APPROVED			
AGENCY	APPD	DATE	



Hamilton Office

Private Bag 3007
Bluffton, New Zealand

Tel: +64 7 838 8341
Fax: +64 7 838 8324

OPUS

FILE: WAKATANE DISTRICT COUNCIL WAKATANE WHARF : INSPECTION WAKATANE			
1940 SECTION GRID ELEVATIONS B9-B10			
STATUS	DRAFT	FILE	288081.D4
SCALE	AS SHOWN	PLT DATE	14/03/08 @ 10:44
FIGURE NUMBER	2/214/177	CODE	2204
SHEET	11	REVISION	RO

25/03/2008 1:16



300 mm
100
10 mm

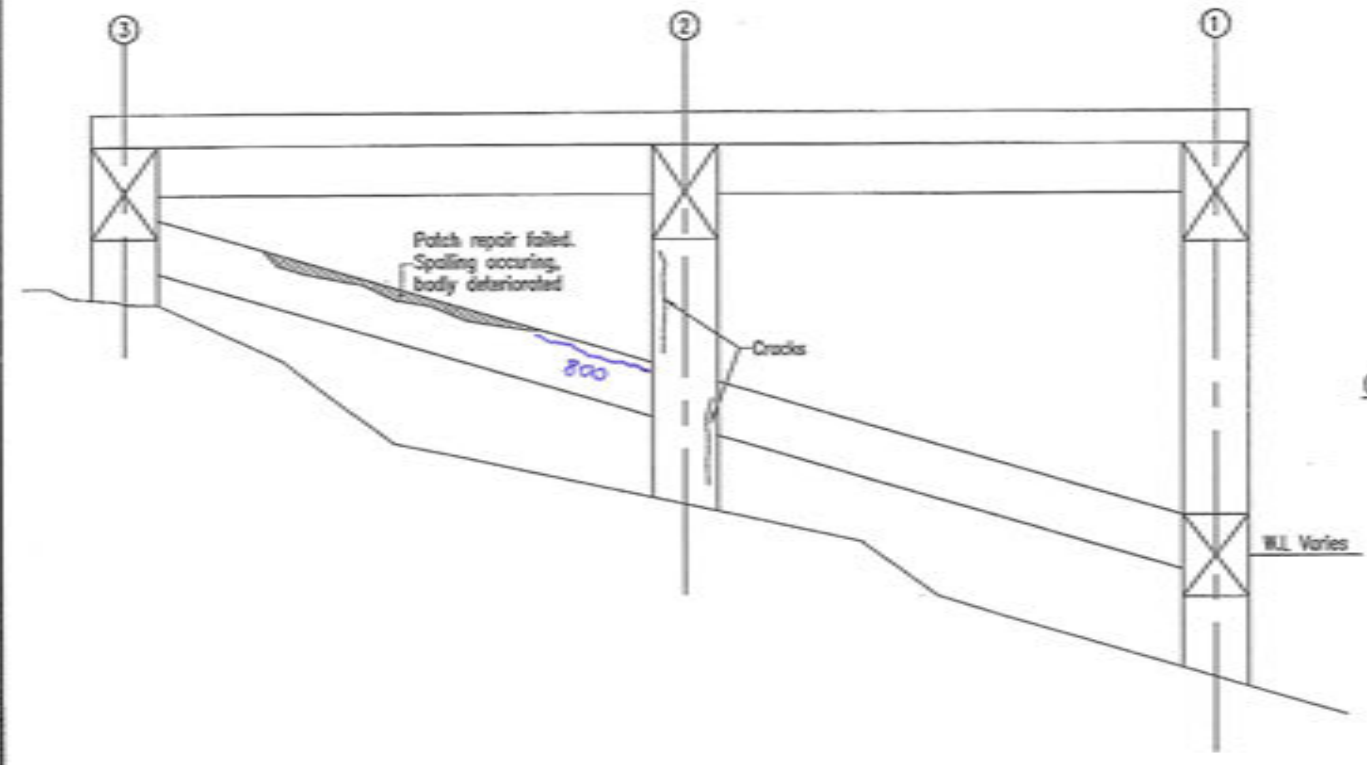

GRID ELEVATION - B11
Scale 1:25(A1)

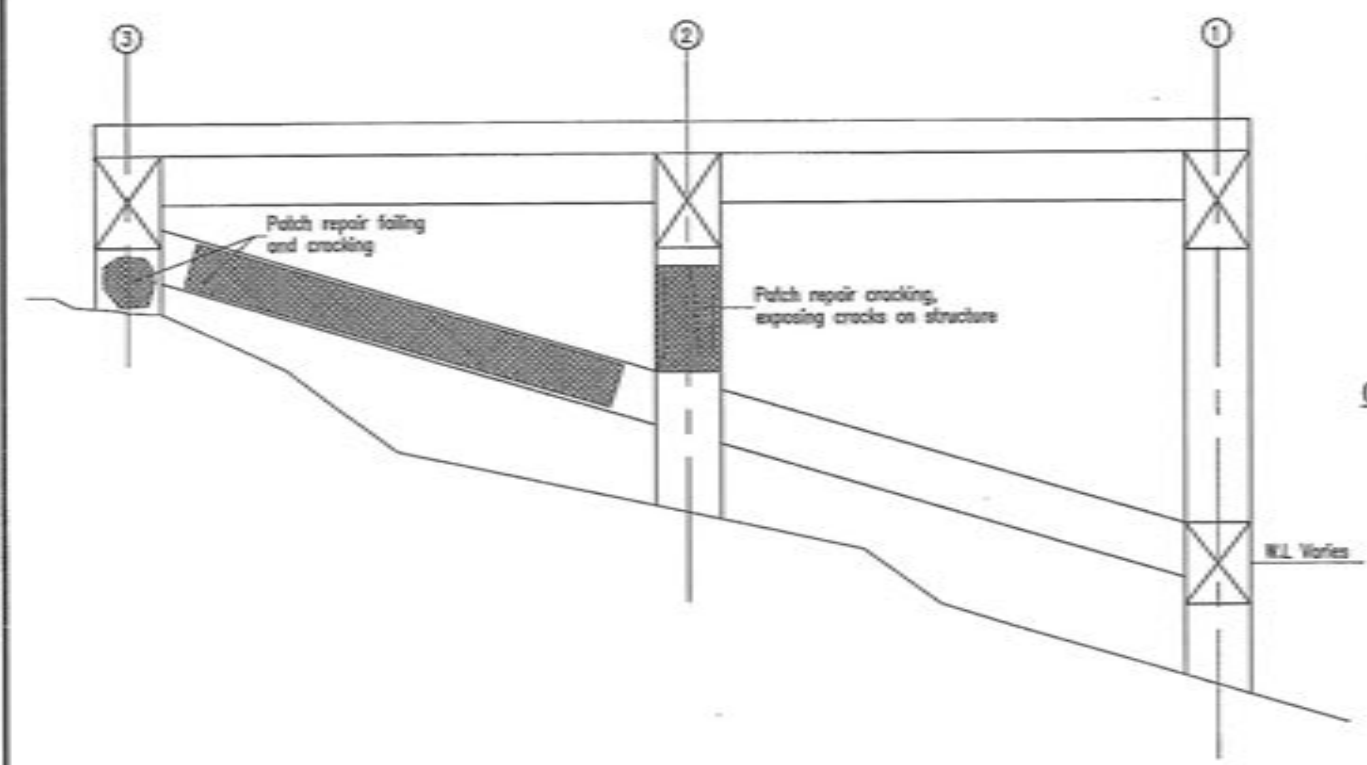
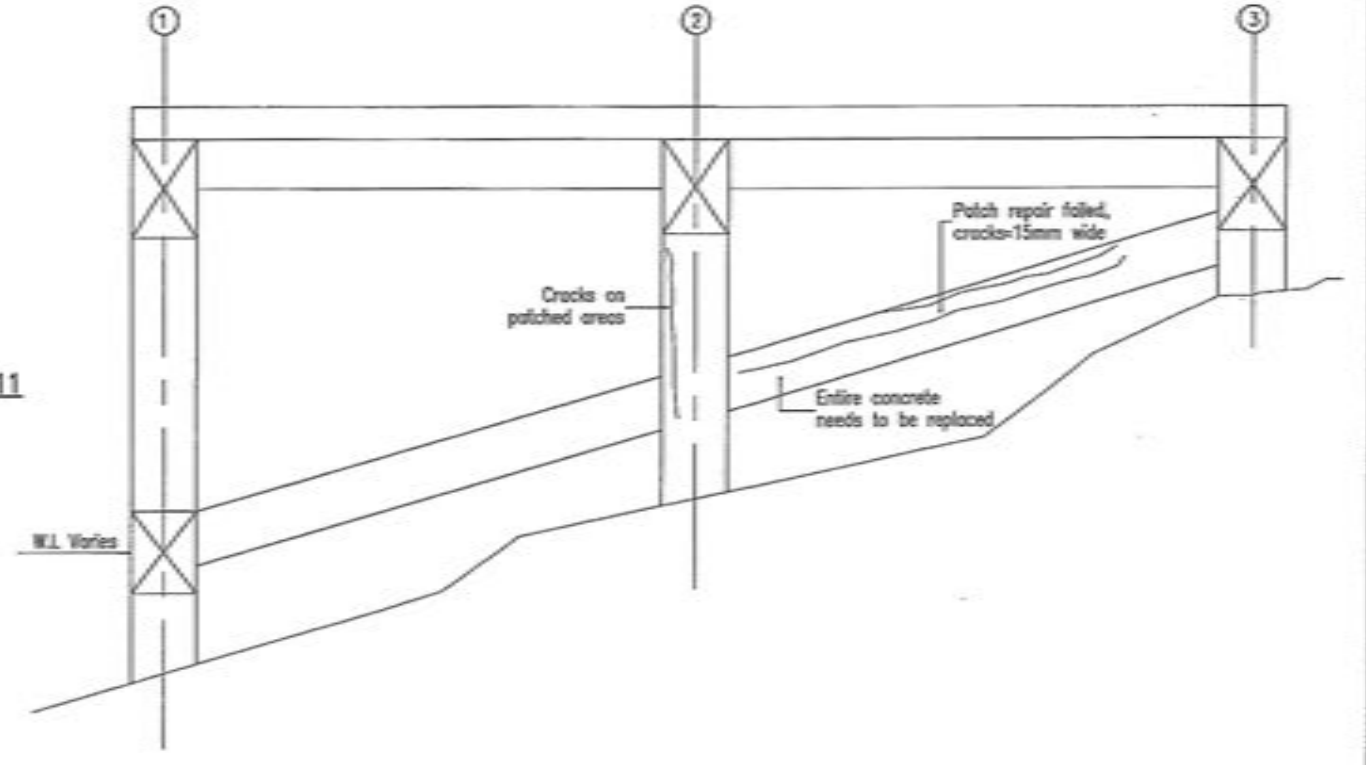

GRID ELEVATION - B12
Scale 1:25(A1)

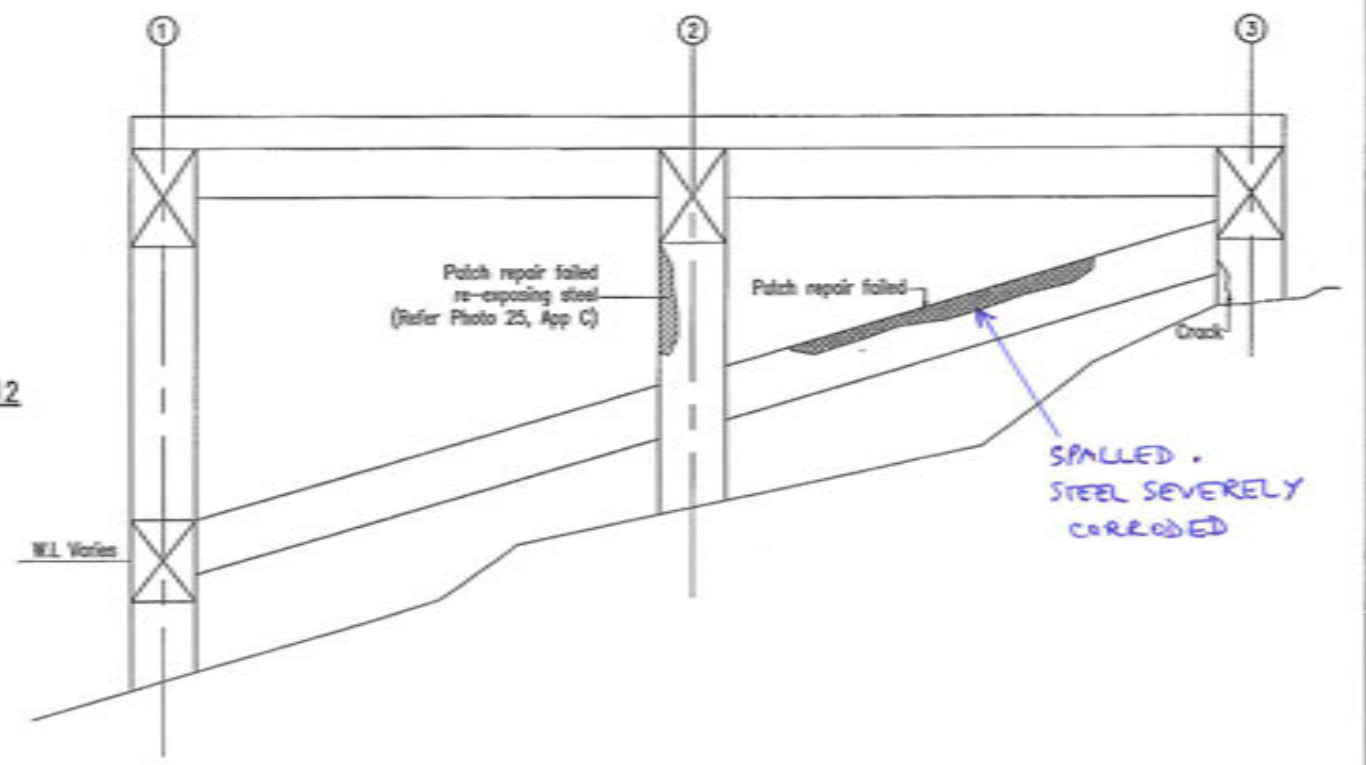

LEGEND

- Void in concrete
- Spalling of concrete
- Patch repair failure

NO.	BY	CHECKED	DATE
DESIGN			
DRAWN	K.Polyn	S.Nor	March 2008
APPROVED			
This drawing and its contents are the property of Opus International Consultants Limited. Any unauthorised employment or reproduction, in full or in part, is forbidden.			



Hamilton Office
 Photo By 3057
 Hamilton, New Zealand
 Tel: +64 7 839 8244
 Fax: +64 7 839 8244

FILE WHAKATANE DISTRICT COUNCIL WHAKATANE WHARF : INSPECTION WHAKATANE			
1940 SECTION GRID ELEVATIONS B11-B12			
STATUS	DRAFT	FILE	298081.04
SCALE	PLAT SIZE	FEATURE EDITOR	CODE SHEET REVISION
AS SHOWN	14/03/08 @ 10:44	2/214/177	2204 12 RD

25/03/2008 B11B

GRAPHIC SCALES 1:25 0 40 80 120 160 200 240 mm

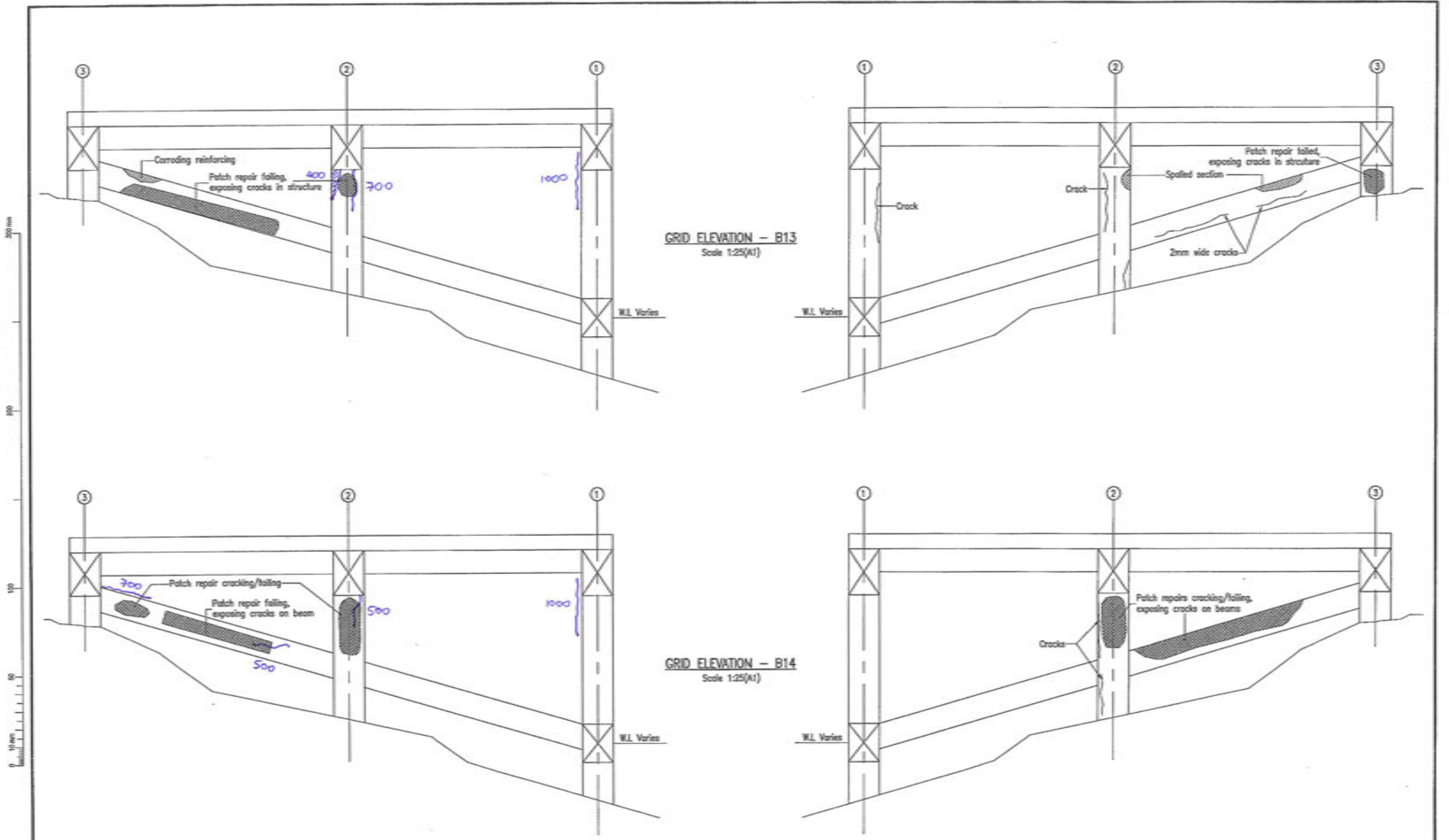

LEGEND

-  Void in concrete
-  Spalling of concrete
-  Patch repair failure

NO	BY	CHECKED	DATE
DESIGN			
DRAWN	KP/yn	D.M.R.	March 2008
APPROVED			
REVISION			
DATE			



Hamilton Office

Printed By 3057
 Hamilton, New Zealand

OPUS

Tel: +64 7 838 8244
 Fax: +64 7 838 8224

FILE: WHAKATANE DISTRICT COUNCIL WHAKATANE WHARF : INSPECTION WHAKATANE			
1940 SECTION GRID ELEVATIONS B13-B14			
DRIFT	FILE	288081.04	
SCALE	PLUF DATE	FEATURE NUMBER	CODE SHEET REVISION
AS SHOWN	14/03/08 @ 10:44	2/214/177	2204 13 RO

25/03/2008 9:15

0 10 mm
100 200 300 400 mm

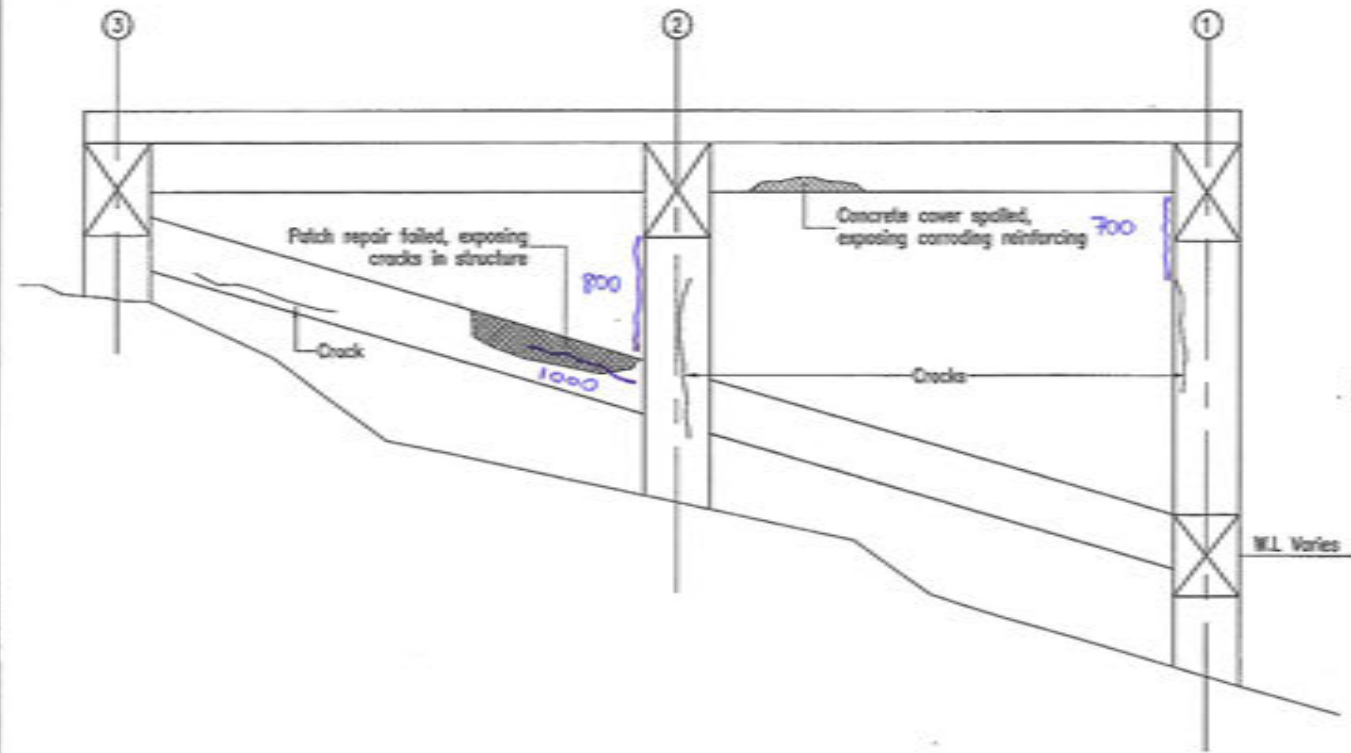

GRID ELEVATION - B15
Scale 1:25(A1)

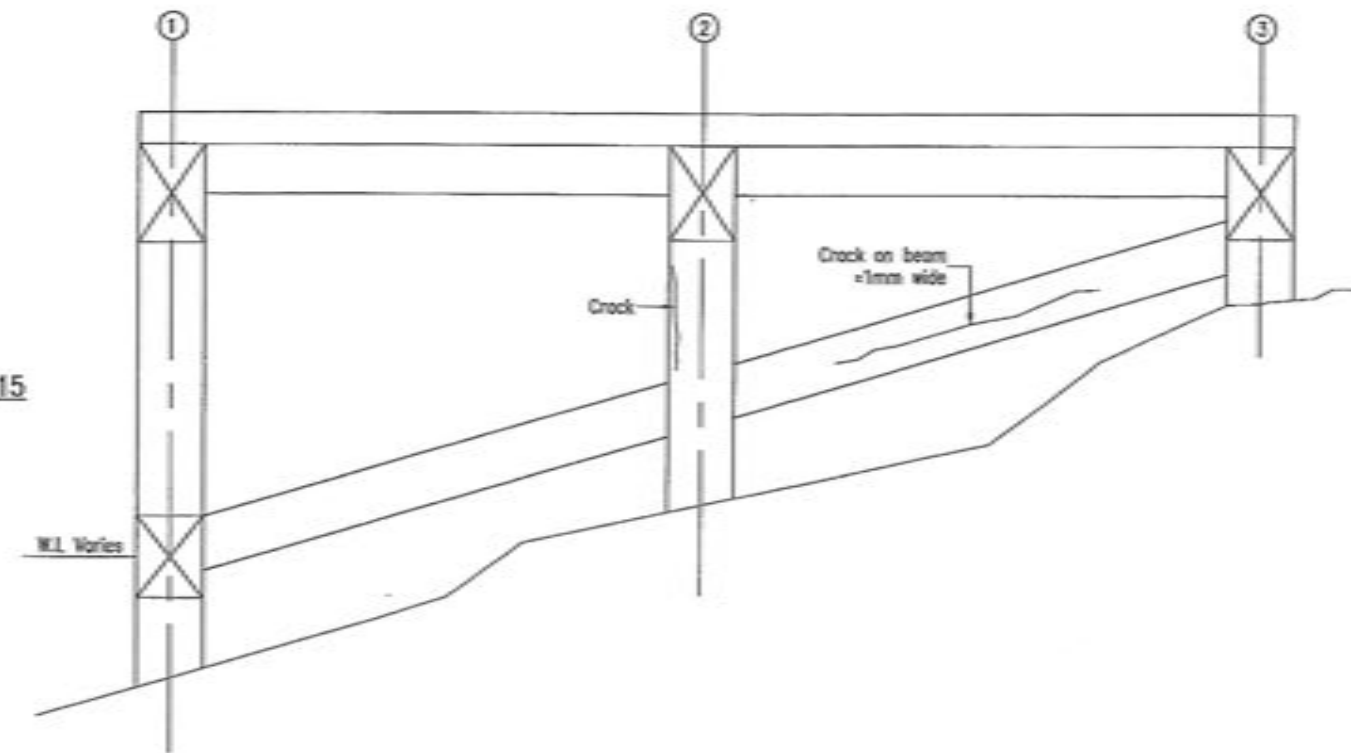

LEGEND

-  Void in concrete
-  Spalling of concrete
-  Patch repair failure

NO	BY	CHECKED	DATE
DESIGN			
DRAWN	N.Poly	E.Nor	March 2008
APPROVED			
ISSUED			
REV'D			
DATE			

This drawing and its contents are the property of Opus International Consultants Limited. Any unauthorised employment or reproduction, in full or in part, is forbidden.



Hamilton Office

Private Bag 3057
Hamilton, New Zealand

Tel: +64 7 838 8384
Fax: +64 7 838 8324

OPUS

FILE WHAKATANE DISTRICT COUNCIL WHAKATANE WHARF : INSPECTION WHAKATANE			
1940 SECTION GRID ELEVATION B15			
STATUS	DRAFT	FILE	288081.04
SCALE	AS SHOWN	PRINT DATE	14/03/08 @ 10:44
ISSUANCE NUMBER	2/214/177	CODE	2204
SHEET	14	REVISION	RO

18/03/2008 8:19

GRAPHIC SCALES 1:25 0 400 800 1200 1600 2000 2400 mm

g:\288008\008104_1900\whakatane wharf\pand\2_214_177_2204_7-18.dwg - 1400 ORIGINAL SHEET SIZE A1 [A4x594]

300mm
200
100
0 10mm

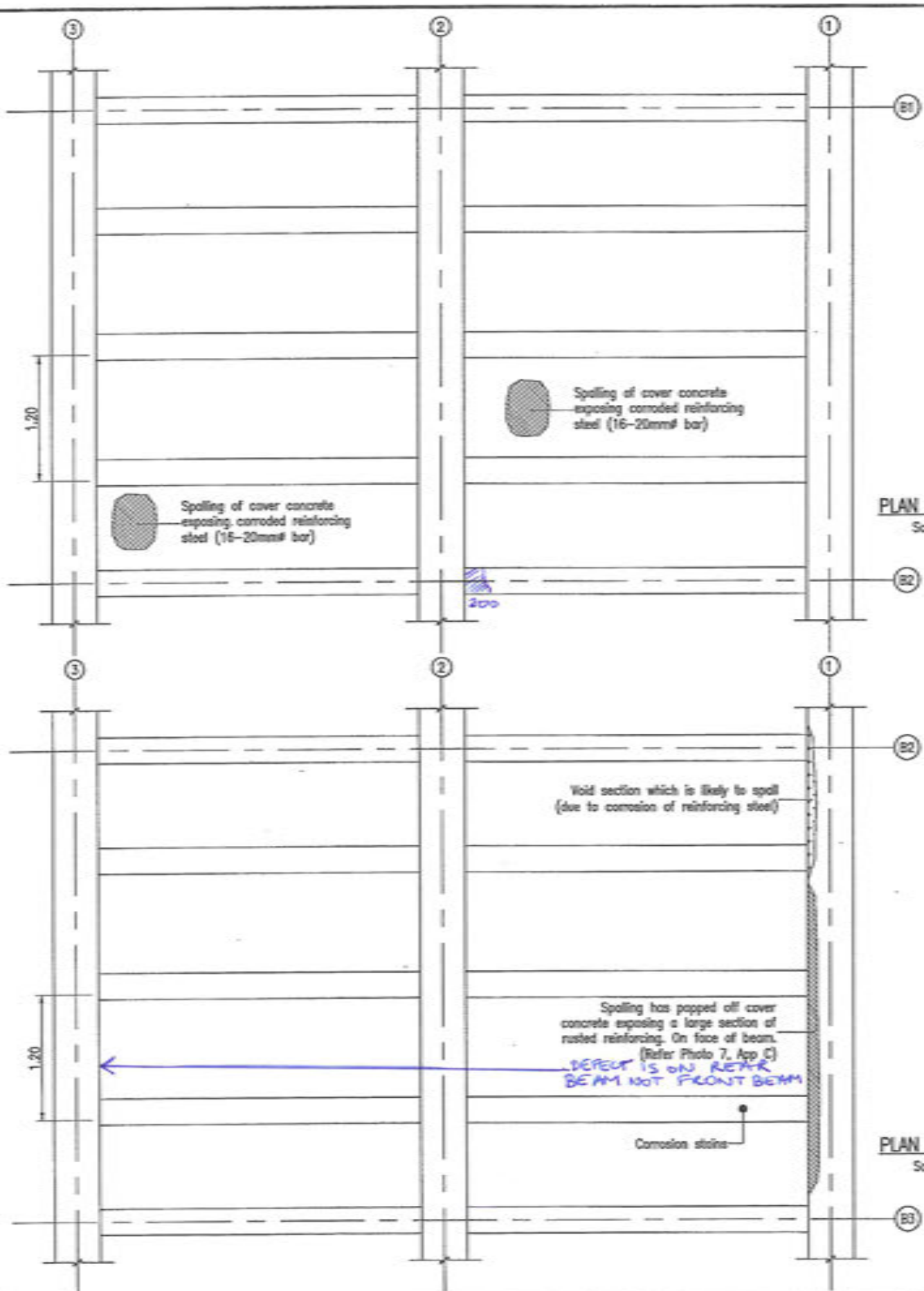

PLAN - B1 to B2
Scale 1:25(A1)

PLAN - B2 to B3
Scale 1:25(A1)

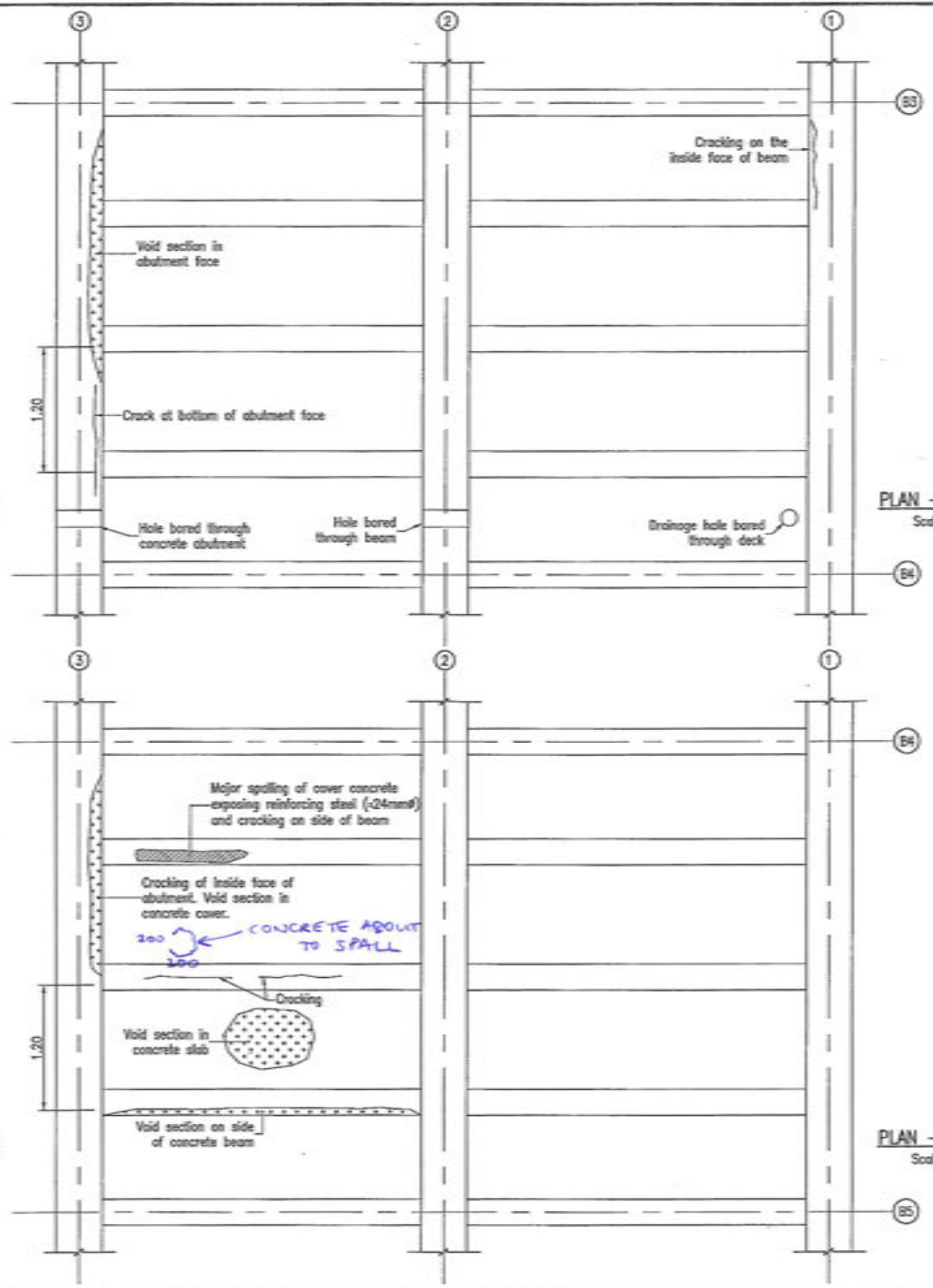

PLAN - B3 to B4
Scale 1:25(A1)

PLAN - B4 to B5
Scale 1:25(A1)

LEGEND

	Void in concrete
	Spalling of concrete
	Patch repair failure

DESIGN	BY	CHECKED	DATE
	KPhlyn	D.Sie	March 2008
APPROVED			

This drawing and its contents are the property of Opus International Consultants Limited. Any unauthorised employment or reproduction, in full or in part, is forbidden.



Hamilton Office

OPUS

Private Bag 3057
Hamilton, New Zealand
Tel: +64 7 838 8344
Fax: +64 7 838 8324

REF: WHAKATANE DISTRICT COUNCIL WHAKATANE WHARF - INSPECTION WHAKATANE			
1940 SECTION PLAN BETWEEN GRIDS B1/2, B2/3, B3/4, B4/5			
SCALE	DRAFT	REV	288081.04
AS SHOWN	PLSIF DATE 14/03/08 @ 10:44	FEATURE IDENTIFIER 2/214/177	CODE SHEET REVISION 2204 15 R0

25/03/2008 8:10

GRAPHIC SCALES 1:25 0 400 800 1200 1600 2000 2400 mm

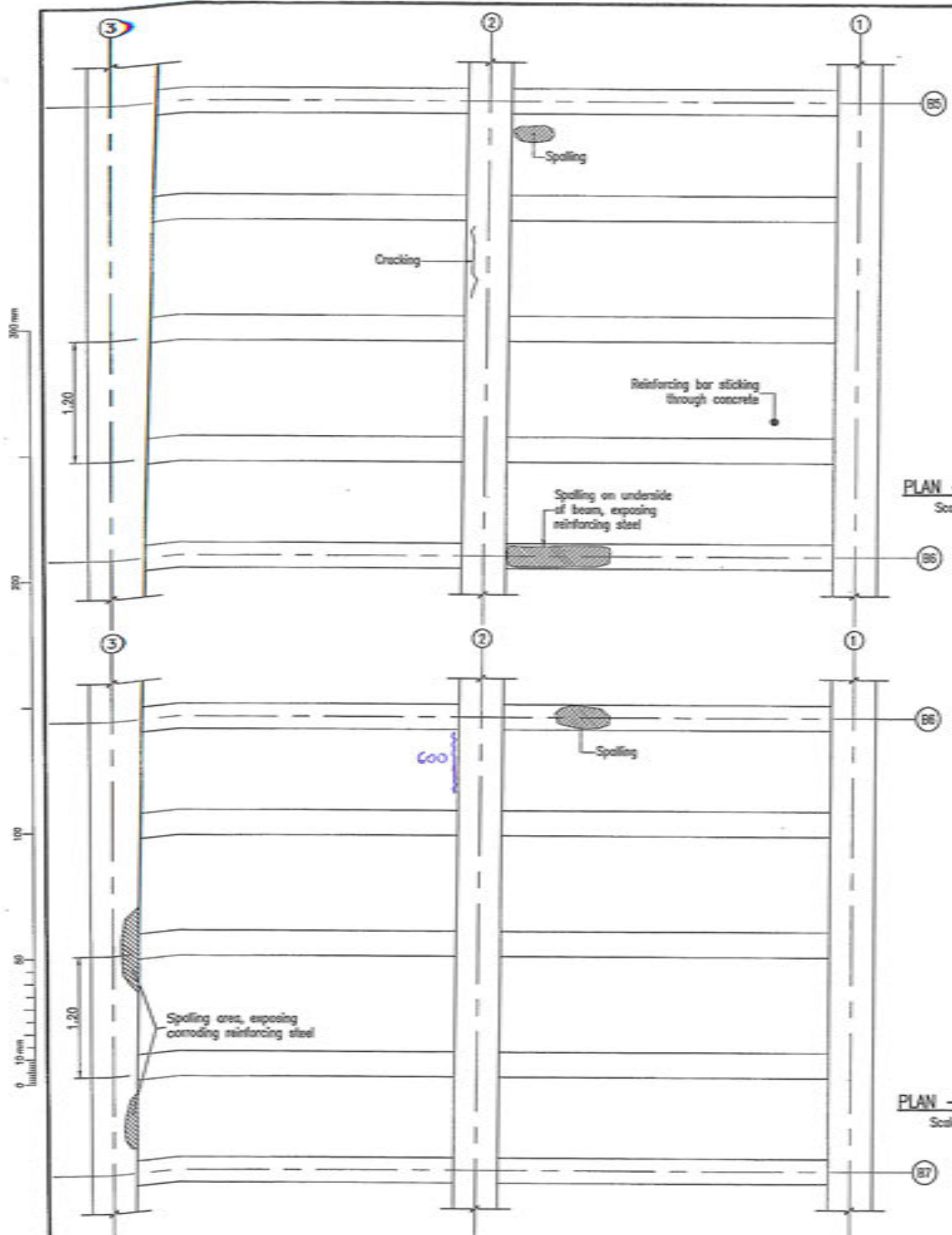

PLAN - B5 to B6
Scale 1:25(A1)

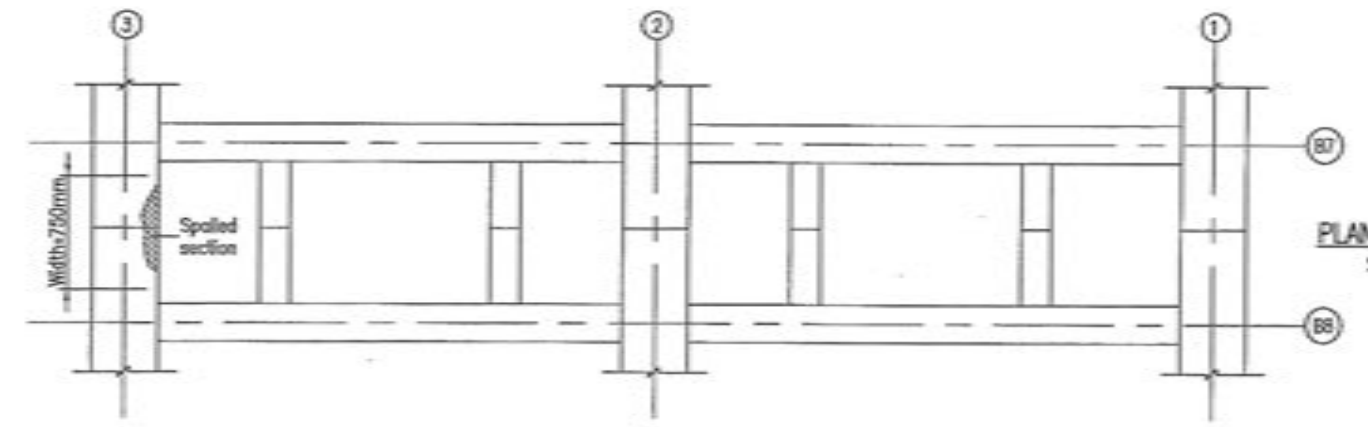

PLAN - B7 to B8
Scale 1:25(A1)

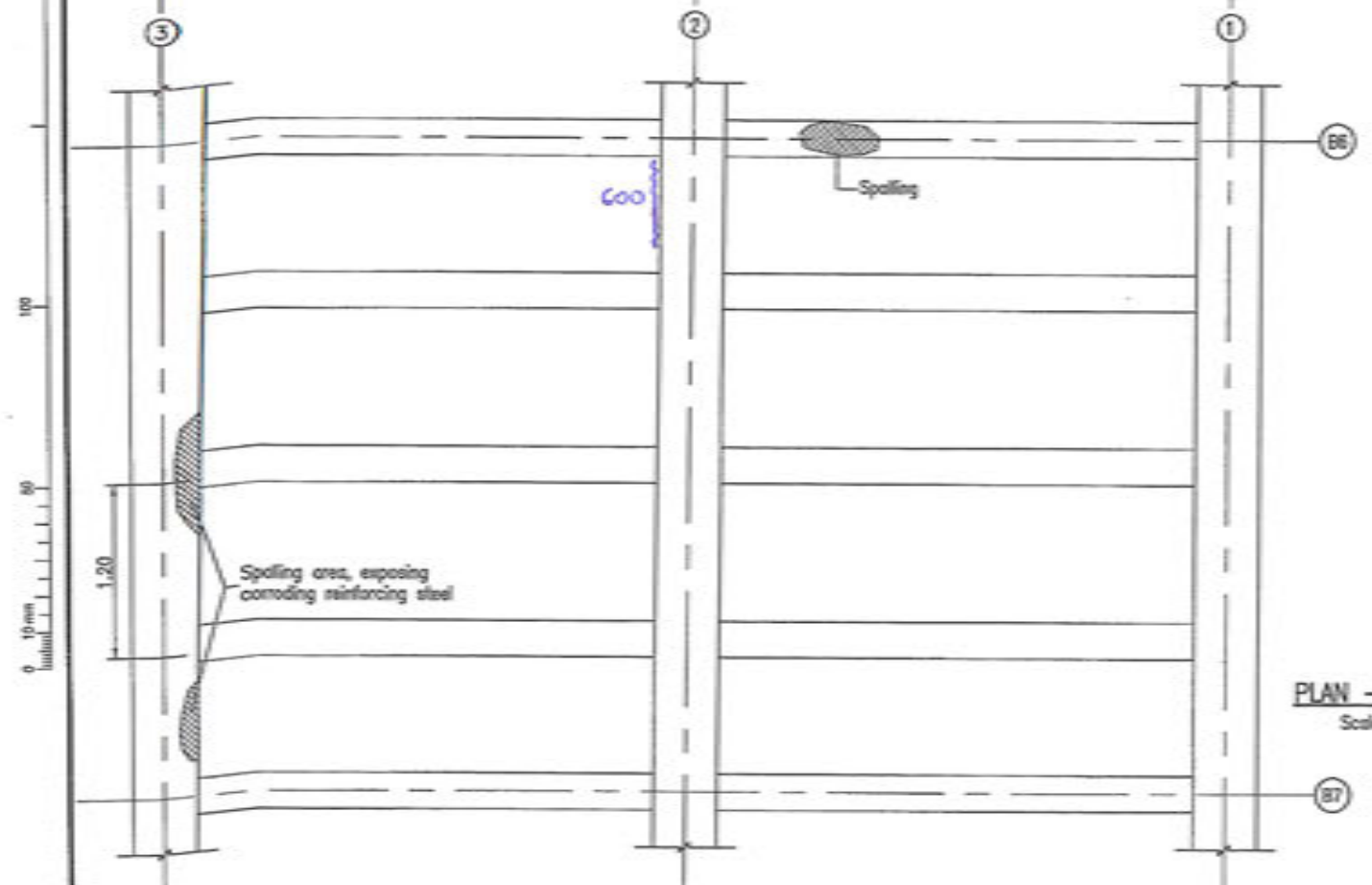

PLAN - B6 to B7
Scale 1:25(A1)

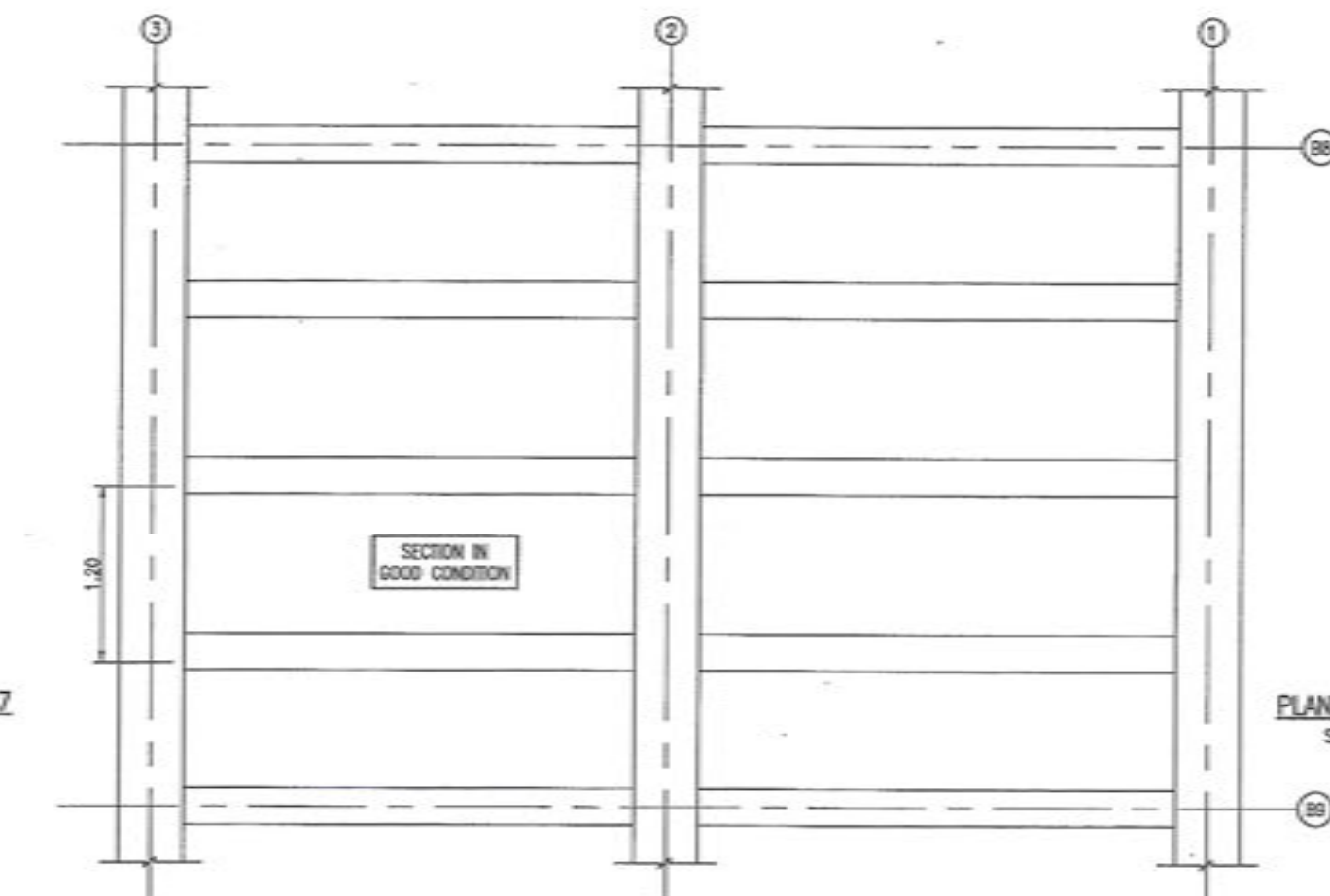

PLAN - B8 to B9
Scale 1:25(A1)

LEGEND

	Void in concrete
	Spalling of concrete
	Patch repair failure

NO	BY	CHECKED	DATE
DESIGN			
DRAWN	K.Polya	S.Olar	March 2008
APPROVED			
This drawing and its contents are the property of Opus International Consultants Limited. Any unauthorised employment or reproduction, in full or in part, is forbidden.			
AMENDED	APPROVED	DATE	



Hamilton Office

OPUS

Private Bag 3037
Hamilton, New Zealand
Tel: +64 7 838 8341
Fax: +64 7 838 8324

TITLE: WAIKATANE DISTRICT COUNCIL WAIKATANE WHARF - INSPECTION WAIKATANE					
1940 SECTION PLAN BETWEEN GRIDS B5/6, B6/7, B7/8, B8/9					
STATUS	DRAFT	FILE	288081.04		
SCALE	AS SHOWN	PLANT DATE	14/03/08 @ 10:44	FIGURE NUMBER	2/214/177
		CODE	2204	SHEET	16
		REVISION			RO

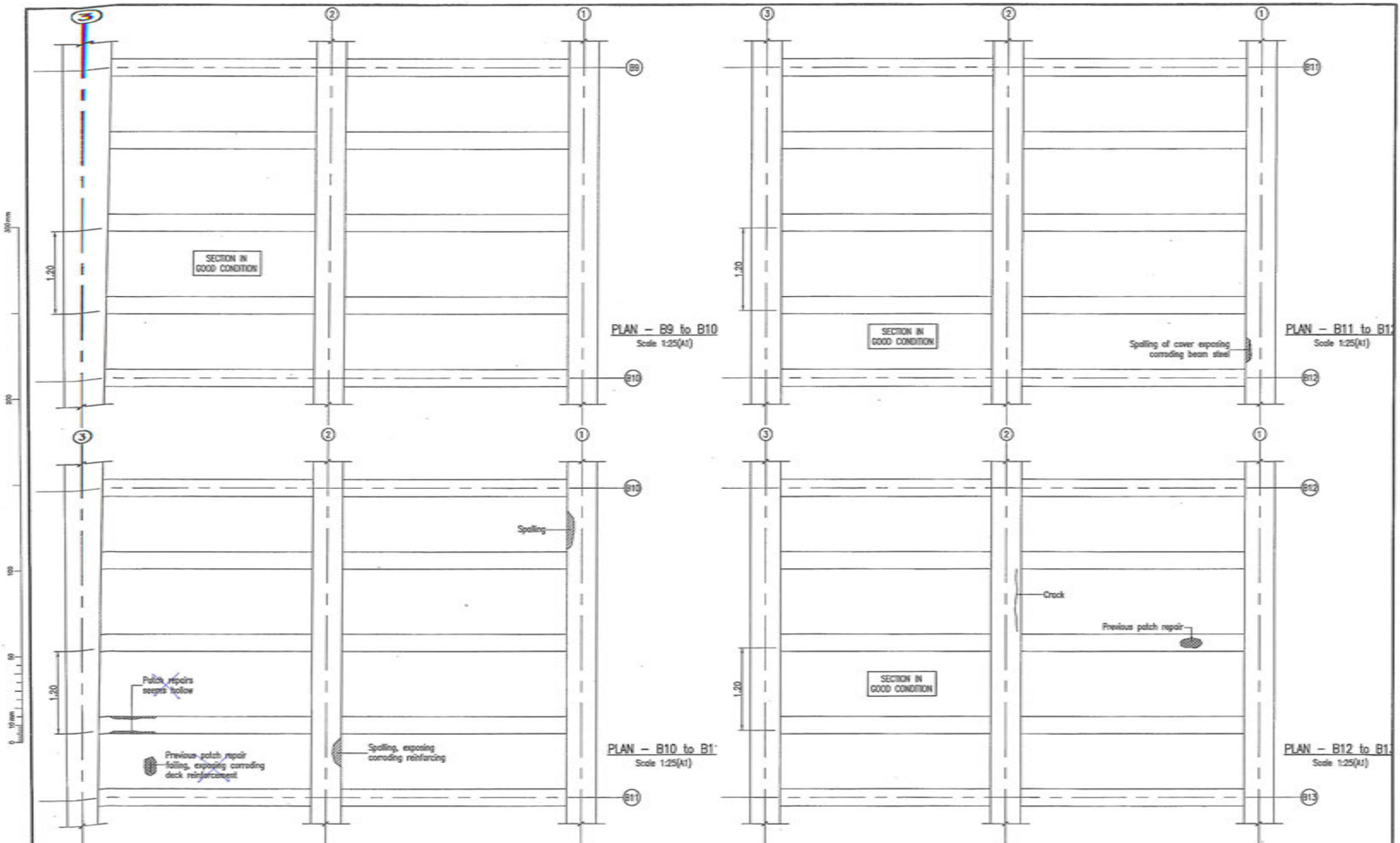

20/03/2008 B10

GRAPHIC SCALE 1:25

0 100 200 300 mm

LEGEND

- Void in concrete
- Spalling of concrete
- Patch repair failure

NO.	REVISED	BY	CHECKED	DATE
		DESIGN		
		DRAWN		
		APPROVED		
		This drawing and its contents are the property of Opus International Consultants Limited. Any unauthorised employment or reproduction, in full or in part, is forbidden.		
APPROVED		DATE		



OPUS

Hamilton Office

Private Bag 3057
Hamilton, New Zealand

Tel: +64 7 838 8344
Fax: +64 7 838 8324

FILE WHAKATANE DISTRICT COUNCIL WHAKATANE WHARF : INSPECTION WHAKATANE			
1940 SECTION PLAN BETWEEN GRIDS B9/10,B10/11,B11/12,B12/13			
STATUS	DRAFT	FILE	288081.04
SCALE	AS SHOWN	PLUT DATE	14/03/08 @ 10:44
		ISSUANCE NUMBER	2/214/177
		CODE	2204
		SHEET	17
		REGION	RO

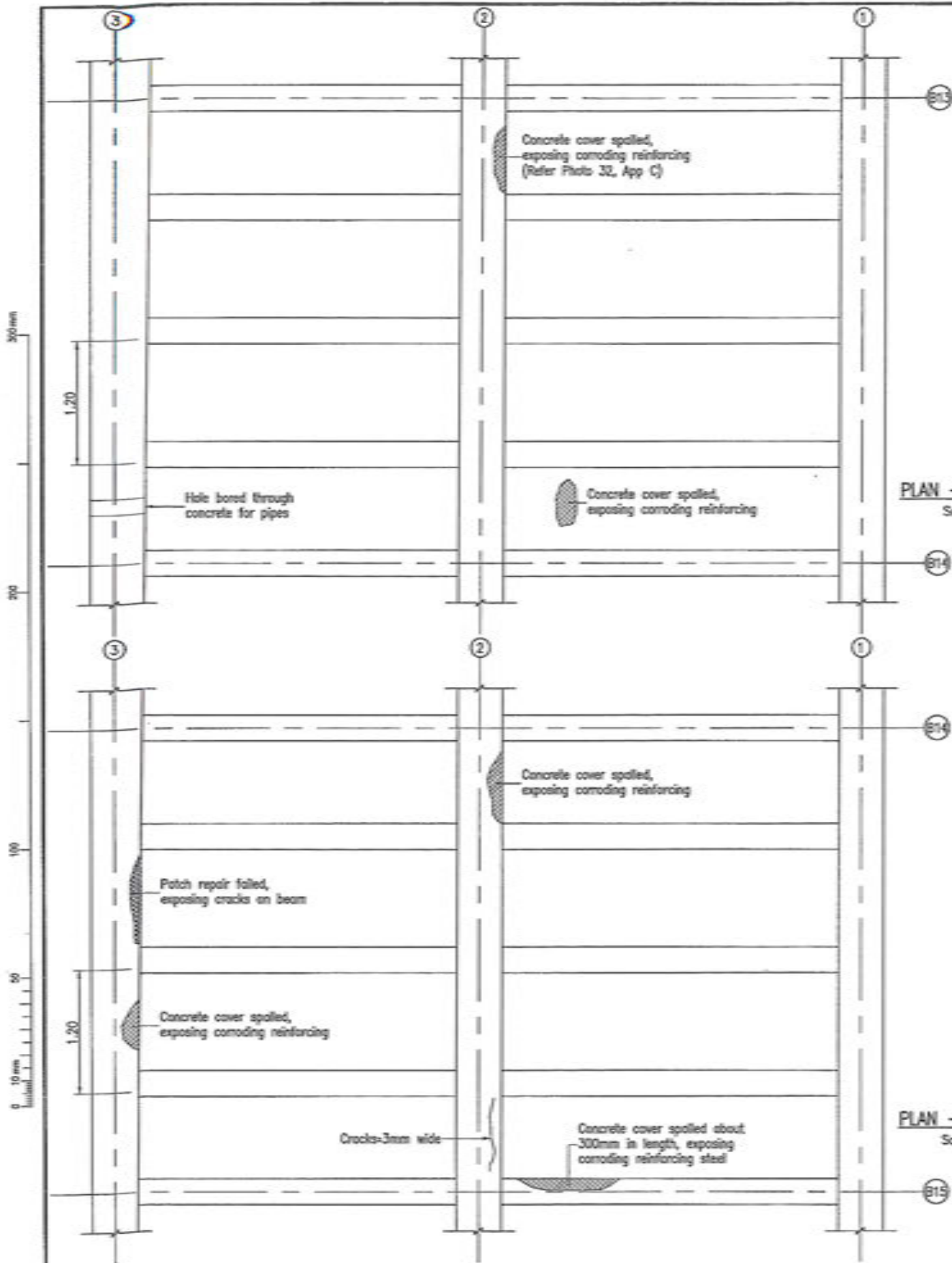

PLAN - B13 to B14
Scale 1:25(A1)

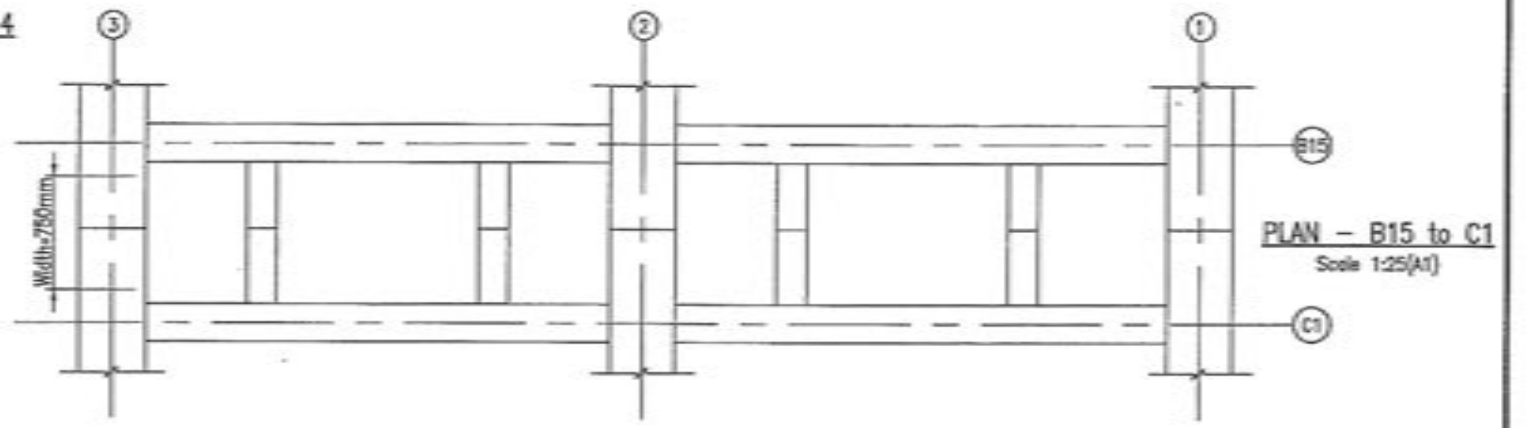

PLAN - B15 to C1
Scale 1:25(A1)

LEGEND

	Void in concrete
	Spalling of concrete
	Patch repair failure

NO	BY	CHECKED	DATE
0001	K.Polya	S.Har	March 2008
APPROVED			
This drawing and its contents are the property of Opus International Consultants Limited. Any unauthorised employment or reproduction, in full or in part, is prohibited.			
AMENDMENT	APPD	DATE	



Hamilton Office

OPUS

Private Bay 3057
Whakatane, New Zealand
Tel: +64 7 838 8244
Fax: +64 7 838 8224

FILE WHAKATANE DISTRICT COUNCIL WHAKATANE WHARF : INSPECTION WHAKATANE					
1940 SECTION PLAN BETWEEN GRIDS B13/14, B14/15, B15/C1					
SCALE	DRAFT	FILE	288081.04		
AS SHOWN	PLOT DATE	REVISION NUMBER	CODE	SHEET	REVISION
	14/03/08 @ 10:44	2/214/177	2204	18	RO

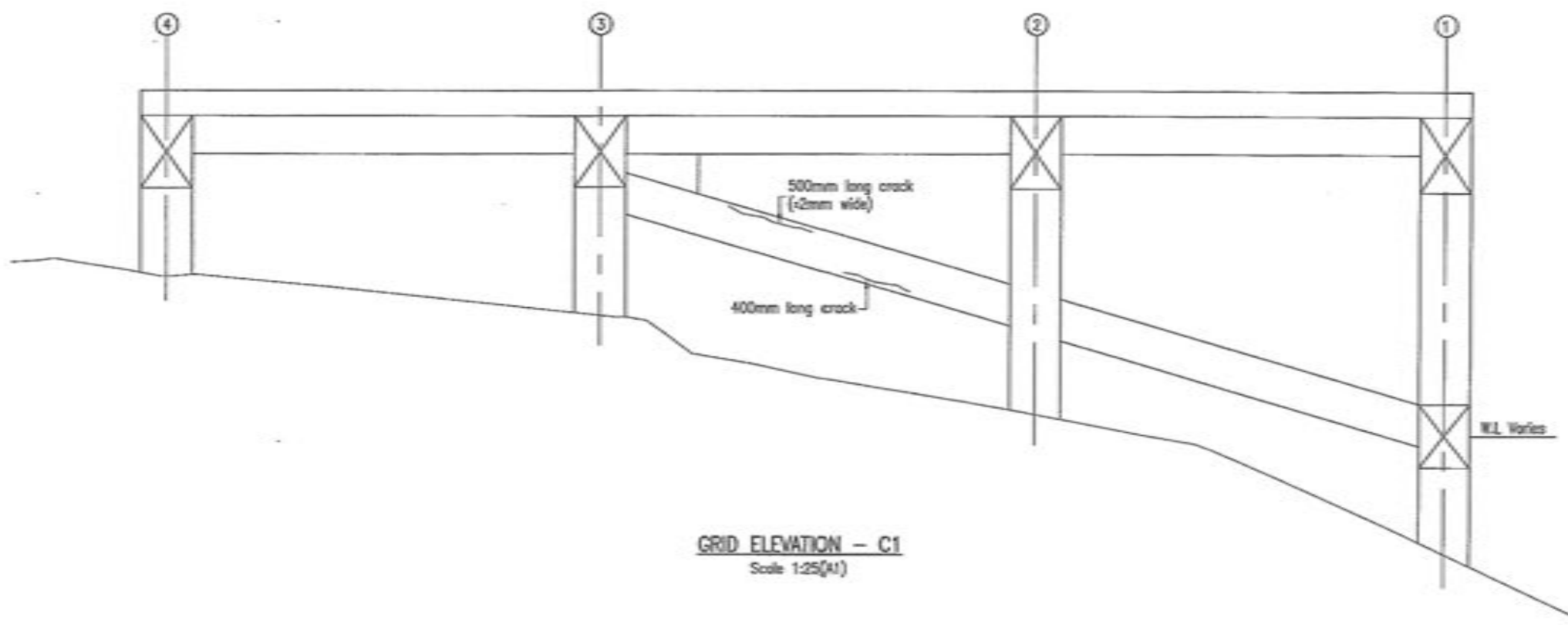

GRID ELEVATION - C1
Scale 1:25(A1)

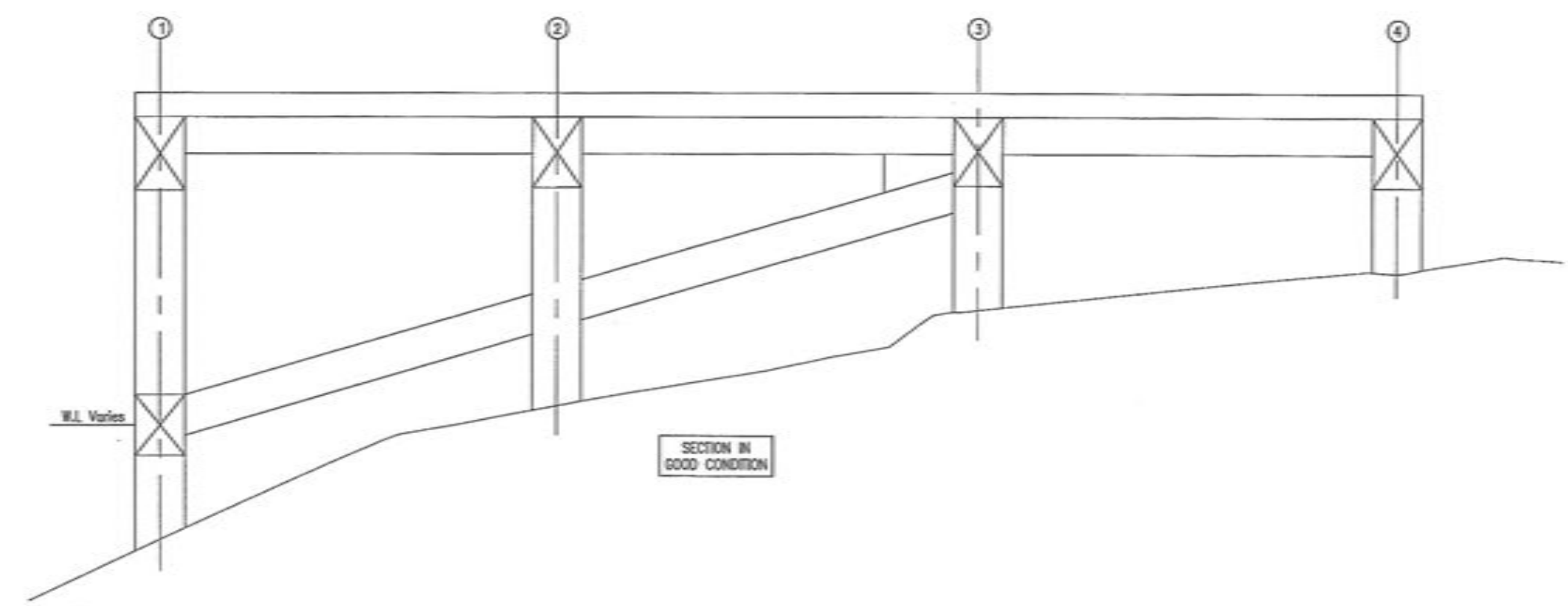

SECTION IN GOOD CONDITION

0 50 100 200 300 mm

LEGEND

	Void in concrete
	Spalling of concrete
	Patch repair failure

NO.	BY	CHECKED	DATE
DESIGN			
DRAWN	K.Palyn	S.Kor	March 2008
APPROVED			
REVISION			

This drawing and its contents are the property of Opus International Consultants Limited. Any unauthorised employment or reproduction, in full or in part, is forbidden.



Hamilton Office

OPUS

Private Bay 357
Whakatane, New Zealand
Tel: +64 7 838 8346
Fax: +64 7 838 8324

FILE WHAKATANE DISTRICT COUNCIL WHAKATANE WHARF : INSPECTION WHAKATANE			
1919 SECTION GRID ELEVATIONS C1			
STATUS	DRAFT	FILE	258081.04
SCALE	AS SHOWN	PLANT DATE	14/03/08 @ 10:44
FEATURE NUMBER	2/214/177	CODE	2204
SHEET	19	REVISION	RD

24/03/2008 11:14

GRAPHIC SCALE 1:25 0 40 80 120 160 200 240 mm

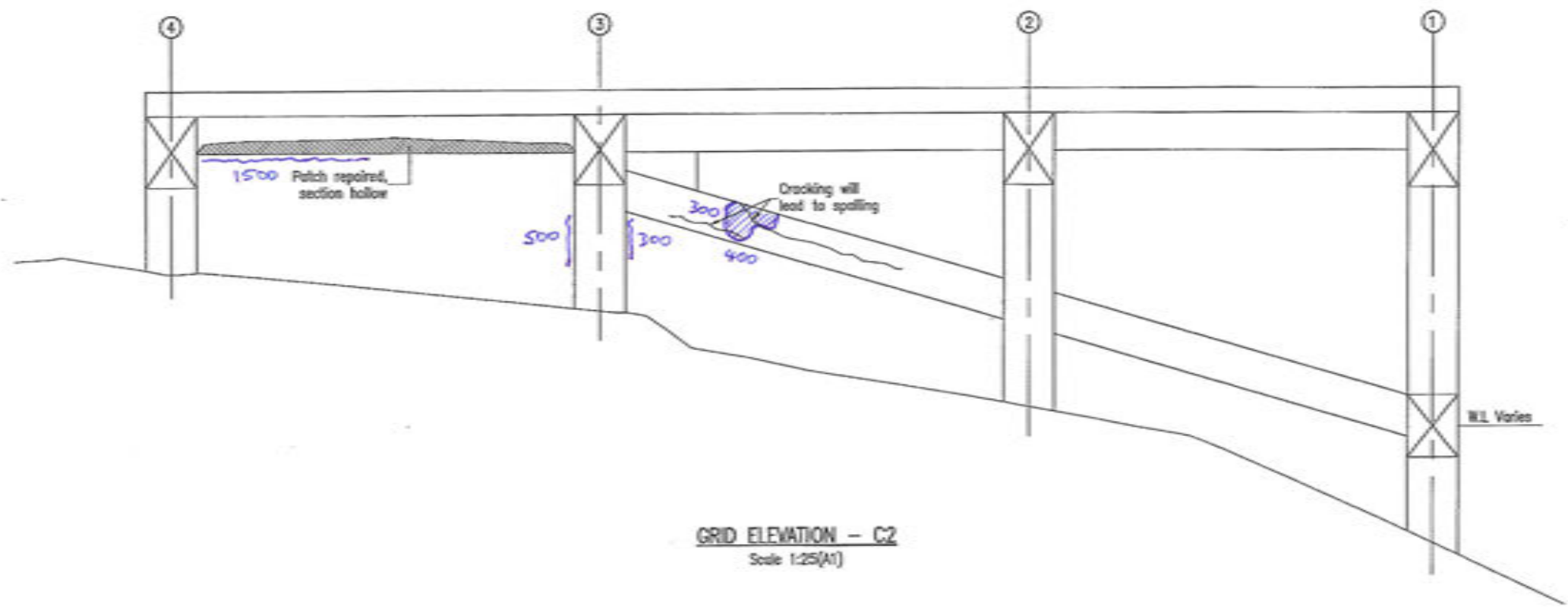

GRID ELEVATION - C2
Scale 1:25(A1)

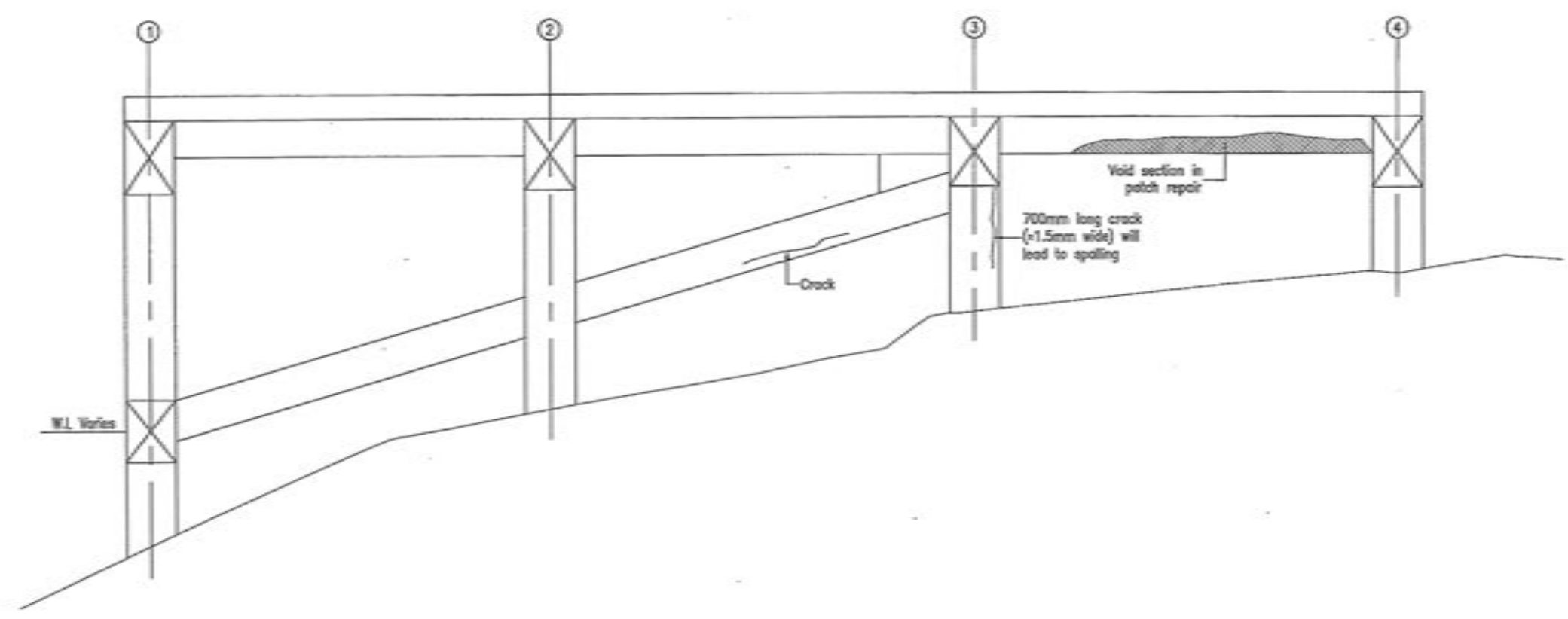

0 10 mm 50 100 200 300 mm

LEGEND

	Void in concrete
	Spalling of concrete
	Patch repair failure

AMENDMENT	APP'D	DATE	BY	CHECKED	DATE
			DESIGN		
			DRAWN	NP/lyn	01/01/2008
			APPROVED		

This drawing and its contents are the property of Opus International Consultants Limited. Any unauthorised employment or reproduction, in full or in part, is forbidden.



Hamilton Office

Private Bag 2007
Hamilton, New Zealand

OPUS

Tel: +64 7 838 8341
Fax: +64 7 838 8324

PROJECT: WHAKATANE DISTRICT COUNCIL WHAKATANE WHARF : INSPECTION WHAKATANE					
SECTION: 1919 SECTION GRID ELEVATIONS C2					
STATUS: DRAFT	FILE: 288081.04				
DATE: 14/03/08 @ 10:44	FEATURE IDENTIFIER: 2/214/177	CODE: 2204	SHEET: 20	REVISION: RD	

25/03/2008 11:14

GRAPHIC SCALE 1:25 0 400 800 1200 1600 2000 2400 mm

0 50 100 200 300mm

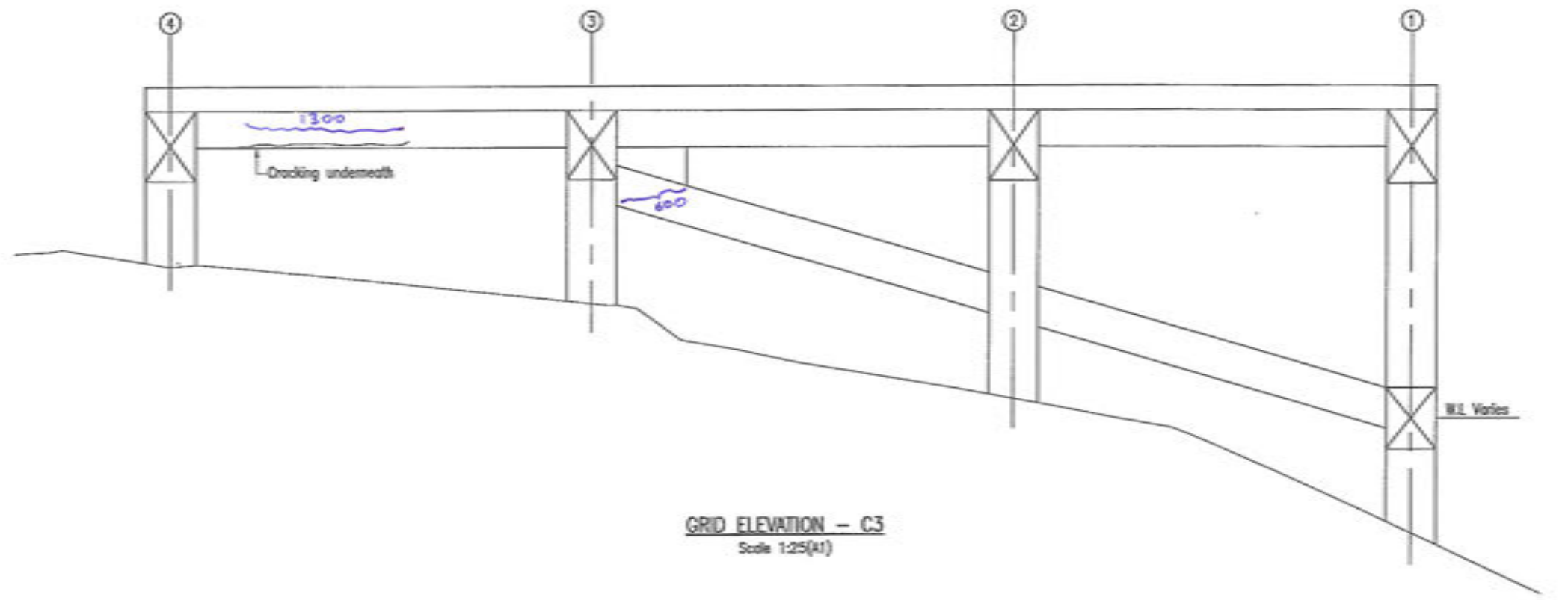

GRID ELEVATION - C3
Scale 1:25(A1)

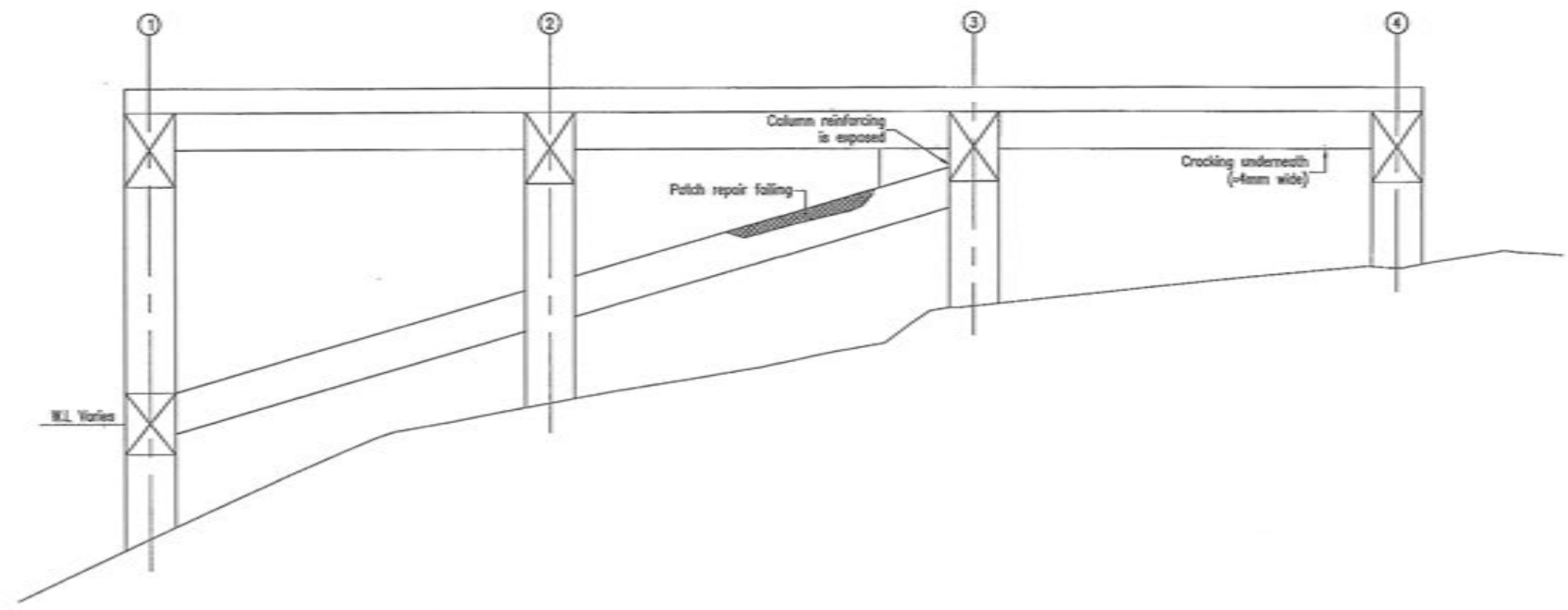

LEGEND

- Void in concrete
- Spalling of concrete
- Patch repair failure

REVISION	BY	CHECKED	DATE
	JCSM		
	DRWH	NR/PLN	2/10/08
APPROVED			
This drawing and its contents are the property of Opus International Consultants Limited. Any unauthorised employment or reproduction, in full or in part, is forbidden.			



Hamilton Office

OPUS

Phone 054 337
 Hamilton, New Zealand
 Fax: +64 7 838 824
 Fax: +64 7 838 824

REF: WHAKATANE DISTRICT COUNCIL WHAKATANE WHARF : INSPECTION WHAKATANE					
1919 SECTION GRID ELEVATIONS C3					
STATUS	DRAFT	FILE	288081.04		
SCALE	AS SHOWN	PLUT DATE	ISSUE NUMBER	CUSE	SHEET
		14/03/08 @ 10:44	2/214/177	2204	21
					RO

25/03/2008 11:14

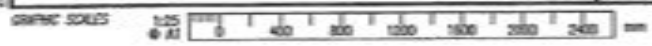

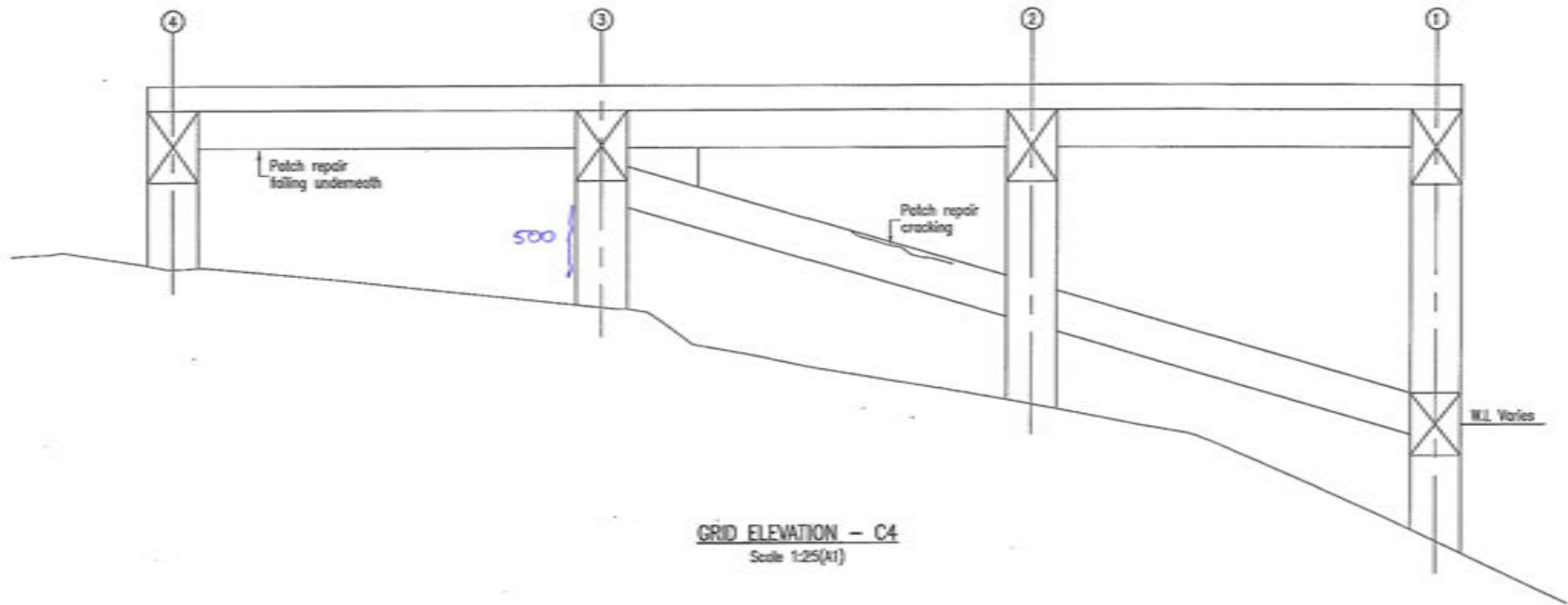

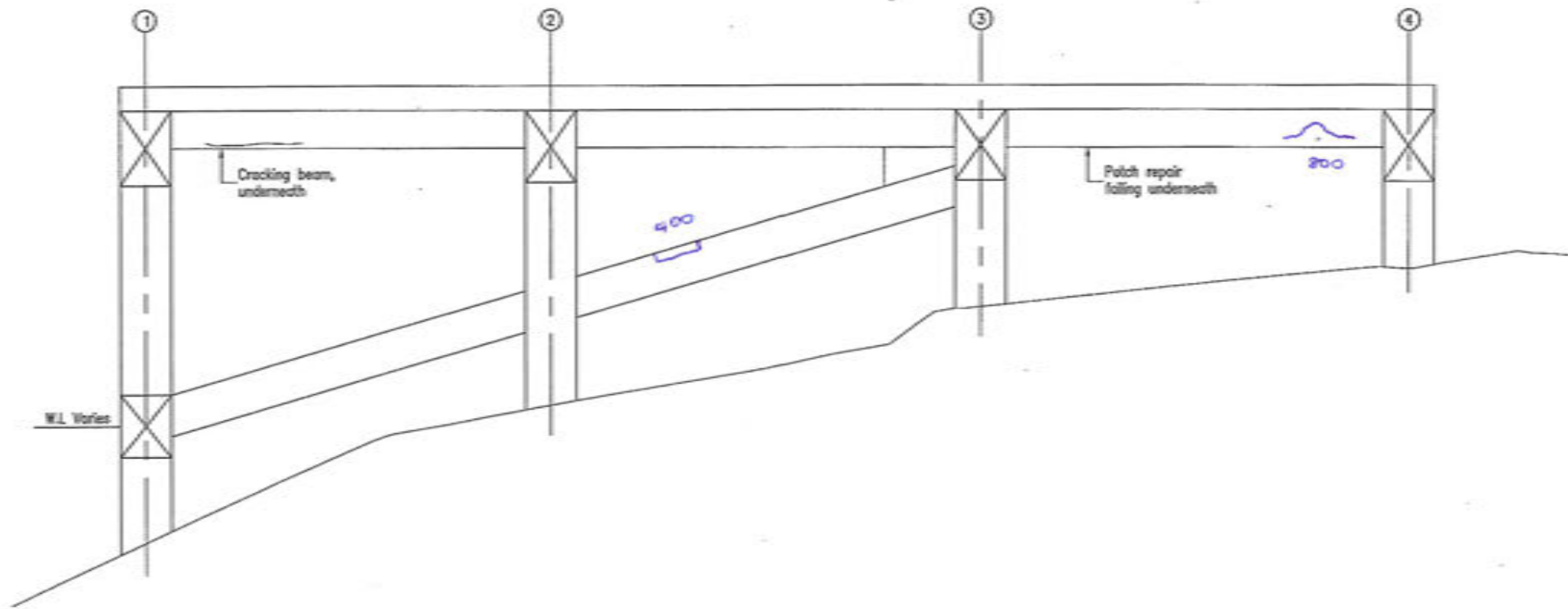

GRID ELEVATION - C4
Scale 1:25(A1)



300 mm
200
100
0 10 mm

LEGEND

-  Void in concrete
-  Spalling of concrete
-  Patch repair failure

NO.	BY	CHECKED	DATE
DESIGN			
DRAWN	N.Palyn	E.Har	March 2008
APPROVED			
REVISION			
APPROVED			
DATE			

This drawing and its contents are the property of Opus International Consultants Limited. Any unauthorized employment or reproduction, in full or in part, is forbidden.



Hamilton Office
 Private Bag 2057
 Hamilton, New Zealand
 Tel: +64 7 839 8244
 Fax: +64 7 839 8244

FILE WHAKATANE DISTRICT COUNCIL WHAKATANE WHARF : INSPECTION WHAKATANE			
1919 SECTION GRID ELEVATIONS C4			
STATUS	DRAFT	FILE	288081.04
SCALE	AS SHOWN	PLUT DATE	14/03/08 @ 10:44
FEATURE NUMBER	2/214/177	CUBE	2204
SHEET	22	REGION	RO

20/03/2008 11:14



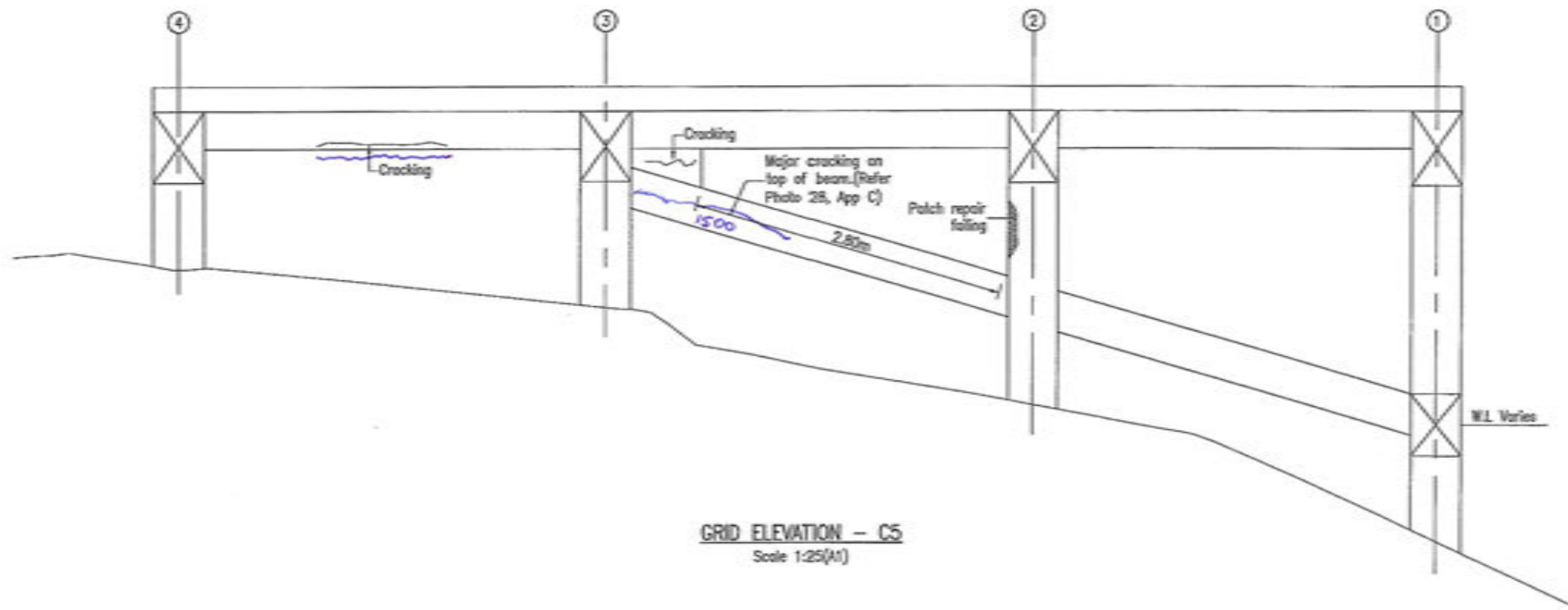

GRID ELEVATION - C5
Scale 1:25(A1)

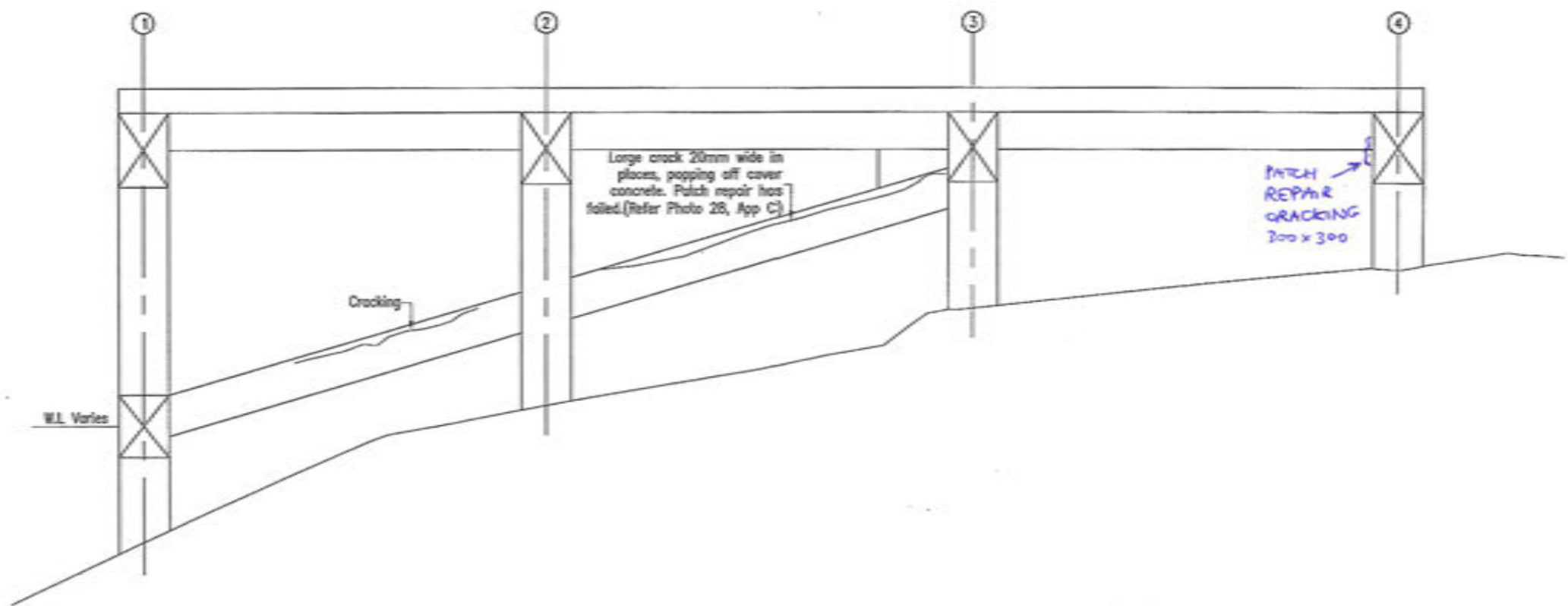

0 10 20 30 40 50 60 70 80 90 100 110 120 130 140 150 160 170 180 190 200 210 220 230 240 250 260 270 280 290 300 mm

LEGEND

- Void in concrete
- Spalling of concrete
- Patch repair failure

NO.	BY	CHECKED	DATE
DESIGN			
DRAWN	N.Polye	S.Hob	March 2008
APPROVED			
REVISION	APPD	DATE	



Hamilton Office

OPUS

Private Bag 3057
Hamilton, New Zealand
Tel: +64 7 838 8344
Fax: +64 7 838 8324

REF: WYKATANE DISTRICT COUNCIL WYKATANE WHARF : INSPECTION WYKATANE			
1919 SECTION GRID ELEVATIONS C5			
STATUS	DRAFT	FILE	268061.04
SCALE	AS SHOWN	PLUT DATE	14/03/08 @ 10:44
		ISSUE NUMBER	2/214/177
		CODE	2204
		SHEET	23
		REVISION	RD

25/03/2008 11:14

GRAPHIC SCALES 1:25 0 40 80 120 160 200 240 mm

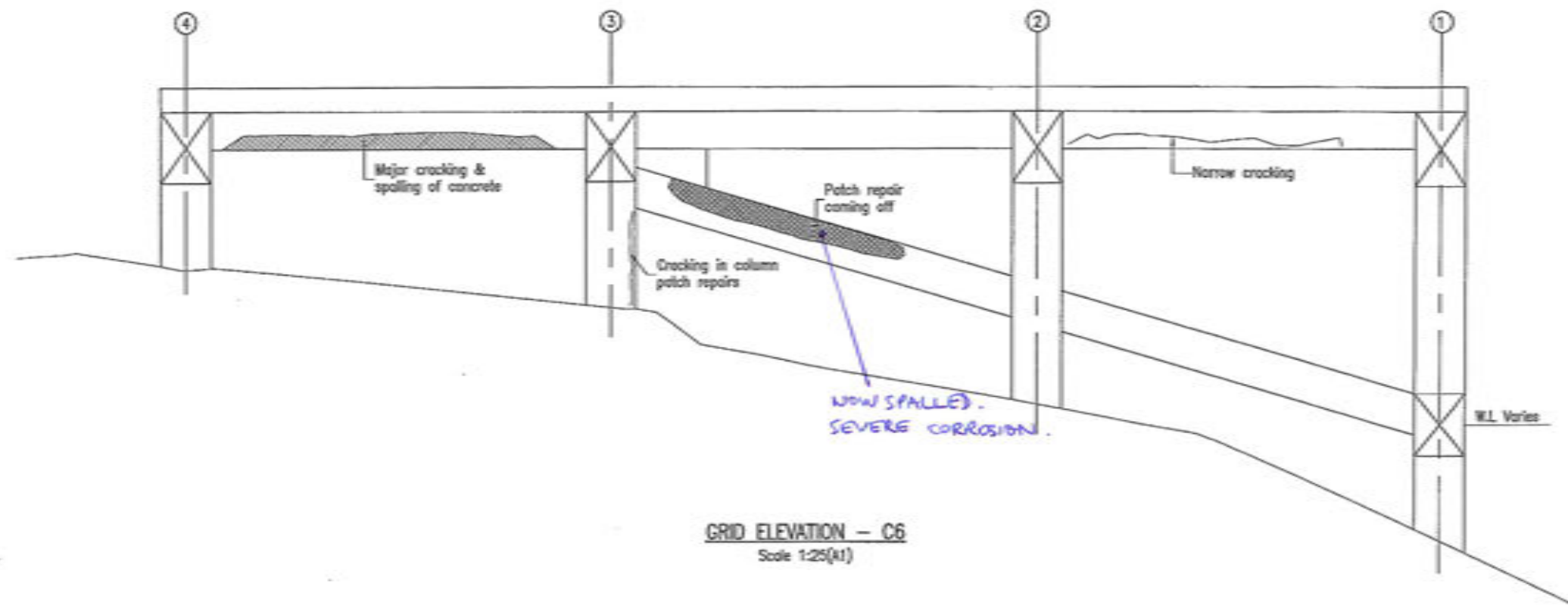

GRID ELEVATION - C6
Scale 1:25(A1)

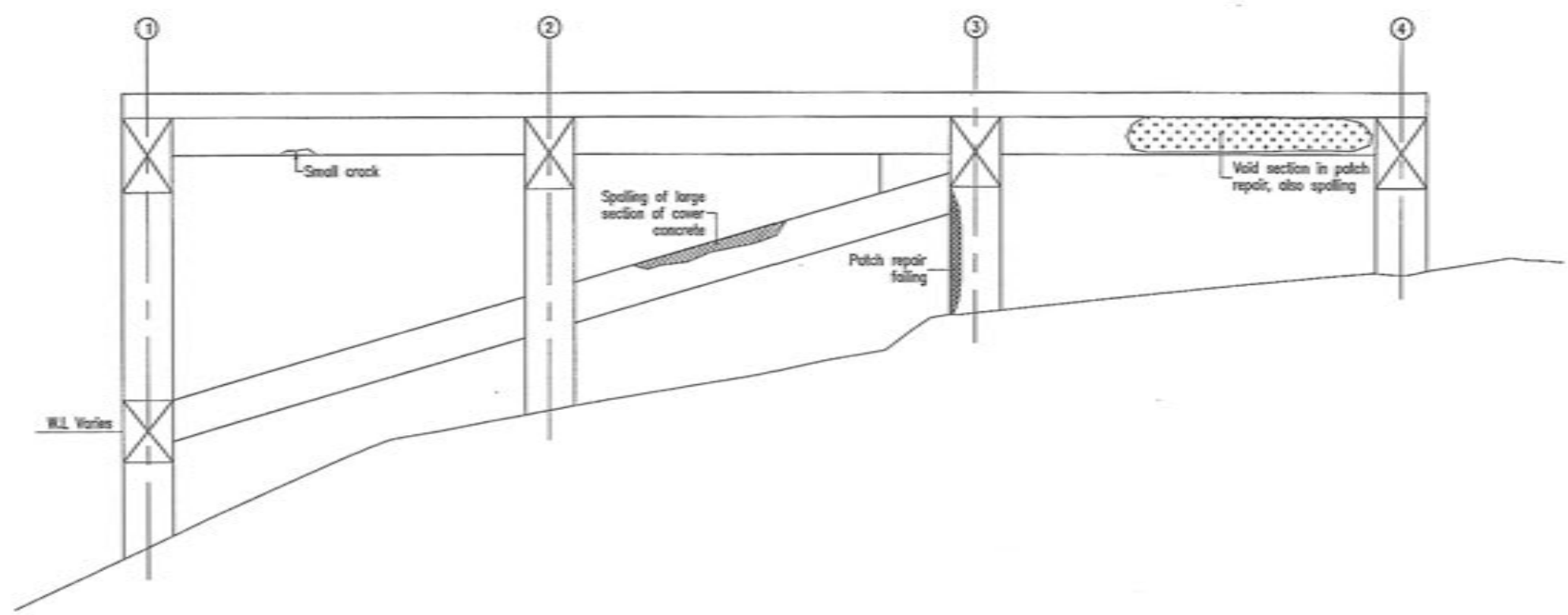

0 10 mm
50
100
200
300 mm

LEGEND

- Void in concrete
- Spalling of concrete
- Patch repair failure

NO.	BY	CHECKED	DATE
DESIGN			
DRAWN	K/Phy	D/Gr	March 2008
APPROVED			
AUTHORIT	APPD	DATE	

This drawing and its contents are the property of Opus International Consultants Limited. Any unauthorised employment or reproduction, in full or in part, is forbidden.



Hamilton Office

OPUS

Private Bay 3057
Hamilton, New Zealand
Tel: +64 7 838 824
Fax: +64 7 838 824

FILE: WAKATANE DISTRICT COUNCIL WAKATANE WHARF - INSPECTION WAKATANE					
1919 SECTION GRID ELEVATIONS C6					
STATUS	DRAFT	FILE	288081.04		
SCALE	AS SHOWN	PLUT DATE	14/03/08 @ 10:44	FEATURE IDENTIFIER	2/214/177
		CODE	2204	SHEET	24
		REASON	RO		

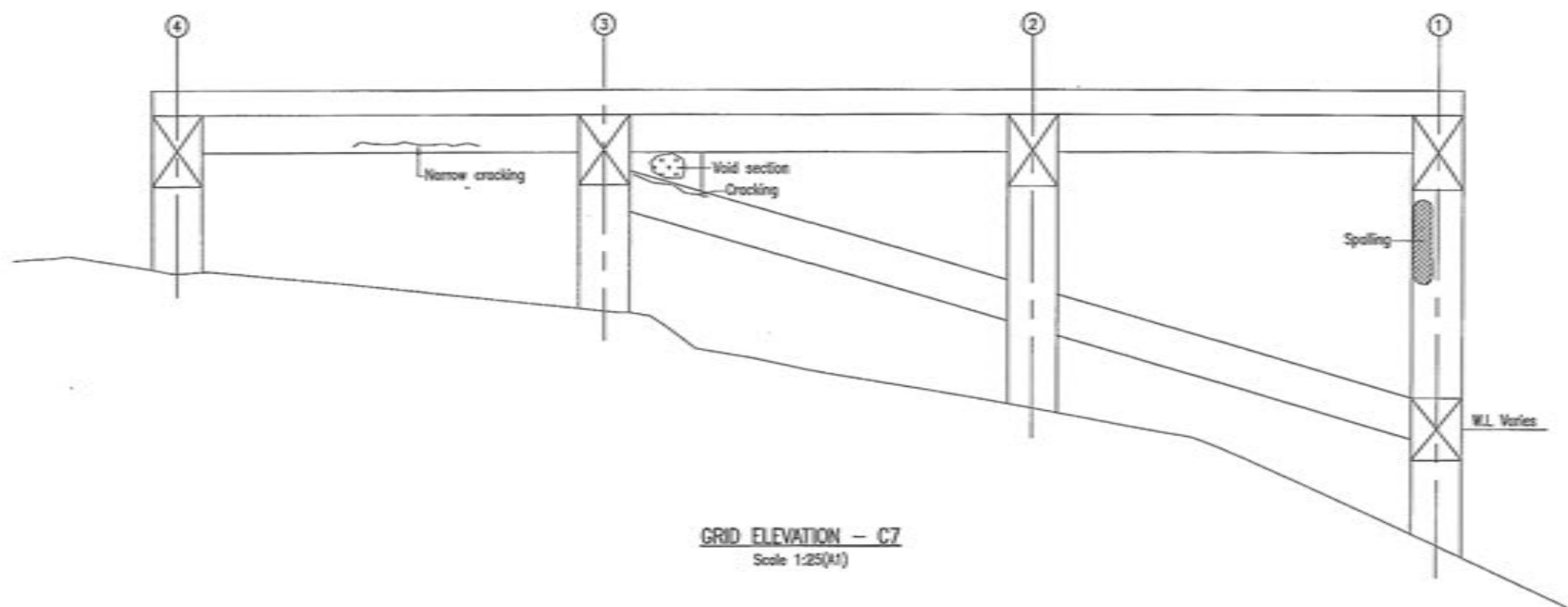

GENERIC SCALE 0 100 200 300 mm

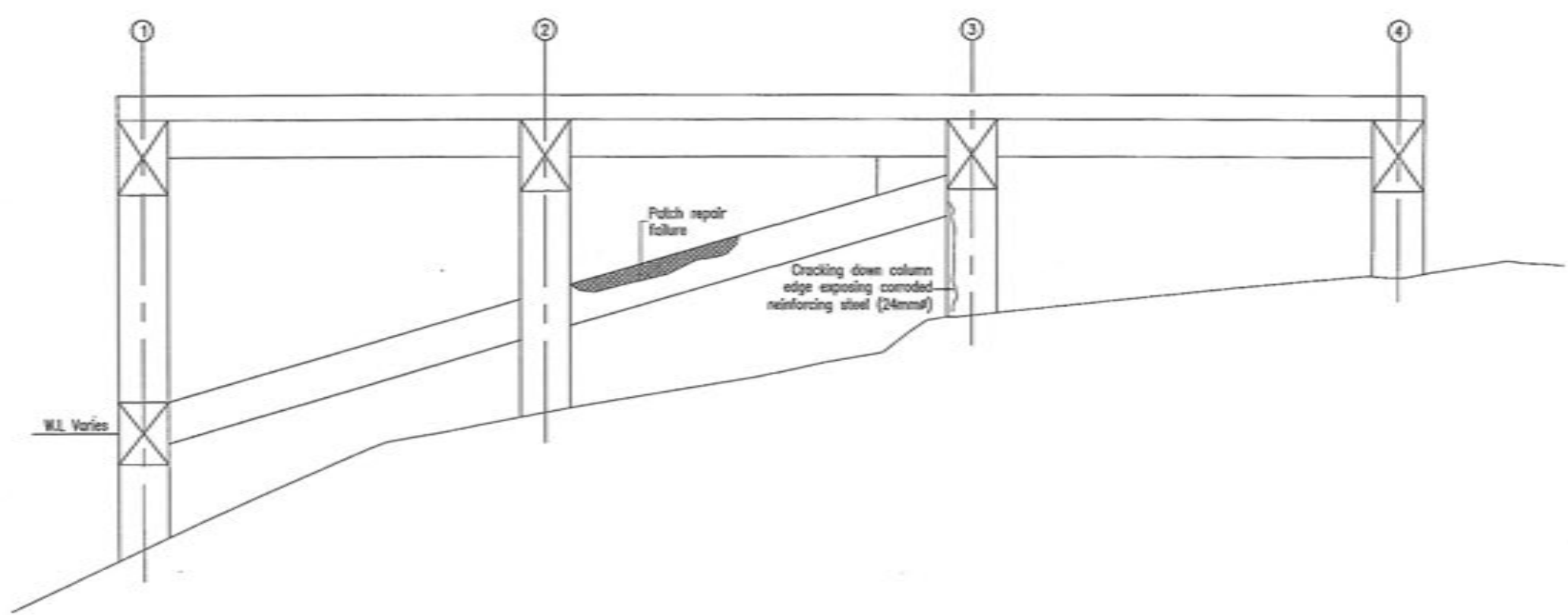

GRID ELEVATION - C7
Scale 1:25(A1)



LEGEND

-  Void in concrete
-  Spalling of concrete
-  Patch repair failure

NO.	BY	CHECKED	DATE
DESIGN			
DRAWN	KPhyn	SNo	March 2008
APPROVED			
This drawing and its contents are the property of Opus International Consultants Limited. Any unauthorised employment or reproduction, in full or in part, is forbidden.			



Hamilton Office

Private Bag 3027
Hamilton, New Zealand

Tel: 484 7 838 824
Fax: 484 7 838 824

OPUS

REF: WAIKATANE DISTRICT COUNCIL WAIKATANE WHARF : INSPECTION WAIKATANE					
1919 SECTION GRID ELEVATIONS C7					
SINGS	DRAFT	FILE	288081.04		
SCALE	PLUT DATE	FEATURE DESCRIPTOR	CODE	SHEET	REVISION
AS SHOWN	14/03/08 @ 10:44	2/214/177	2204	25	RO

15/03/2008 1115

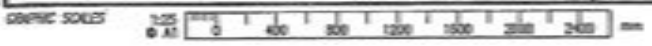

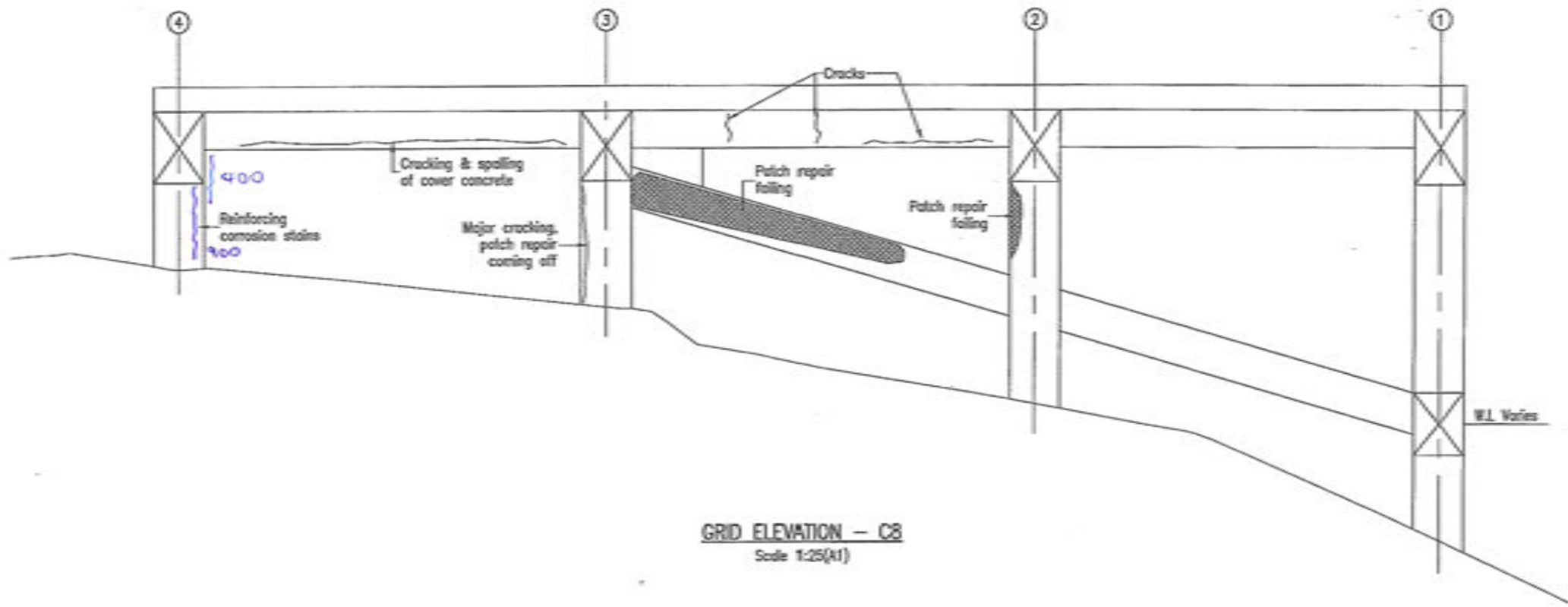

g:\200000\288081.04_000\waiakatake wharf\prod\2_214_177_15-31.dwg - 2500 ORIGINAL SHEET SIZE A1 (B46204)

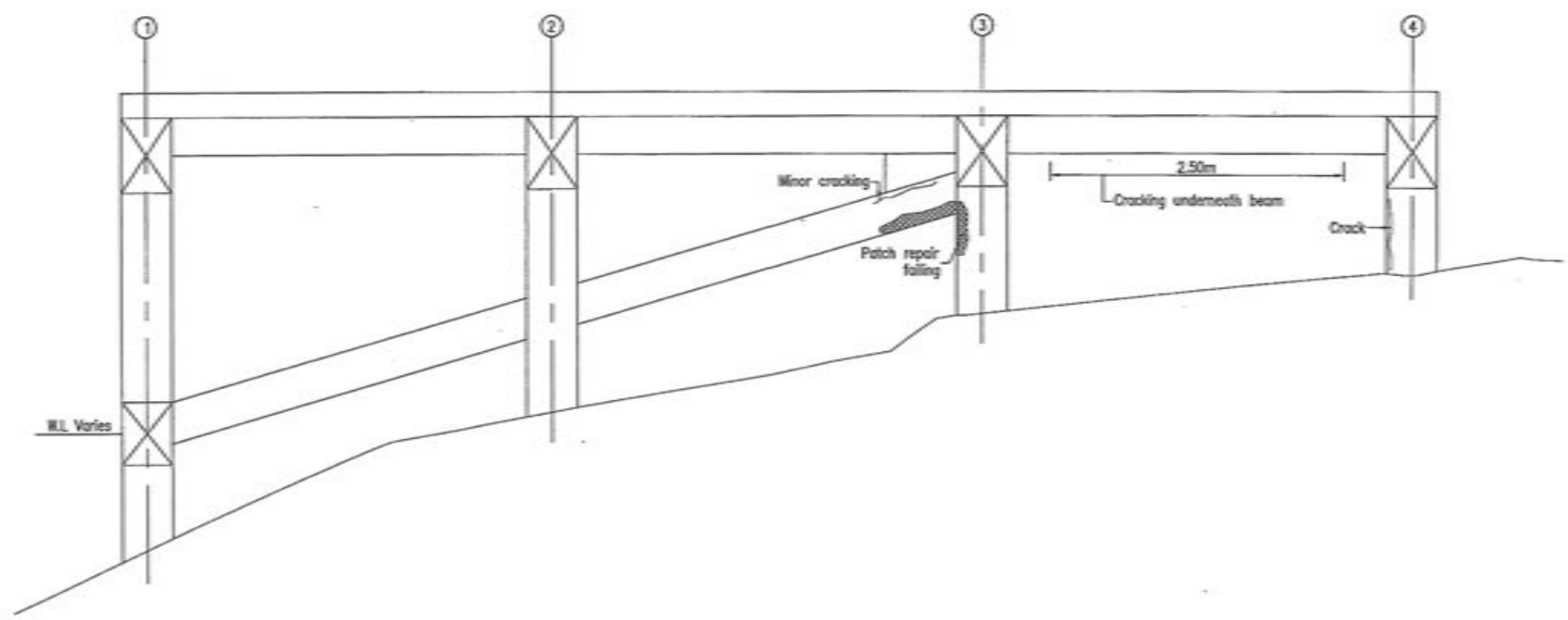

GRID ELEVATION - C8
Scale 1:25(A1)



LEGEND

-  Void in concrete
-  Spalling of concrete
-  Patch repair failure

NO.	BY	CHECKED	DATE
DESIGN			
DRAWN	KPhlyn	D.Nor	March 2008
APPROVED			
APPROVED			

This drawing and its contents are the property of Opus International Consultants Limited. Any unauthorised employment or reproduction, in full or in part, is forbidden.



Hamilton Office

OPUS

Private Bag 2057
Hamilton, New Zealand
Tel: +64 7 838 8344
Fax: +64 7 838 8324

FILE WHAKATANE DISTRICT COUNCIL WHAKATANE WHARF : INSPECTION WHAKATANE			
1919 SECTION GRID ELEVATIONS C8			
DRAWN	DRAFT	FILE	288081.04
SCALE	PLT DATE	FEATURE IDENTIFIER	CORE SHEET ROOM
AS SHOWN	14/03/08 @ 10:44	2/214/177	2204 26 RO

25/03/2008 11:15

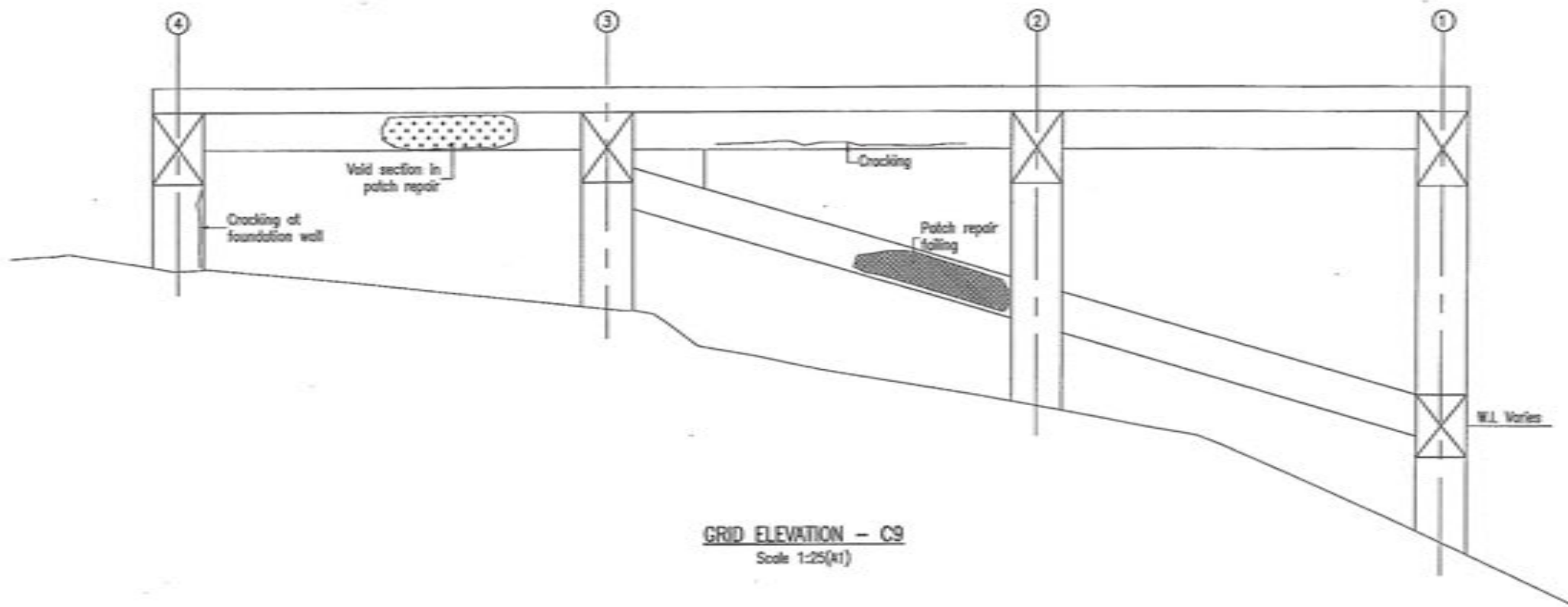

GRID ELEVATION - C9
Scale 1:25(A1)

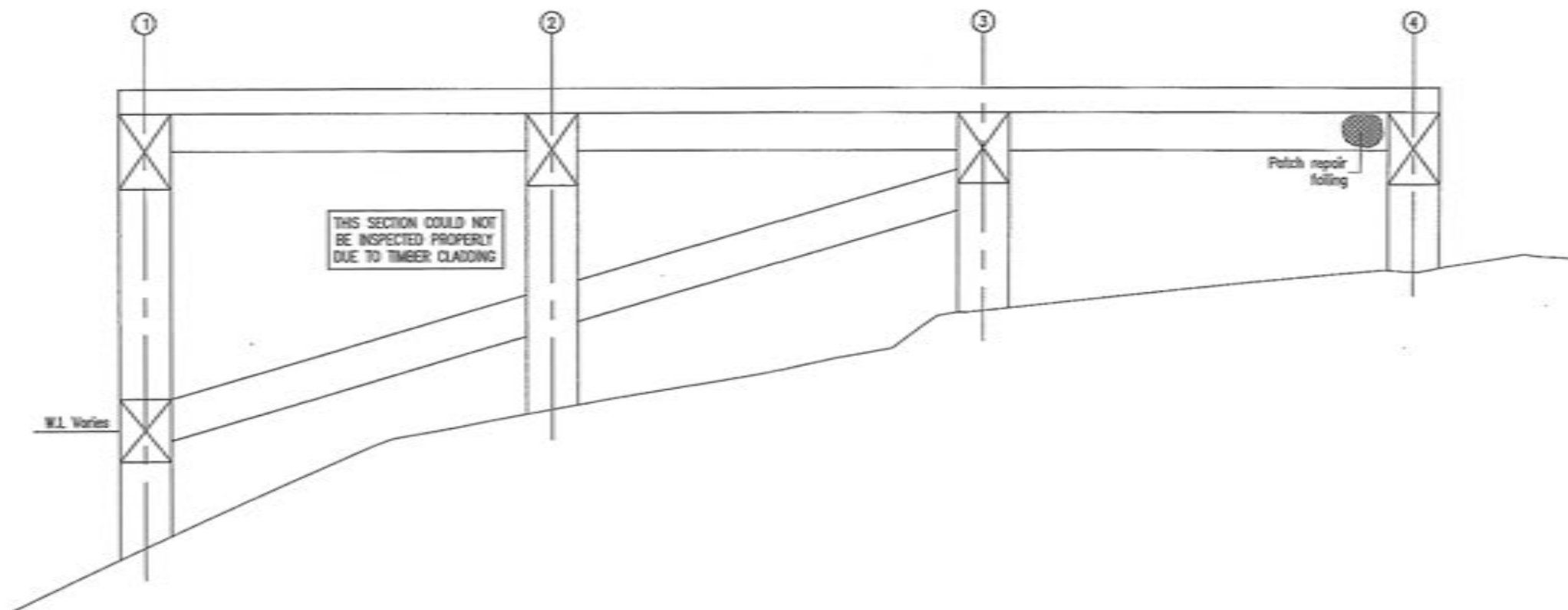

300mm
100
50
0 10mm

LEGEND

-  Void in concrete
-  Spalling of concrete
-  Patch repair failure

NO.	REVISION	BY	CHECKED	DATE



Hamilton Office

OPUS

Private Bay 3057
Hamilton, New Zealand
Tel: +64 7 838 8299
Fax: +64 7 838 8329

FILE WHAKATANE DISTRICT COUNCIL WHAKATANE WHARF : INSPECTION WHAKATANE			
1919 SECTION GRID ELEVATIONS C9			
STATUS	DRAFT	FILE	288081.04
SCALE	AS SHOWN	PLUT DATE	14/03/08 @ 10:44
DATE/REVISION	2/214/177	CODE	2204
SHEET	27	REVISION	RD

GRAPHIC SCALES 1:25 0 400 800 1200 1600 2000 2400 mm

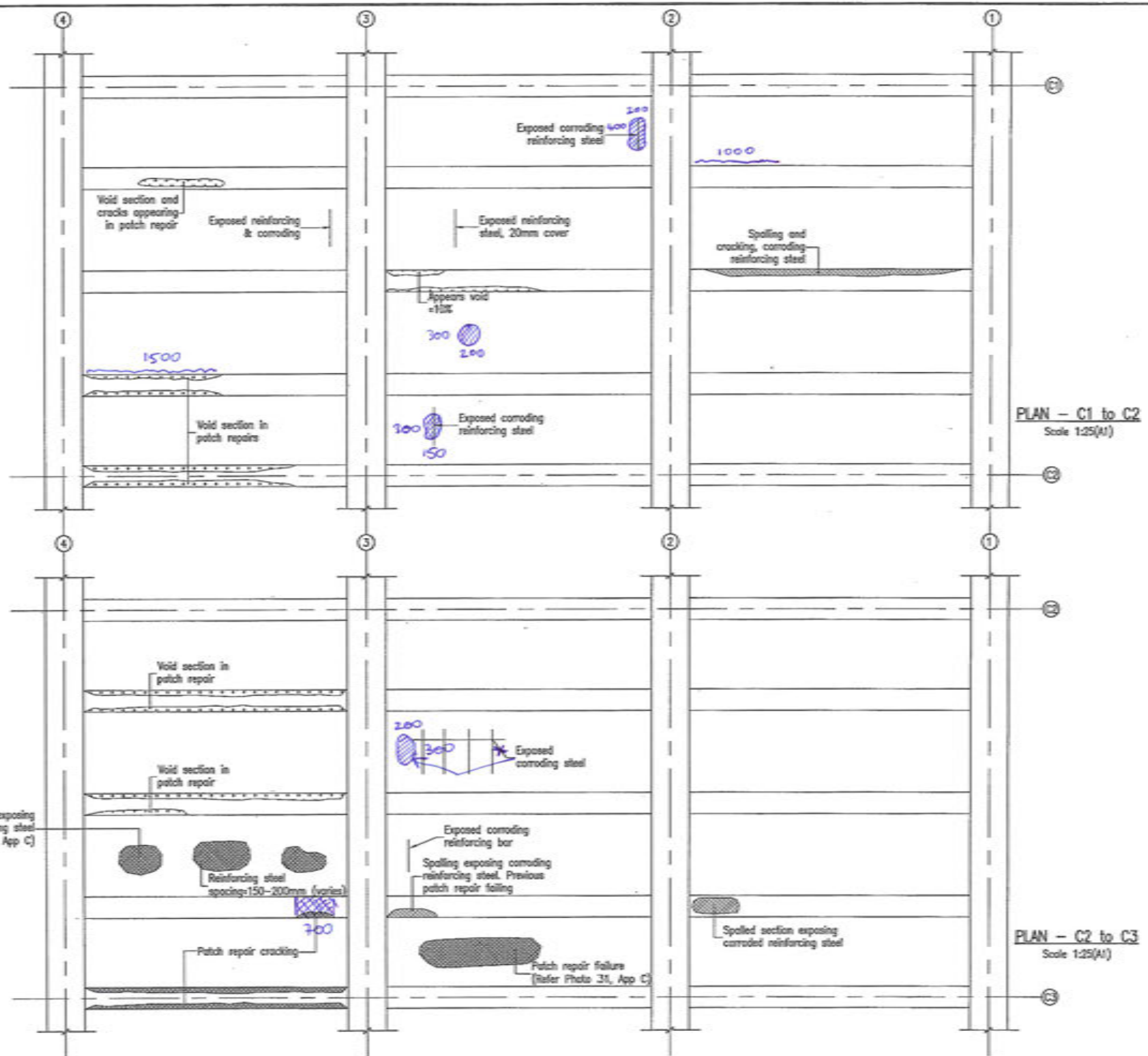

300mm
200
100
50
0 10mm



PLAN - C1 to C2
Scale 1:25(A1)

PLAN - C2 to C3
Scale 1:25(A1)

LEGEND

-  Void in concrete
-  Spalling of concrete
-  Patch repair failure

NO.	BY	CHECKED	DATE
DESIGN			
DRAWN	N.Polya	D.Hob	March 2008
APPROVED			

This drawing and its contents are the property of Opus International Consultants Limited. Any unauthorised employment or reproduction, in full or in part, is forbidden.



Hamilton Office

OPUS

1000 Bay 3057
Hamilton, New Zealand
Tel: +64 7 838 8200
Fax: +64 7 838 8201

FILE WHAKATANE DISTRICT COUNCIL WHAKATANE WHARF : INSPECTION WHAKATANE					
1919 SECTION PLAN BETWEEN GRIDS C1/C2, C2/C3					
SERIES	DRAFT	FILE	288081.04		
SCALE	AS SHOWN	PLST DATE	14/03/08 @ 10:44	FEATURE NUMBER	2/214/177
		DATE	2204	SHEET	28
		REVISION			RO

20/03/2008 11:13

GRAPHIC SCALES 1:25 0 50 100 150 200 250 mm

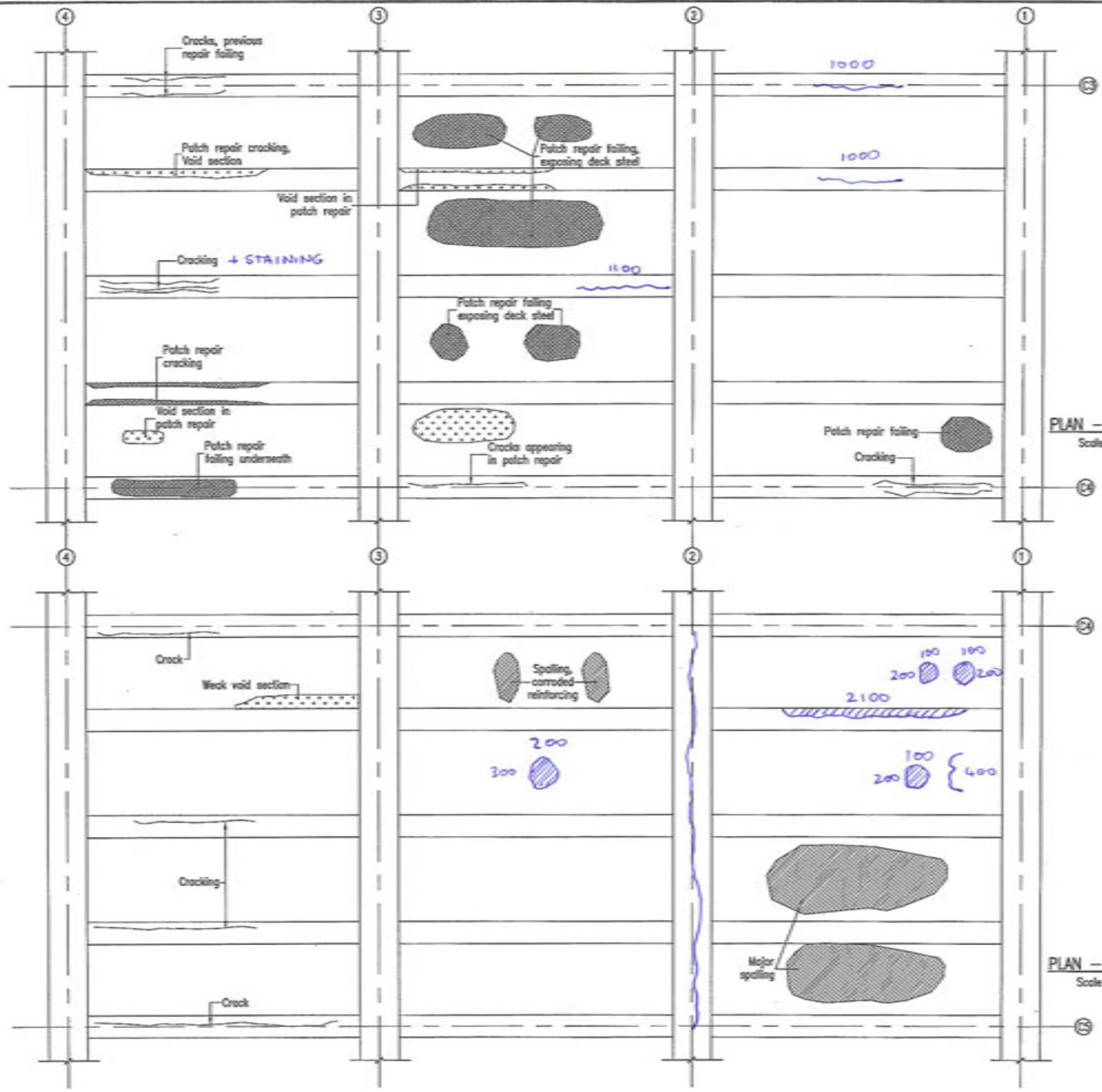

300mm
200
100
0 10mm



PLAN - C3 to C4
Scale 1:25(A1)

PLAN - C4 to C5
Scale 1:25(A1)

LEGEND

-  Void in concrete
-  Spalling of concrete
-  Patch repair failure

NO.	BY	CHECKED	DATE
DESIGN			
DRAWN	K.Palyn	D.Kear	March 2016
APPROVED			
REVISION			



Hamilton Office

OPUS

1/Heke Bay 2017
Hamilton, New Zealand

Tel: +64 7 638 6344
Fax: +64 7 638 6324

FILE WHAKATANE DISTRICT COUNCIL WHAKATANE WHARF : INSPECTION WHAKATANE					
1919 SECTION PLAN BETWEEN GRIDS C3/C4, C4/C5					
STATUS	DRAFT	FILE	288081.04		
SCALE	AS SHOWN	PLLOT DATE	FEATURE NUMBER	CODE	SHEET
		14/03/08 @ 10:44	2/214/177	2204	29
					RD



0 10 mm
50
100
200
300 mm

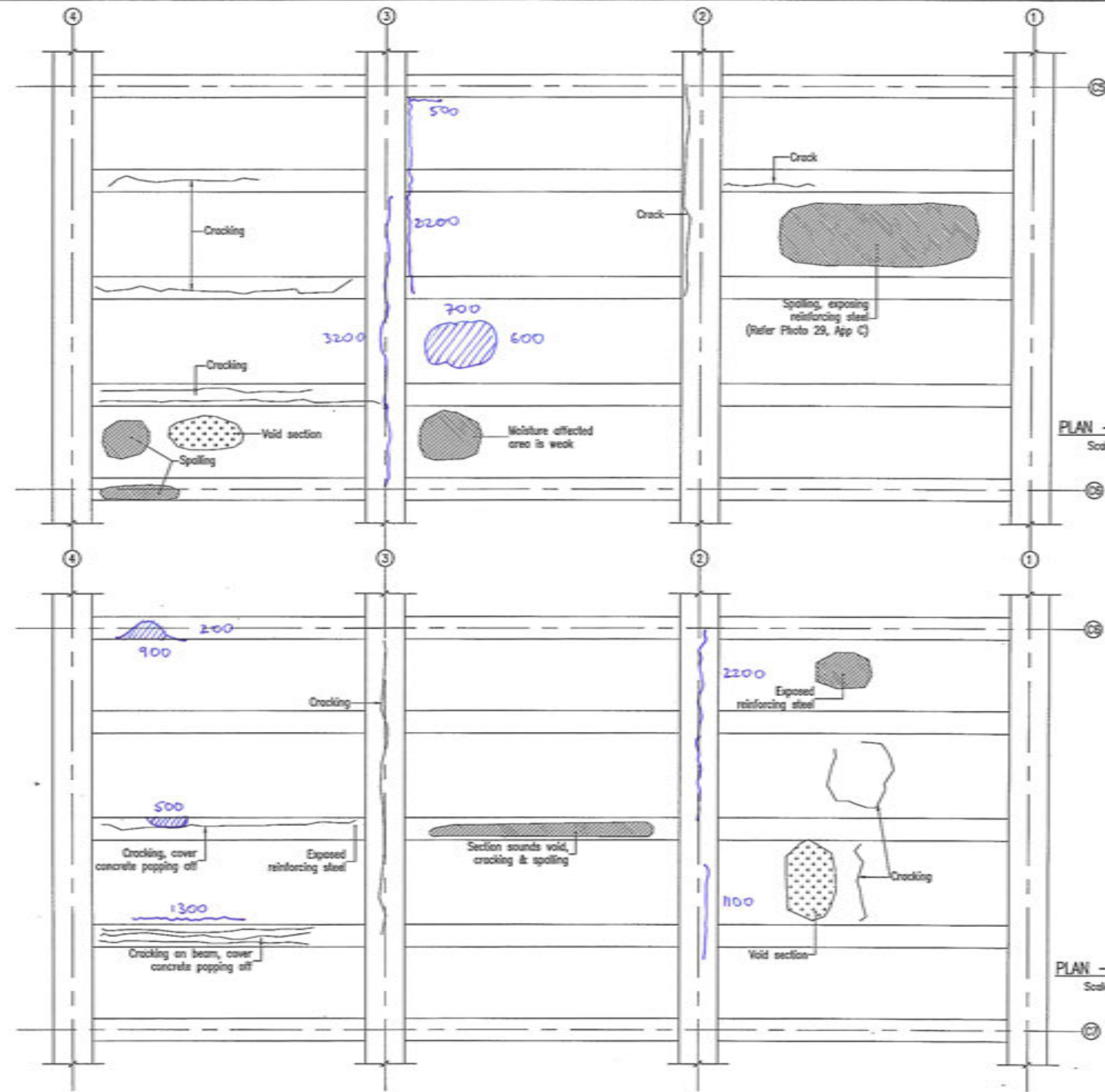

PLAN - C5 to C6
Scale 1:25(A1)

PLAN - C6 to C7
Scale 1:25(A1)

LEGEND

- Void in concrete
- Spalling of concrete
- Patch repair failure

NO	BY	CHECKED	DATE
DESIGN			
DRAWN	N/Polyn	G.Hill	March 2008
APPROVED			
DESIGNED		APPD	DATE

This drawing and its contents are the property of Opus International Consultants Limited. Any unauthorized employment or reproduction, in full or in part, is forbidden.



Hamilton Office
 10 Fife Street 2007
 Hamilton, New Zealand
 Tel: +64 7 838 8384
 Fax: +64 7 838 8324

TITLE PLAN BETWEEN GRIDS C5/C6, C6/C7 WHAKATANE WHARF - INSPECTION WHAKATANE					
1919 SECTION GRID ELEVATIONS C1					
STATUS	DRAFT	FILE	288081.04		
SCALE	AS SHOWN	PLLOT DATE	14/03/08 @ 10:44	FEATURE IDENTIFIER	2/214/177
		CODE	2204	SHEET	30
		REVISION			RD

18/03/2008 11:15

0 50 100 150 200 250 mm

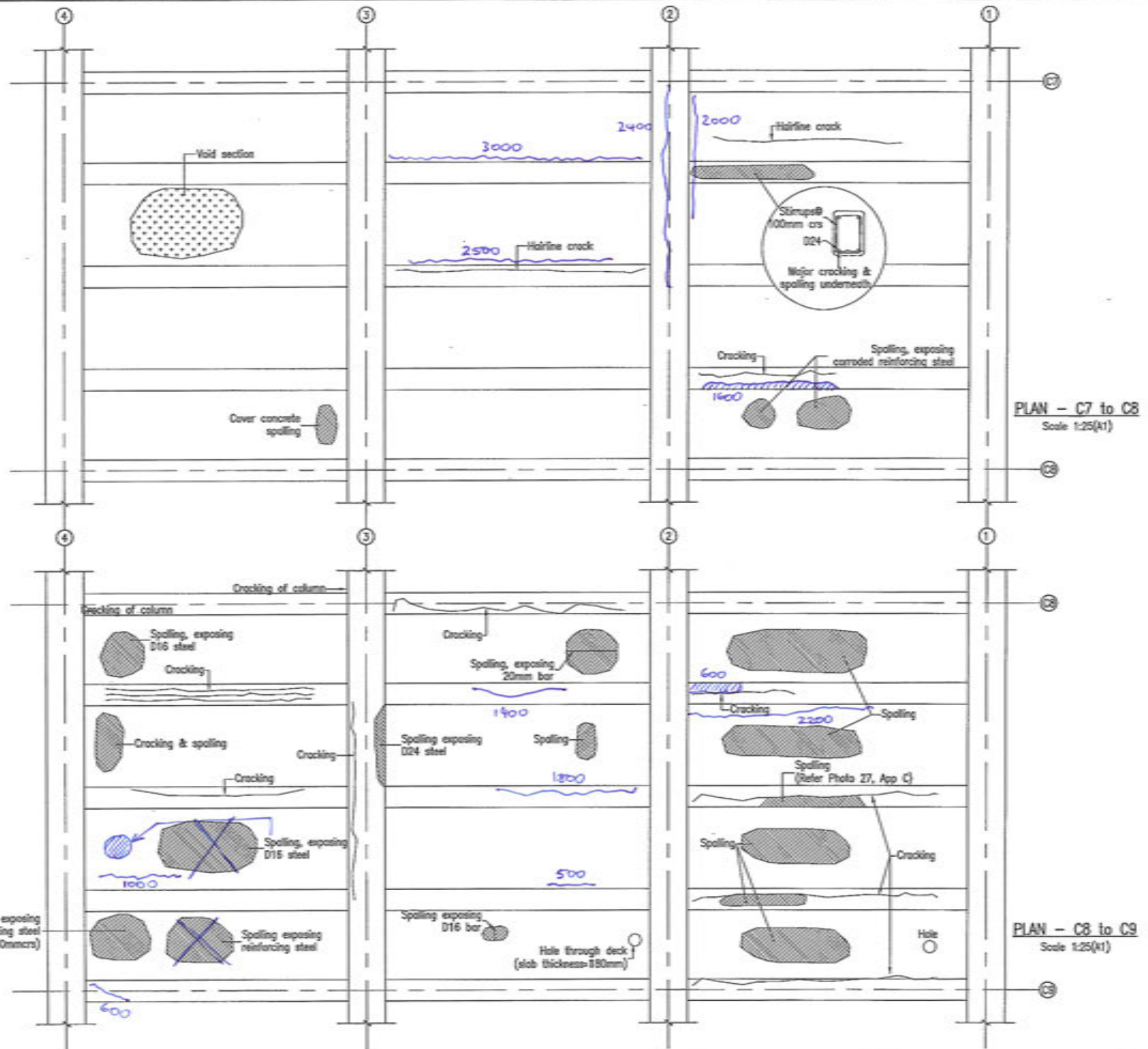

PLAN - C7 to C8
Scale 1:25(x1)

PLAN - C8 to C9
Scale 1:25(x1)

LEGEND

- Void in concrete
- Spalling of concrete
- Patch repair failure

REVISION	APP'D	DATE	BY	CHECKED	DATE
DESIGN					
DRAWN			N.Pulyn	D.Kirk	March 2008
APPROVED					
This drawing and its contents are the property of Opus International Consultants Limited. Any unauthorised employment or reproduction, in full or in part, is forbidden.					



Hamilton Office

OPUS

Private Bag 3037
Hamilton, New Zealand
Tel: +61 7 838 8344
Fax: +61 7 838 8344

WHAKATANE DISTRICT COUNCIL WHAKATANE WHARF : INSPECTION WHAKATANE					
1919 SECTION PLAN BETWEEN GRIDS C7/C8, C8/C9					
STATUS	DRAFT	FILE	288081.04		
SCALE	AS SHOWN	PLAT DATE	14/03/08 @ 10:44	FEATURE NUMBER	2/214/177
		CODE	2204	SHEET	31
		REGION			RD



Appendix C: Schedule of Repair Costs

Member Location Key:

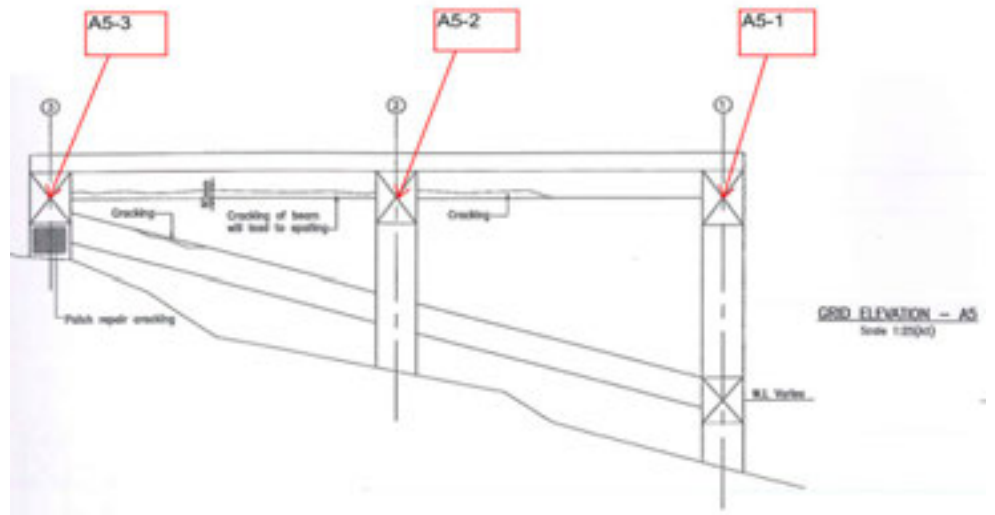
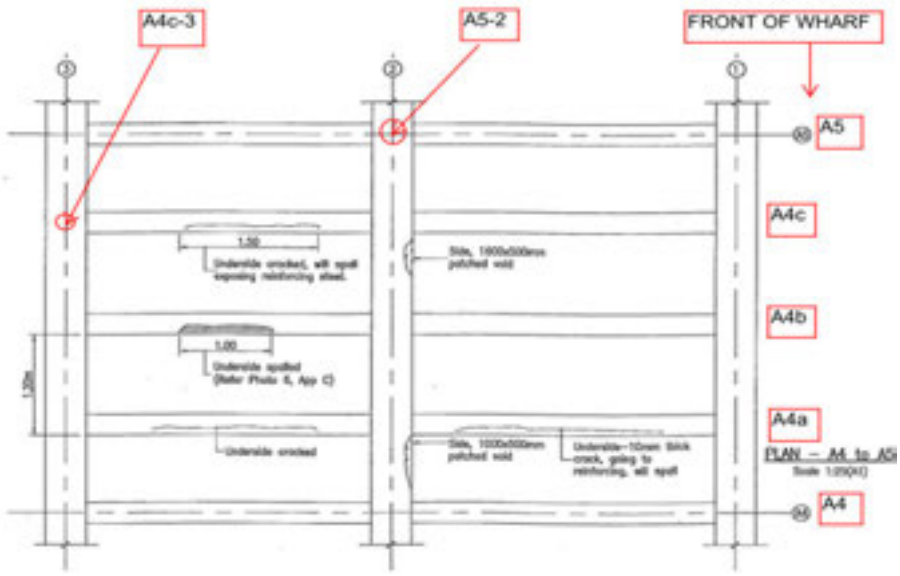

Inspected 5th November 2014

Concrete repair cost / m3
 \$ 30,000.00 \$ 37,500.00

Concrete repairs required

Section	Member description	Member location		Defect	Defect Location (North, South, East, West, Top, Bottom faces)	Repair dimensions estimate (assumes break out repair with sprayed concrete)					Estimated Costs	
		Start	Finish			Length (m)	Width (m)	Depth (m)	Volume (m3)	Priority	Baseline cost	Sensitivity
1936 - Bay A1-A2	Pile	A1-2		Crack	E	0.4	0.1	0.1	0.004	High	\$ 120.00	\$ 150.00
	Pile	A1-2		Crack	W	0.8	0.4	0.1	0.032	High	\$ 960.00	\$ 1,200.00
	Pile	A1-1		Crack	E	0.5	0.1	0.1	0.005	High	\$ 150.00	\$ 187.50
	Raking beam	A1-2	A1-3	Crack	E	1.6	0.15	0.1	0.024	Low	\$ 720.00	\$ 900.00
	Raking beam	A1-2	A1-3	Crack	E	0.7	0.1	0.1	0.007	Low	\$ 210.00	\$ 262.50
	Raking beam	A1-2	A1-3	Crack	E	0.4	0.1	0.1	0.004	Low	\$ 120.00	\$ 150.00
	Raking beam	A1-2	A1-3	Crack	W	1	0.1	0.1	0.01	Low	\$ 300.00	\$ 375.00
	Raking beam	A1-2	A1-3	Crack	T	1.4	0.1	0.1	0.014	Low	\$ 420.00	\$ 525.00
	Longitudinal beam	A1-2	A2-2	Crack	B	2	0	0	0	High	\$ -	\$ -
	Longitudinal beam	A1-2	A2-2	Crack	B	1.5	0.1	0.1	0.015	High	\$ 450.00	\$ 562.50
	Longitudinal beam	A1-2	A2-2	Crack	N	2.3	0.4	0.1	0.092	High	\$ 2,760.00	\$ 3,450.00
	Longitudinal beam	A1-2	A2-2	Void	N	0.45	0.15	0.1	0.00675	High	\$ 202.50	\$ 253.13
	Intermediate beam	A1a-1	A1a-2	Crack	B	1	0.1	0.1	0.01	High	\$ 300.00	\$ 375.00
	Intermediate beam	A1c-1	A1c-2	Cracks, spalling	B,E,W	3.2	0.25	0.1	0.08	High	\$ 2,400.00	\$ 3,000.00
	Intermediate beam	A1c-2	A1c-3	Cracks	B	0.4	0.1	0.1	0.004	High	\$ 120.00	\$ 150.00
	Slab	A1-2	A2-3	Spalling	B	0.8	0.7	0.1	0.056	High	\$ 1,680.00	\$ 2,100.00
	Slab	A1-2	A2-3	Spalling	B	1.3	0.9	0.1	0.117	High	\$ 3,510.00	\$ 4,387.50
	Slab	A1-2	A2-3	Spalling	B	1	1	0.1	0.1	High	\$ 3,000.00	\$ 3,750.00
Slab	A1-2	A2-3	Spalling	B	1	0.4	0.1	0.04	High	\$ 1,200.00	\$ 1,500.00	
Slab	A1-1	A2-2	Spalling	B	0.6	0.3	0.1	0.018	High	\$ 540.00	\$ 675.00	
1936 - Bay A2-A3	Pile	A2-1		Crack	W	0.6	0.1	0.1	0.006	High	\$ 180.00	\$ 225.00
	Pile	A2-2		Spalling	W	0.6	0.1	0.1	0.006	High	\$ 180.00	\$ 225.00
	Pile	A2-2		Void	E	0.5	0.6	0.1	0.03	High	\$ 900.00	\$ 1,125.00
	Raking beam	A2-2	A2-3	Spalling	E	1	0.3	0.1	0.03	Low	\$ 900.00	\$ 1,125.00
	Raking beam	A2-2	A2-3	Crack	E,W	2.3	0.3	0.1	0.069	Low	\$ 2,070.00	\$ 2,587.50
	Transverse beam	A2-1	A2-2	Spalling	E,B	0.5	0.15	0.15	0.01125	High	\$ 337.50	\$ 421.88
	Transverse beam	A2-1	A2-2	Crack	B	0.3	0.1	0.1	0.003	High	\$ 90.00	\$ 112.50
	Transverse beam	A2-2	A2-3	Crack	B	0.7	0.1	0.1	0.007	High	\$ 210.00	\$ 262.50
	Longitudinal beam	A2-2	A3-2	Spalling	B	0.5	0.2	0.1	0.01	High	\$ 300.00	\$ 375.00
	Longitudinal beam	A2-2	A3-2	Crack	B	1.5	0.2	0.1	0.03	High	\$ 900.00	\$ 1,125.00
	Longitudinal beam	A2-2	A3-2	Void	S	0.7	0.6	0.5	0.21	High	\$ 6,300.00	\$ 7,875.00
	Longitudinal beam	A2-2	A3-2	Void	S	0.2	0.6	0.15	0.018	High	\$ 540.00	\$ 675.00
	Longitudinal beam	A2-3	A3-3	Crack	B	1.2	0.1	0.1	0.012	High	\$ 360.00	\$ 450.00
	Intermediate beam	A2a-2	A2a-3	Void	E,W	0.8	0.2	0.3	0.048	High	\$ 1,440.00	\$ 1,800.00
	Intermediate beam	A2b-1	A2b-2	Crack	B	3.2	0.25	0.1	0.08	High	\$ 2,400.00	\$ 3,000.00
	Intermediate beam	A2b-2	A2b-3	Crack	B	0.7	0.1	0.1	0.007	High	\$ 210.00	\$ 262.50
	Intermediate beam	A2b-2	A2b-3	Crack	B	0.7	0.1	0.1	0.007	High	\$ 210.00	\$ 262.50
	Intermediate beam	A2b-2	A2b-3	Spalling	B	0.3	0.3	0.15	0.0135	High	\$ 405.00	\$ 506.25
	Intermediate beam	A2c-1	A2c-2	Crack	B	3	0.25	0.1	0.075	High	\$ 2,250.00	\$ 2,812.50
	Intermediate beam	A2c-2	A2c-3	Crack	B	0.7	0.1	0.1	0.007	High	\$ 210.00	\$ 262.50
	Intermediate beam	A2c-2	A2c-3	Void	B	1.3	0.3	0.2	0.078	High	\$ 2,340.00	\$ 2,925.00
	Intermediate beam	A2c-2	A2c-3	Crack	B	1.5	0.2	0.1	0.03	High	\$ 900.00	\$ 1,125.00
	Intermediate beam	A2c-2	A2c-3	Void	B	1	0.18	0.3	0.054	High	\$ 1,620.00	\$ 2,025.00
	Slab	A2a-2	A2b-3	Spalling	B	0.8	0.5	0.1	0.04	High	\$ 1,200.00	\$ 1,500.00
	Slab	A2b-2	A2c-3	Spalling	B	0.9	0.9	0.1	0.081	High	\$ 2,430.00	\$ 3,037.50
	Slab	A2b-2	A2c-3	Void	B	0.5	0.22	0.1	0.011	High	\$ 330.00	\$ 412.50
	Slab	A2c-1	A3-2	Spalling	B	0.2	0.2	0.1	0.004	High	\$ 120.00	\$ 150.00
	Slab	A2c-1	A3-2	Spalling	B	0.4	0.3	0.1	0.012	High	\$ 360.00	\$ 450.00

Concrete repairs required

Section	Member description	Member location		Defect	Defect Location (North, South, East, West, Top, Bottom faces)	Repair dimensions estimate (assumes break out repair with sprayed concrete)					Estimated Costs		
		Start	Finish			Length (m)	Width (m)	Depth (m)	Volume (m3)	Priority	Baseline cost	Sensitivity	
1936 - Bay A3-A4	Pile	A3-1		Crack	S	1	0.1	0.1	0.01	High	\$ 300.00	\$ 375.00	
	Pile	A3-1		Void	W	0.6	0.27	0.1	0.0162	High	\$ 486.00	\$ 607.50	
	Pile	A3-2		Crack	E	0.5	0.1	0.1	0.005	High	\$ 150.00	\$ 187.50	
	Pile	A3-2		Crack	N	0.9	0.1	0.1	0.009	High	\$ 270.00	\$ 337.50	
	Pile	A3-2		Crack	W	0.4	0.1	0.1	0.004	High	\$ 120.00	\$ 150.00	
	Pile	A3-2		Void	W	0.57	0.33	0.1	0.01881	High	\$ 564.30	\$ 705.38	
	Raking beam	A3-1	A3-2	Crack	E	1	0.1	0.1	0.01	Low	\$ 300.00	\$ 375.00	
	Raking beam	A3-2	A3-3	Crack	E	0.7	0.1	0.1	0.007	Low	\$ 210.00	\$ 262.50	
	Raking beam	A3-2	A3-3	Void	E	0.4	0.27	0.1	0.0108	Low	\$ 324.00	\$ 405.00	
	Raking beam	A3-2	A3-3	Void	E	0.3	0.1	0.2	0.006	Low	\$ 180.00	\$ 225.00	
	Raking beam	A3-2	A3-3	Crack	E	1.2	0.1	0.1	0.012	Low	\$ 360.00	\$ 450.00	
	Raking beam	A3-2	A3-3	Void	E	0.9	0.35	0.1	0.0315	Low	\$ 945.00	\$ 1,181.25	
	Transverse beam	A3-2	A3-3	Crack	E	0.9	0.1	0.1	0.009	High	\$ 270.00	\$ 337.50	
	Transverse beam	A3-2	A3-3	Spalling	E,B,W	1.2	0.25	0.15	0.045	High	\$ 1,350.00	\$ 1,687.50	
	Longitudinal beam	A3-1	A4-1	Void	N	0.6	0.23	0.1	0.0138	High	\$ 414.00	\$ 517.50	
	Longitudinal beam	A3-1	A4-1	Void	B	0.3	0.15	0.1	0.0045	High	\$ 135.00	\$ 168.75	
	Longitudinal beam	A3-1	A4-1	Void	N	0.5	0.2	0.1	0.01	High	\$ 300.00	\$ 375.00	
	Longitudinal beam	A3-1	A4-1	Void	S	0.35	0.25	0.1	0.00875	High	\$ 262.50	\$ 328.13	
	Longitudinal beam	A3-3	A4-3	Crack	N	1.2	0.1	0.1	0.012	High	\$ 360.00	\$ 450.00	
	Intermediate beam	A3a-1	A3a-2	Spalling	E,B	1.2	0.1	0.1	0.012	High	\$ 360.00	\$ 450.00	
	Intermediate beam	A3a-2	A3a-3	Crack	E,W,B	1.8	0.25	0.1	0.045	High	\$ 1,350.00	\$ 1,687.50	
	Intermediate beam	A3a-2	A3a-3	Spalling	W,B	0.3	0.25	0.15	0.01125	High	\$ 337.50	\$ 421.88	
	Intermediate beam	A3a-2	A3a-3	Crack	W,B	0.3	0.1	0.1	0.003	High	\$ 90.00	\$ 112.50	
	Intermediate beam	A3b-2	A3b-3	Crack	E,W,B	1	0.25	0.1	0.025	High	\$ 750.00	\$ 937.50	
	Intermediate beam	A3c-1	A3c-2	Crack	B	0.6	0.1	0.1	0.006	High	\$ 180.00	\$ 225.00	
	Intermediate beam	A3c-1	A3c-2	Crack	B	0.5	0.1	0.1	0.005	High	\$ 150.00	\$ 187.50	
	Intermediate beam	A3c-2	A3c-3	Spalling	B	3	0.25	0.1	0.075	High	\$ 2,250.00	\$ 2,812.50	
	1936 - Bay A4-A5	Pile	A4-2		Void	E	0.25	0.25	0.1	0.00625	High	\$ 187.50	\$ 234.38
		Pile	A4-2		Void	E	0.25	0.25	0.1	0.00625	High	\$ 187.50	\$ 234.38
		Pile	A4-2		Void	S	0.4	0.4	0.1	0.016	High	\$ 480.00	\$ 600.00
		Pile	A4-2		Crack	E	0.3	0.1	0.1	0.003	High	\$ 90.00	\$ 112.50
		Pile	A4-2		Crack	E	0.4	0.1	0.1	0.004	High	\$ 120.00	\$ 150.00
		Pile	A4-2		Crack	W	0.5	0.1	0.1	0.005	High	\$ 150.00	\$ 187.50
Pile		A4-2		Crack	W	0.5	0.1	0.1	0.005	High	\$ 150.00	\$ 187.50	
Raking beam		A4-2	A4-3	Crack	E	1.5	0.3	0.1	0.045	Low	\$ 1,350.00	\$ 1,687.50	
Raking beam		A4-2	A4-3	Crack	W	1	0.1	0.1	0.01	Low	\$ 300.00	\$ 375.00	
Raking beam		A4-2	A4-3	Void	E	3	0.4	0.1	0.12	Low	\$ 3,600.00	\$ 4,500.00	
Transverse beam		A4-1	A4-2	Spalling	E	0.9	0.1	0.1	0.009	High	\$ 270.00	\$ 337.50	
Transverse beam		A4-2	A4-3	Crack	E	0.3	0.1	0.1	0.003	High	\$ 90.00	\$ 112.50	
Transverse beam		A4-2	A4-3	Spalling	E	1.7	0.15	0.15	0.03825	High	\$ 1,147.50	\$ 1,434.38	
Transverse beam		A4-2	A4-3	Crack	W	1.5	0.1	0.1	0.015	High	\$ 450.00	\$ 562.50	
Longitudinal beam		A4-2	A5-2	Void	N,B	1	0.5	0.1	0.05	High	\$ 1,500.00	\$ 1,875.00	
Longitudinal beam		A4-2	A5-2	Crack	B	1.4	0.1	0.1	0.014	High	\$ 420.00	\$ 525.00	
Longitudinal beam		A4-2	A5-2	Crack	B	0.45	0.1	0.1	0.0045	High	\$ 135.00	\$ 168.75	
Longitudinal beam		A4-2	A5-2	Void	N,B	1.6	0.5	0.1	0.08	High	\$ 2,400.00	\$ 3,000.00	
Longitudinal beam		A4-2	A5-2	Crack	B	0.45	0.1	0.1	0.0045	High	\$ 135.00	\$ 168.75	
Intermediate beam		A4a-1	A4a-2	Crack	B	2.6	0.25	0.1	0.065	High	\$ 1,950.00	\$ 2,437.50	
Intermediate beam		A4a-2	A4a-3	Crack	B	3.2	0.1	0.1	0.032	High	\$ 960.00	\$ 1,200.00	
Intermediate beam		A4b-1	A4b-2	Crack	B	0.3	0.1	0.1	0.003	High	\$ 90.00	\$ 112.50	
Intermediate beam		A4b-1	A4b-2	Crack	B	0.3	0.1	0.1	0.003	High	\$ 90.00	\$ 112.50	
Intermediate beam		A4b-1	A4b-2	Crack	B	1	0.1	0.25	0.025	High	\$ 750.00	\$ 937.50	
Intermediate beam		A4b-2	A4b-3	Spalling	B	1	0.2	0.25	0.05	High	\$ 1,500.00	\$ 1,875.00	
Intermediate beam		A4c-1	A4c-2	Crack	B	0.3	0.1	0.1	0.003	High	\$ 90.00	\$ 112.50	
Intermediate beam		A4c-1	A4c-2	Spalling	B	0.3	0.1	0.1	0.003	High	\$ 90.00	\$ 112.50	
Intermediate beam		A4c-2	A4c-3	Crack	B,E,W	1.8	0.25	0.1	0.045	High	\$ 1,350.00	\$ 1,687.50	
1936 - Bay A5-A6		Pile	A5-2		Crack	E	0.6	0.1	0.1	0.006	High	\$ 180.00	\$ 225.00
		Pile	A5-2		Spalling	E	1.1	0.1	0.3	0.033	High	\$ 990.00	\$ 1,237.50
		Pile	A5-3		Spalling	E	0.35	0.1	0.3	0.0105	High	\$ 315.00	\$ 393.75
		Pile	A5-3		Spalling	W	0.35	0.1	0.3	0.0105	High	\$ 315.00	\$ 393.75
		Raking beam	A5-2	A5-3	Crack	E	0.6	0.1	0.1	0.006	Low	\$ 180.00	\$ 225.00
	Raking beam	A5-2	A5-3	Spalling	W	1	0.1	0.3	0.03	Low	\$ 900.00	\$ 1,125.00	
	Transverse beam	A5-1	A5-2	Crack	E,W,B	3.2	0.25	0.1	0.08	High	\$ 2,400.00	\$ 3,000.00	
	Transverse beam	A5-2	A5-3	Crack	E,B	3.2	0.25	0.1	0.08	High	\$ 2,400.00	\$ 3,000.00	
	Intermediate beam	A5a-1	A5a-2	Spalling	E	1.5	0.1	0.1	0.015	High	\$ 450.00	\$ 562.50	
	Intermediate beam	A5a-1	A5a-2	Crack	B	3.2	0.1	0.1	0.032	High	\$ 960.00	\$ 1,200.00	
	Intermediate beam	A5a-2	A5a-3	Crack	E,W,B	3.2	0.1	0.25	0.08	High	\$ 2,400.00	\$ 3,000.00	
	Intermediate beam	A5b-1	A5b-2	Crack	B	3.2	0.1	0.1	0.032	High	\$ 960.00	\$ 1,200.00	
	Intermediate beam	A5b-2	A5b-3	Spalling	B	1.4	0.1	0.25	0.035	High	\$ 1,050.00	\$ 1,312.50	
	Intermediate beam	A5c-1	A5c-2	Crack	B	3.2	0.1	0.1	0.032	High	\$ 960.00	\$ 1,200.00	
	Intermediate beam	A5c-2	A5c-3	Crack	E,W,B	2.2	0.2	0.25	0.11	High	\$ 3,300.00	\$ 4,125.00	
	Slab	A5c-1	A6-2	Spalling	B	0.7	0.1	0.1	0.007	High	\$ 210.00	\$ 262.50	
1936 - Bay A6-A7	Pile	A6-1		Crack	W	1	0.1	0.1	0.01	High	\$ 300.00	\$ 375.00	
	Pile	A6-2		Crack	E,W	0.9	0.1	0.4	0.036	High	\$ 1,080.00	\$ 1,350.00	
	Pile	A6-2		Crack	S,E,N	0.8	0.1	0.4	0.032	High	\$ 960.00	\$ 1,200.00	
	Raking beam	A6-2	A6-3	Crack	E,T	2	0.1	0.1	0.02	Low	\$ 600.00	\$ 750.00	
	Raking beam	A6-2	A6-3	Spalling	W	1.2	0.1	0.1	0.012	Low	\$ 360.00	\$ 450.00	
	Transverse beam	A6-1	A6-2	Spalling	E	0.3	0.15	0.15	0.00675	High	\$ 202.50	\$ 253.13	
	Transverse beam	A6-1	A6-2	Crack	E,W,B	2.4	0.1	0.25	0.06	High	\$ 1,800.00	\$ 2,250.00	
	Transverse beam	A6-2	A6-3	Crack	E,W	3.2	0.1	0.25	0.08	High	\$ 2,400.00	\$ 3,000.00	
	Longitudinal beam	A6-3	A7-3	Crack	B	1	0.1	0.1	0.01	High	\$ 300.00	\$ 375.00	
	Intermediate beam	A6a-1	A6a-2	Crack	B	3.2	0.1	0.1	0.032	High	\$ 960.00	\$ 1,200.00	
	Intermediate beam	A6a-2	A6a-3	Crack	E,W	1.5	0.1	0.25	0.0375	High	\$ 1,125.00	\$ 1,406.25	
	Intermediate beam	A6b-1	A6b-2	Crack	B	0.7	0.1	0.1	0.007	High	\$ 210.00	\$ 262.50	
	Intermediate beam	A6b-1	A6b-2	Crack	B	0.9	0.1	0.1	0.009	High	\$ 270.00	\$ 337.50	
	Intermediate beam	A6b-2	A6b-3	Crack	E,W,B	2.5	0.1	0.25	0.0625	High	\$ 1,875.00	\$ 2,343.75	
	Intermediate beam	A6c-1	A6c-2	Crack	E	3.2	0.3	0.1	0.096	High	\$ 2,880.00	\$ 3,600.00	
	Intermediate beam	A6c-1	A6c-2	Crack	B	1.2	0.1	0.1	0.012	High	\$ 360.00	\$ 450.00	
Intermediate beam	A6c-1	A6c-2	Crack	B	1.2	0.1	0.1	0.012	High	\$ 360.00	\$ 450.00		
Intermediate beam	A6c-2	A6c-3	Crack	B	2.4	0.1	0.25	0.06	High	\$ 1,800.00	\$ 2,250.00		

Inspected 5th November 2014

Concrete repair cost / m3
\$ 30,000.00 \$ 37,500.00

Concrete repairs required

Section	Member description	Member location		Defect	Defect Location (North, South, East, West, Top, Bottom faces)	Repair dimensions estimate (assumes break out repair with sprayed concrete)					Estimated Costs	
		Start	Finish			Length (m)	Width (m)	Depth (m)	Volume (m3)	Priority	Baseline cost	Sensitivity
1936 - Bay A7-B1	Pile	A7-1		Crack	E	1.6	0.1	0.1	0.016	High	\$ 480.00	\$ 600.00
	Pile	A7-2		Crack	E	0.3	0.1	0.1	0.003	High	\$ 90.00	\$ 112.50
	Raking beam	A7-1	A7-2	Crack	W	1.5	0.1	0.1	0.015	Low	\$ 450.00	\$ 562.50
	Raking beam	A7-2	A7-3	Crack	E	1.8	0.1	0.2	0.036	Low	\$ 1,080.00	\$ 1,350.00
	Transverse beam	A7-2	A7-3	Crack	E	2.3	0.1	0.1	0.023	High	\$ 690.00	\$ 862.50
1940 - Bay B1-B2	Pile	B1-2		Crack	E	0.6	0.1	0.1	0.006	High	\$ 180.00	\$ 225.00
	Pile	B1-2		Crack	W	1	0.1	0.2	0.02	High	\$ 600.00	\$ 750.00
	Pile	B1-2		Crack	S	0.5	0.1	0.1	0.005	High	\$ 150.00	\$ 187.50
	Raking beam	B1-2	B1-3	Void	E	0.3	0.1	0.2	0.006	Low	\$ 180.00	\$ 225.00
	Raking beam	B1-2	B1-3	Void	W	0.2	0.1	0.2	0.004	Low	\$ 120.00	\$ 150.00
	Raking beam	B1-2	B1-3	Crack	W	0.7	0.1	0.1	0.007	Low	\$ 210.00	\$ 262.50
	Slab	B1b-1	B1c-2	Spalling	B	0.6	0.1	0.4	0.024	High	\$ 720.00	\$ 900.00
	Slab	B1c-2	B2-3	Spalling	B	0.6	0.1	0.4	0.024	High	\$ 720.00	\$ 900.00
	1940 - Bay B2-B3	Pile	B2-1		Crack	S	1	0.1	0.1	0.01	High	\$ 300.00
Pile		B2-1		Crack	S	1	0.1	0.1	0.01	High	\$ 300.00	\$ 375.00
Pile		B2-2		Crack	E	0.8	0.1	0.1	0.008	High	\$ 240.00	\$ 300.00
Raking beam		B2-2	B2-3	Crack	E	1	0.1	0.1	0.01	Low	\$ 300.00	\$ 375.00
Raking beam		B2-2	B2-3	Crack	E	0.6	0.1	0.1	0.006	Low	\$ 180.00	\$ 225.00
Transverse beam		B2-1	B2-2	Spalling	E,W	0.3	0.1	0.25	0.0075	High	\$ 225.00	\$ 281.25
Longitudinal beam		B2-1	B3-1	Spalling	N	4.3	0.1	0.1	0.043	High	\$ 1,290.00	\$ 1,612.50
1940 - Bay B3-B4		Pile	B3-2		Crack	E	0.6	0.1	0.1	0.006	High	\$ 180.00
	Pile	B3-2		Crack	W	0.2	0.1	0.1	0.002	High	\$ 60.00	\$ 75.00
	Raking beam	B3-2	B3-3	Crack	T	3.4	0.1	0.3	0.102	Low	\$ 3,060.00	\$ 3,825.00
	Raking beam	B3-2	B3-3	Void	E	1.2	0.1	0.2	0.024	Low	\$ 720.00	\$ 900.00
	Raking beam	B3-2	B3-3	Crack and Void	W	2.6	0.1	0.4	0.104	Low	\$ 3,120.00	\$ 3,900.00
	Longitudinal beam	B3-1	B4-1	Crack	N	1.2	0.1	0.1	0.012	High	\$ 360.00	\$ 450.00
	Longitudinal beam	B3-3	B4-3	Crack	S	1.2	0.1	0.1	0.012	High	\$ 360.00	\$ 450.00
	Longitudinal beam	B3-3	B4-3	Void	S	2.4	0.1	0.15	0.036	High	\$ 1,080.00	\$ 1,350.00
	1940 - Bay B4-B5	Pile	B4-2		Crack	W	0.5	0.1	0.1	0.005	High	\$ 150.00
Pile		B4-2		Void	W	0.65	0.1	0.35	0.02275	High	\$ 682.50	\$ 853.13
Raking beam		B4-2	B4-3	Void	E	1.6	0.1	0.25	0.04	Low	\$ 1,200.00	\$ 1,500.00
Raking beam		B4-2	B4-3	Void	E	0.4	0.1	0.25	0.01	Low	\$ 300.00	\$ 375.00
Raking beam		B4-2	B4-3	Void	B	0.8	0.1	0.3	0.024	Low	\$ 720.00	\$ 900.00
Raking beam		B4-2	B4-3	Void	W	1.4	0.1	0.25	0.035	Low	\$ 1,050.00	\$ 1,312.50
Longitudinal beam		B4-3	B5-3	Void	S	2	0.15	0.5	0.15	High	\$ 4,500.00	\$ 5,625.00
Intermediate beam		B4a-2	B4a-3	Spalling	B	1	0.1	0.2	0.02	High	\$ 600.00	\$ 750.00
Intermediate beam		B4b-2	B4b-3	Crack	B	1.6	0.1	0.1	0.016	High	\$ 480.00	\$ 600.00
Intermediate beam		B4c-2	B4c-3	Void	B	3.2	0.1	0.15	0.048	High	\$ 1,440.00	\$ 1,800.00
Slab		B4a-2	B4b-3	Void	B	0.2	0.1	0.2	0.004	High	\$ 120.00	\$ 150.00
Slab		B4b-2	B4c-3	Void	B	0.85	0.1	0.7	0.0595	High	\$ 1,785.00	\$ 2,231.25
1940 - Bay B5-B6		Pile	B5-2		Crack	E,W	1.4	0.1	0.4	0.056	High	\$ 1,680.00
	Raking beam	B5-2	B5-3	Void	E	1.4	0.1	0.2	0.028	Low	\$ 840.00	\$ 1,050.00
	Raking beam	B5-2	B5-3	Void	W	2.4	0.1	0.2	0.048	Low	\$ 1,440.00	\$ 1,800.00
	Transverse beam	B5-1	B5-2	Crack	E	0.5	0.1	0.1	0.005	High	\$ 150.00	\$ 187.50
	Transverse beam	B5-1	B5-2	Spalling	W	0.25	0.1	0.1	0.0025	High	\$ 75.00	\$ 93.75
	Longitudinal beam	B5-2	B5-3	Crack	B	0.8	0.1	0.1	0.008	High	\$ 240.00	\$ 300.00
	Slab	B5-1	B5a-2	Spalling	B	0.3	0.1	0.15	0.0045	High	\$ 135.00	\$ 168.75
	1940 - Bay B6-B7	Pile	B6-1		Crack	E	0.6	0.1	0.1	0.006	High	\$ 180.00
Pile		B6-1		Crack	E	1	0.1	0.1	0.01	High	\$ 300.00	\$ 375.00
Pile		B6-1		Crack	W	1.5	0.1	0.1	0.015	High	\$ 450.00	\$ 562.50
Pile		B6-2		Crack	E	0.6	0.1	0.1	0.006	High	\$ 180.00	\$ 225.00
Pile		B6-2		Crack	S	0.6	0.1	0.1	0.006	High	\$ 180.00	\$ 225.00
Pile		B6-2		Void	W	1	0.1	0.4	0.04	High	\$ 1,200.00	\$ 1,500.00
Raking beam		B6-2	B6-3	Spalling	E	1.2	0.1	0.2	0.024	Low	\$ 720.00	\$ 900.00
Raking beam		B6-2	B6-3	Void	E	1.3	0.1	0.35	0.0455	Low	\$ 1,365.00	\$ 1,706.25
Raking beam		B6-2	B6-3	Void	W	3.4	0.1	0.35	0.119	Low	\$ 3,570.00	\$ 4,462.50
Transverse beam		B6-1	B6-2	Spalling	E	0.8	0.1	0.15	0.012	High	\$ 360.00	\$ 450.00
Transverse beam		B6-2	B6-3	Spalling	W	0.7	0.1	0.1	0.007	High	\$ 210.00	\$ 262.50
Transverse beam		B6-1	B6-2	Spalling	B	1	0.1	0.2	0.02	High	\$ 600.00	\$ 750.00
Transverse beam		B6-1	B6-2	Spalling	B	0.6	0.1	0.2	0.012	High	\$ 360.00	\$ 450.00
Longitudinal beam		B6-1	B6-2	Spalling	B	0.6	0.1	0.15	0.009	High	\$ 270.00	\$ 337.50
Longitudinal beam		B6-1	B6-2	Spalling	B	0.8	0.1	0.15	0.012	High	\$ 360.00	\$ 450.00
Slab		B6-2	B6a-3	Crack	B	0.6	0.1	0.1	0.006	High	\$ 180.00	\$ 225.00
1940 - Bay B7-B8	Pile	B7-1		Crack	E	1.75	0.1	0.1	0.0175	High	\$ 525.00	\$ 656.25
	Pile	B7-1		Crack	W	1.6	0.1	0.1	0.016	High	\$ 480.00	\$ 600.00
	Pile	B7-1		Crack	S	1.5	0.1	0.1	0.015	High	\$ 450.00	\$ 562.50
	Pile	B7-2		Crack	E	0.4	0.1	0.1	0.004	High	\$ 120.00	\$ 150.00
	Raking beam	B7-2	B7-3	Void	E	1.4	0.1	0.2	0.028	Low	\$ 840.00	\$ 1,050.00
	Raking beam	B7-2	B7-3	Void	W	1.5	0.1	0.2	0.03	Low	\$ 900.00	\$ 1,125.00
	Raking beam	B7-2	B7-3	Crack	W	1.6	0.1	0.1	0.016	Low	\$ 480.00	\$ 600.00
	Transverse beam	B7-1	B7-2	Spalling	W	0.6	0.1	0.15	0.009	High	\$ 270.00	\$ 337.50
	Longitudinal beam	B7-3	B8-3	Spalling	S	0.75	0.1	0.2	0.015	High	\$ 450.00	\$ 562.50
	1940 - Bay B8-B9	Pile	B8-2		Crack	E	0.9	0.1	0.1	0.009	High	\$ 270.00
Pile		B8-2		Crack	W	1.7	0.1	0.1	0.017	High	\$ 510.00	\$ 637.50
Raking beam		B8-2	B8-3	Crack	W	0.6	0.1	0.1	0.006	Low	\$ 180.00	\$ 225.00
Raking beam		B8-2	B8-3	Crack	W	1.5	0.1	0.1	0.015	Low	\$ 450.00	\$ 562.50
Raking beam		B8-2	B8-3	Void	W	1.2	0.1	0.2	0.024	Low	\$ 720.00	\$ 900.00

Concrete repairs required

Section	Member description	Member location		Defect	Defect Location (North, South, East, West, Top, Bottom faces)	Repair dimensions estimate (assumes break out repair with sprayed concrete)					Estimated Costs	
		Start	Finish			Length (m)	Width (m)	Depth (m)	Volume (m3)	Priority	Baseline cost	Sensitivity
1940 - Bay B9-B10	Pile	B9-1		Crack	E	1.1	0.1	0.1	0.011	High	\$ 330.00	\$ 412.50
	Pile	B9-1		Crack	S	1.1	0.1	0.1	0.011	High	\$ 330.00	\$ 412.50
	Pile	B9-1		Spalling	W	1	0.1	0.1	0.01	High	\$ 300.00	\$ 375.00
	Pile	B9-1		Crack	W	0.8	0.1	0.1	0.008	High	\$ 240.00	\$ 300.00
	Pile	B9-2		Cracks	E	0.3	0.1	0.1	0.003	High	\$ 90.00	\$ 112.50
	Pile	B9-2		Crack	E	0.7	0.1	0.1	0.007	High	\$ 210.00	\$ 262.50
	Pile	B9-2		Void	W	0.45	0.1	0.28	0.0126	High	\$ 378.00	\$ 472.50
	Pile	B9-2		Crack	S	0.9	0.1	0.1	0.009	High	\$ 270.00	\$ 337.50
	Pile	B9-3		Crack	W	0.3	0.1	0.1	0.003	High	\$ 90.00	\$ 112.50
	Raking beam	B9-2	B9-3	Crack	T	0.8	0.1	0.1	0.008	Low	\$ 240.00	\$ 300.00
	1940 - Bay B10-B11	Pile	B10-2		Crack	S	1.1	0.1	0.1	0.011	High	\$ 330.00
Pile		B10-2		Cracks	W	0.8	0.1	0.45	0.036	High	\$ 1,080.00	\$ 1,350.00
Pile		B10-3		Crack	W	0.4	0.1	0.1	0.004	High	\$ 120.00	\$ 150.00
Raking beam		B10-2	B10-3	Void	E	1.3	0.1	0.2	0.026	Low	\$ 780.00	\$ 975.00
Raking beam		B10-2	B10-3	Crack	T	2.5	0.1	0.1	0.025	Low	\$ 750.00	\$ 937.50
Raking beam		B10-2	B10-3	Cracks	W	1.5	0.1	0.35	0.0525	Low	\$ 1,575.00	\$ 1,968.75
Longitudinal beam		B10-1	B11-1	Spalling	N	0.5	0.1	0.15	0.0075	High	\$ 225.00	\$ 281.25
Longitudinal beam		B10-2	B11-2	Spalling	S	0.4	0.1	0.15	0.006	High	\$ 180.00	\$ 225.00
1940 - Bay B11-B12	Pile	B11-2		Crack	E	0.6	0.1	0.1	0.006	High	\$ 180.00	\$ 225.00
	Pile	B11-2		Crack	E	0.7	0.1	0.1	0.007	High	\$ 210.00	\$ 262.50
	Pile	B11-2		Crack	W	1.1	0.1	0.1	0.011	High	\$ 330.00	\$ 412.50
	Raking beam	B11-2	B11-3	Crack and Spalling	E	2.6	0.1	0.1	0.026	Low	\$ 780.00	\$ 975.00
	Raking beam	B11-2	B11-3	Cracks	W	2.6	0.1	0.2	0.052	Low	\$ 1,560.00	\$ 1,950.00
	Longitudinal beam	B11-1	B12-1	Spalling	N	0.35	0.1	0.1	0.0035	High	\$ 105.00	\$ 131.25
1940 - Bay B12-B13	Pile	B12-2		Void	E	0.8	0.1	0.4	0.032	High	\$ 960.00	\$ 1,200.00
	Pile	B12-2		Void	N	0.7	0.1	0.2	0.014	High	\$ 420.00	\$ 525.00
	Pile	B12-3		Void	E	0.35	0.1	0.35	0.01225	High	\$ 367.50	\$ 459.38
	Pile	B12-3		Crack	W	0.3	0.1	0.1	0.003	High	\$ 90.00	\$ 112.50
	Raking beam	B12-2	B12-3	Void	E	2.9	0.1	0.3	0.087	Low	\$ 2,610.00	\$ 3,262.50
	Raking beam	B12-2	B12-3	Spalling	W,T	2.1	0.1	0.15	0.0315	Low	\$ 945.00	\$ 1,181.25
	Longitudinal beam	B12-2	B13-2	Crack	B	0.9	0.1	0.1	0.009	High	\$ 270.00	\$ 337.50
1940 - Bay B13-B14	Pile	B13-1		Cracks	N,W	1.2	0.1	0.1	0.012	High	\$ 360.00	\$ 450.00
	Pile	B13-2		Crack, Void and Spalling	E	0.7	0.1	0.4	0.028	High	\$ 840.00	\$ 1,050.00
	Pile	B13-2		Crack and Spalling	W	0.9	0.1	0.4	0.036	High	\$ 1,080.00	\$ 1,350.00
	Pile	B13-2		Crack	W	0.4	0.1	0.1	0.004	High	\$ 120.00	\$ 150.00
	Pile	B13-3		Void	W	0.35	0.1	0.25	0.00875	High	\$ 262.50	\$ 328.13
	Raking beam	B13-2	B13-3	Spalling	E	2.3	0.1	0.3	0.069	Low	\$ 2,070.00	\$ 2,587.50
	Raking beam	B13-2	B13-3	Crack	W	1.1	0.1	0.1	0.011	Low	\$ 330.00	\$ 412.50
	Raking beam	B13-2	B13-3	Crack	W	0.7	0.1	0.1	0.007	Low	\$ 210.00	\$ 262.50
	Raking beam	B13-2	B13-3	Spalling	W	0.7	0.1	0.15	0.0105	Low	\$ 315.00	\$ 393.75
	Longitudinal beam	B13-2	B14-2	Spalling	S	0.8	0.1	0.15	0.012	High	\$ 360.00	\$ 450.00
	Slab	B13c-1	B14-2	Spalling	B	0.4	0.1	0.2	0.008	High	\$ 240.00	\$ 300.00
1940 - Bay B14-B15	Pile	B14-1		Crack	S	1	0.1	0.1	0.01	High	\$ 300.00	\$ 375.00
	Pile	B14-2		Void, Crack	E	0.8	0.1	0.3	0.024	High	\$ 720.00	\$ 900.00
	Pile	B14-2		Void, Crack	W	1	0.1	0.45	0.045	High	\$ 1,350.00	\$ 1,687.50
	Pile	B14-2		Crack	W	0.6	0.1	0.1	0.006	High	\$ 180.00	\$ 225.00
	Raking beam	B14-2	B14-3	Void, Crack	E	1.8	0.1	0.2	0.036	Low	\$ 1,080.00	\$ 1,350.00
	Raking beam	B14-2	B14-3	Void	E	0.5	0.1	0.2	0.01	Low	\$ 300.00	\$ 375.00
	Raking beam	B14-2	B14-3	Crack	T	0.7	0.1	0.1	0.007	Low	\$ 210.00	\$ 262.50
	Raking beam	B14-2	B14-3	Void	W	2.5	0.1	0.25	0.0625	Low	\$ 1,875.00	\$ 2,343.75
	Longitudinal beam	B14-2	B15-2	Spalling	N,B	0.8	0.1	0.15	0.012	High	\$ 360.00	\$ 450.00
	Longitudinal beam	B14-2	B15-2	Crack	B	0.7	0.1	0.1	0.007	High	\$ 210.00	\$ 262.50
	Longitudinal beam	B14-3	B15-3	Void	N,B	1	0.1	0.1	0.01	High	\$ 300.00	\$ 375.00
Longitudinal beam	B14-3	B15-3	Spalling	N,B	0.8	0.1	0.2	0.016	High	\$ 480.00	\$ 600.00	
1940 - Bay B15-C1	Pile	B15-1		Crack	E	0.8	0.1	0.1	0.008	High	\$ 240.00	\$ 300.00
	Pile	B15-1		Crack	S	0.7	0.1	0.1	0.007	High	\$ 210.00	\$ 262.50
	Pile	B15-2		Crack	E	1.1	0.1	0.1	0.011	High	\$ 330.00	\$ 412.50
	Pile	B15-2		Crack	S	0.8	0.1	0.1	0.008	High	\$ 240.00	\$ 300.00
	Pile	B15-2		Crack	W	0.7	0.1	0.1	0.007	High	\$ 210.00	\$ 262.50
	Raking beam	B15-2	B15-3	Crack, Void	E	1.2	0.1	0.2	0.024	Low	\$ 720.00	\$ 900.00
	Raking beam	B15-2	B15-3	Crack	E	1	0.1	0.1	0.01	Low	\$ 300.00	\$ 375.00
Raking beam	B15-2	B15-3	Crack	W	1.8	0.1	0.1	0.018	Low	\$ 540.00	\$ 675.00	
1919 - Bay C1-C2	Raking beam	C1-2	C1-3	Crack	E	0.5	0.1	0.1	0.005	High	\$ 150.00	\$ 187.50
	Raking beam	C1-2	C1-3	Crack	E	0.4	0.1	0.1	0.004	High	\$ 120.00	\$ 150.00
	Intermediate beam	C1a-3	C1a-4	Void	B	1	0.1	0.1	0.01	High	\$ 300.00	\$ 375.00
	Intermediate beam	C1b-1	C1b-2	Spalling	E,B	3	0.1	0.1	0.03	High	\$ 900.00	\$ 1,125.00
	Intermediate beam	C1b-2	C1b-3	Void	E	0.7	0.1	0.1	0.007	High	\$ 210.00	\$ 262.50
	Intermediate beam	C1b-2	C1b-3	Void	W	1.8	0.1	0.1	0.018	High	\$ 540.00	\$ 675.00
	Intermediate beam	C1c-3	C1c-4	Crack	E	1.5	0.1	0.1	0.015	High	\$ 450.00	\$ 562.50
	Intermediate beam	C1c-3	C1c-4	Void	B	1.6	0.1	0.1	0.016	High	\$ 480.00	\$ 600.00
	Intermediate beam	C1c-3	C1c-4	Void	B	1.7	0.1	0.1	0.017	High	\$ 510.00	\$ 637.50
	Slab	C1-1	C1a-2	Crack	B	1	0.1	0.1	0.01	High	\$ 300.00	\$ 375.00
	Slab	C1-2	C1a-3	Spalling	B	0.4	0.1	0.2	0.008	High	\$ 240.00	\$ 300.00
	Slab	C1b-2	C1c-3	Spalling	B	0.3	0.1	0.2	0.006	High	\$ 180.00	\$ 225.00
	Slab	C1c-2	C2-3	Spalling	B	0.3	0.1	0.15	0.0045	High	\$ 135.00	\$ 168.75
1919 - Bay C2-C3	Pile	C2-3		Crack	S	0.3	0.1	0.1	0.003	High	\$ 90.00	\$ 112.50
	Pile	C2-3		Cracks	S,N	0.7	0.1	0.45	0.0315	High	\$ 945.00	\$ 1,181.25
	Raking beam	C2-2	C2-3	Spalling	E	0.3	0.1	0.4	0.012	High	\$ 360.00	\$ 450.00
	Raking beam	C2-2	C2-3	Crack	E	1.5	0.1	0.1	0.015	High	\$ 450.00	\$ 562.50
	Raking beam	C2-2	C2-3	Crack	E	0.7	0.1	0.1	0.007	High	\$ 210.00	\$ 262.50
	Raking beam	C2-2	C2-3	Crack	W	1	0.1	0.1	0.01	High	\$ 300.00	\$ 375.00
	Transverse beam	C2-3	C2-4	Cracks, Void	E,W,B	3.3	0.2	0.15	0.099	High	\$ 2,970.00	\$ 3,712.50
	Intermediate beam	C2a-3	C2a-4	Void	E,W,B	3	0.25	0.1	0.075	High	\$ 2,250.00	\$ 2,812.50
	Intermediate beam	C2b-3	C2b-4	Void	E,W,B	3	0.25	0.1	0.075	High	\$ 2,250.00	\$ 2,812.50

Concrete repairs required

Section	Member description	Member location		Defect	Defect Location (North, South, East, West, Top, Bottom faces)	Repair dimensions estimate (assumes break out repair with sprayed concrete)					Estimated Costs	
		Start	Finish			Length (m)	Width (m)	Depth (m)	Volume (m3)	Priority	Baseline cost	Sensitivity
	Intermediate beam	C2c-1	C2c-2	Spalling	B	0.5	0.2	0.1	0.01	High	\$ 300.00	\$ 375.00
	Intermediate beam	C2c-2	C2c-3	Spalling	B	0.6	0.15	0.1	0.009	High	\$ 270.00	\$ 337.50
	Intermediate beam	C2c-3	C2c-4	Spalling	B	0.7	0.25	0.1	0.0175	High	\$ 525.00	\$ 656.25
	Slab	C2a-2	C2b-3	Spalling	B	0.2	0.3	0.1	0.006	High	\$ 180.00	\$ 225.00
	Slab	C2b-3	C2c-4	Spalling	B	0.5	0.3	0.1	0.015	High	\$ 450.00	\$ 562.50
	Slab	C2b-3	C2c-4	Spalling	B	0.7	0.3	0.1	0.021	High	\$ 630.00	\$ 787.50
	Slab	C2b-3	C2c-4	Spalling	B	0.5	0.35	0.1	0.0175	High	\$ 525.00	\$ 656.25
	Slab	C2c-2	C3-3	Spalling	B	1.4	0.35	0.1	0.049	High	\$ 1,470.00	\$ 1,837.50
1919- Bay C3-C4	Pile	C3-3		Spalling	S	0.3	0.1	0.1	0.003	High	\$ 90.00	\$ 112.50
	Raking beam	C3-2	C3-3	Crack	E	0.6	0.1	0.1	0.006	High	\$ 180.00	\$ 225.00
	Raking beam	C3-2	C3-3	Void	W	1.5	0.2	0.1	0.03	High	\$ 900.00	\$ 1,125.00
	Transverse beam	C3-3	C3-4	Crack	E	1.3	0.1	0.1	0.013	High	\$ 390.00	\$ 487.50
	Transverse beam	C3-3	C3-4	Crack	B	1.5	0.1	0.1	0.015	High	\$ 450.00	\$ 562.50
	Transverse beam	C3-1	C3-2	Crack	B	1	0.1	0.1	0.01	High	\$ 300.00	\$ 375.00
	Intermediate beam	C3a-1	C3a-2	Crack	B	1	0.1	0.1	0.01	High	\$ 300.00	\$ 375.00
	Intermediate beam	C3a-2	C3a-3	Void	E,W,B	1.3	0.25	0.1	0.0325	High	\$ 975.00	\$ 1,218.75
	Intermediate beam	C3a-3	C3a-4	Void	E	2	0.1	0.1	0.02	High	\$ 600.00	\$ 750.00
	Intermediate beam	C3b-2	C3b-3	Crack	B	1.1	0.1	0.1	0.011	High	\$ 330.00	\$ 412.50
	Intermediate beam	C3b-3	C3b-4	Crack	B	1.3	0.25	0.1	0.0325	High	\$ 975.00	\$ 1,218.75
	Intermediate beam	C3c-3	C3c-4	Void	E,W,B	2.1	0.25	0.1	0.0525	High	\$ 1,575.00	\$ 1,968.75
	Slab	C3-2	C3a-3	Spalling	B	0.6	0.4	0.1	0.024	High	\$ 720.00	\$ 900.00
	Slab	C3-2	C3a-3	Spalling	B	1	0.3	0.1	0.03	High	\$ 900.00	\$ 1,125.00
	Slab	C3a-2	C3b-3	Spalling	B	2	0.5	0.1	0.1	High	\$ 3,000.00	\$ 3,750.00
	Slab	C3b-2	C3c-3	Spalling	B	0.4	0.4	0.1	0.016	High	\$ 480.00	\$ 600.00
	Slab	C3b-2	C3c-3	Spalling	B	0.7	0.4	0.1	0.028	High	\$ 840.00	\$ 1,050.00
	Slab	C3c-1	C4-2	Spalling	B	0.6	0.4	0.1	0.024	High	\$ 720.00	\$ 900.00
	Slab	C3c-2	C4-3	Void	B	1.1	0.4	0.1	0.044	High	\$ 1,320.00	\$ 1,650.00
	Slab	C3c-3	C4-4	Void	B	0.5	0.1	0.1	0.005	High	\$ 150.00	\$ 187.50
1919- Bay C4-C5	Pile	C4-3		Crack	E	0.5	0.1	0.1	0.005	High	\$ 150.00	\$ 187.50
	Raking beam	C4-2	C4-3	Crack	E	0.9	0.1	0.1	0.009	High	\$ 270.00	\$ 337.50
	Raking beam	C4-2	C4-3	Crack	W	0.4	0.1	0.1	0.004	High	\$ 120.00	\$ 150.00
	Transverse beam	C4-1	C4-2	Crack	W	0.8	0.1	0.1	0.008	High	\$ 240.00	\$ 300.00
	Transverse beam	C4-2	C4-3	Crack	B	1.3	0.1	0.1	0.013	High	\$ 390.00	\$ 487.50
	Transverse beam	C4-3	C4-4	Void	B	1.4	0.25	0.1	0.035	High	\$ 1,050.00	\$ 1,312.50
	Transverse beam	C4-3	C4-4	Crack	W	0.8	0.1	0.1	0.008	High	\$ 240.00	\$ 300.00
	Longitudinal beam	C4-2	C5-2	Crack	B	4.5	0.1	0.1	0.045	High	\$ 1,350.00	\$ 1,687.50
	Intermediate beam	C4a-1	C4a-2	Spalling	B	2.1	0.1	0.1	0.021	High	\$ 630.00	\$ 787.50
	Intermediate beam	C4b-3	C4b-4	Crack	B	1.4	0.1	0.1	0.014	High	\$ 420.00	\$ 525.00
	Intermediate beam	C4c-3	C4c-4	Crack	B	1.8	0.1	0.1	0.018	High	\$ 540.00	\$ 675.00
	Slab	C4-1	C4a-2	Spalling	B	0.2	0.1	0.1	0.002	High	\$ 60.00	\$ 75.00
	Slab	C4-1	C4a-2	Spalling	B	0.2	0.1	0.1	0.002	High	\$ 60.00	\$ 75.00
	Slab	C4-2	C4a-3	Spalling	B	0.6	0.25	0.1	0.015	High	\$ 450.00	\$ 562.50
	Slab	C4-2	C4a-3	Spalling	B	0.6	0.3	0.1	0.018	High	\$ 540.00	\$ 675.00
	Slab	C4-3	C4a-4	Void	B	1.4	0.15	0.1	0.021	High	\$ 630.00	\$ 787.50
	Slab	C4a-1	C4b-2	Spalling	B	0.2	0.1	0.1	0.002	High	\$ 60.00	\$ 75.00
	Slab	C4a-1	C4b-2	Crack	B	0.4	0.1	0.1	0.004	High	\$ 120.00	\$ 150.00
	Slab	C4a-2	C4b-3	Spalling	B	0.3	0.2	0.1	0.006	High	\$ 180.00	\$ 225.00
	Slab	C4b-1	C4c-2	Spalling	B	2	0.75	0.1	0.15	High	\$ 4,500.00	\$ 5,625.00
	Slab	C4c-1	C5-2	Spalling	B	1.7	0.75	0.1	0.1275	High	\$ 3,825.00	\$ 4,781.25
1919- Bay C5-C6	Pile	C5-2		Crack	E,S	0.5	0.4	0.1	0.02	High	\$ 600.00	\$ 750.00
	Pile	C5-4		Spalling	N	0.3	0.3	0.1	0.009	High	\$ 270.00	\$ 337.50
	Raking beam	C5-1	C5-2	Crack	W	1.7	0.1	0.1	0.017	High	\$ 510.00	\$ 637.50
	Raking beam	C5-2	C5-3	Crack	T	2.8	0.1	0.1	0.028	High	\$ 840.00	\$ 1,050.00
	Raking beam	C5-2	C5-3	Crack	E	1.5	0.1	0.1	0.015	High	\$ 450.00	\$ 562.50
	Raking beam	C5-2	C5-3	Crack	W	3	0.1	0.1	0.03	High	\$ 900.00	\$ 1,125.00
	Transverse beam	C5-3	C5-4	Crack	E	1.2	0.1	0.1	0.012	High	\$ 360.00	\$ 450.00
	Transverse beam	C5-3	C5-4	Crack	B	1.2	0.1	0.1	0.012	High	\$ 360.00	\$ 450.00
	Longitudinal beam	C5-2	C6-2	Crack	B	2.4	0.1	0.1	0.024	High	\$ 720.00	\$ 900.00
	Longitudinal beam	C5-3	C6-3	Crack	B	3.2	0.1	0.1	0.032	High	\$ 960.00	\$ 1,200.00
	Intermediate beam	C5a-1	C5a-2	Crack	B	1	0.1	0.1	0.01	High	\$ 300.00	\$ 375.00
	Intermediate beam	C5a-3	C5a-4	Crack	B	1.7	0.1	0.1	0.017	High	\$ 510.00	\$ 637.50
	Intermediate beam	C5b-3	C5b-4	Crack	B	2.9	0.1	0.1	0.029	High	\$ 870.00	\$ 1,087.50
	Intermediate beam	C5c-3	C5c-4	Cracks	B	3.2	0.25	0.1	0.08	High	\$ 2,400.00	\$ 3,000.00
	Slab	C5-2	C5b-3	Crack	B	2.7	0.1	0.1	0.027	High	\$ 810.00	\$ 1,012.50
	Slab	C5a-1	C5b-2	Spalling	B	2.2	0.7	0.1	0.154	High	\$ 4,620.00	\$ 5,775.00
	Slab	C5b-2	C5c-3	Spalling	B	0.7	0.6	0.1	0.042	High	\$ 1,260.00	\$ 1,575.00
	Slab	C5c-2	C6-3	Spalling	B	0.7	0.6	0.1	0.042	High	\$ 1,260.00	\$ 1,575.00
	Slab	C5c-3	C6-4	Spalling	B	0.7	0.4	0.1	0.028	High	\$ 840.00	\$ 1,050.00
	Slab	C5c-3	C6-4	Spalling	B	0.5	0.4	0.1	0.02	High	\$ 600.00	\$ 750.00
1919- Bay C6-C7	Pile	C6-3		Crack	E	1	0.1	0.1	0.01	High	\$ 300.00	\$ 375.00
	Pile	C6-3		Void	W	1.1	0.3	0.1	0.033	High	\$ 990.00	\$ 1,237.50
	Raking beam	C6-2	C6-3	Void	E	2	0.2	0.3	0.12	High	\$ 3,600.00	\$ 4,500.00
	Raking beam	C6-2	C6-3	Spalling	W	1.3	0.15	0.3	0.0585	High	\$ 1,755.00	\$ 2,193.75
	Transverse beam	C6-1	C6-2	Crack	E	2.4	0.1	0.1	0.024	High	\$ 720.00	\$ 900.00
	Transverse beam	C6-1	C6-2	Crack	W	0.3	0.1	0.1	0.003	High	\$ 90.00	\$ 112.50
	Transverse beam	C6-3	C6-4	Cracking, Spalling	E	2.9	0.2	0.3	0.174	High	\$ 5,220.00	\$ 6,525.00
	Transverse beam	C6-3	C6-4	Void, Spalling	W	2.1	0.25	0.1	0.0525	High	\$ 1,575.00	\$ 1,968.75
	Transverse beam	C6-3	C6-4	Spalling	B	0.9	0.1	0.2	0.018	High	\$ 540.00	\$ 675.00
	Longitudinal beam	C6-2	C7-2	Crack	B	2.2	0.1	0.1	0.022	High	\$ 660.00	\$ 825.00
	Longitudinal beam	C6-2	C7-2	Crack	B	1.1	0.1	0.1	0.011	High	\$ 330.00	\$ 412.50
	Longitudinal beam	C6-3	C7-3	Crack	B	3.2	0.1	0.1	0.032	High	\$ 960.00	\$ 1,200.00
	Intermediate beam	C6b-2	C6b-3	Spalling	B	2.5	0.1	0.1	0.025	High	\$ 750.00	\$ 937.50
	Intermediate beam	C6b-3	C6b-4	Crack	B	2.8	0.1	0.1	0.028	High	\$ 840.00	\$ 1,050.00
	Intermediate beam	C6b-3	C6b-4	Spalling	B	0.5	0.1	0.1	0.005	High	\$ 150.00	\$ 187.50
	Intermediate beam	C6c-3	C6c-4	Crack	B	2.3	0.25	0.1	0.0575	High	\$ 1,725.00	\$ 2,156.25
	Slab	C6-1	C6a-2	Spalling	B	0.6	0.4	0.1	0.024	High	\$ 720.00	\$ 900.00
	Slab	C6a-1	C6b-2	Crack	B	2.3	0.1	0.1	0.023	High	\$ 690.00	\$ 862.50
	Slab	C6b-1	C6c-2	Crack	B	0.9	0.1	0.1	0.009	High	\$ 270.00	\$ 337.50
	Slab	C6b-1	C6c-2	Void	B	0.9	0.55	0.1	0.0495	High	\$ 1,485.00	\$ 1,856.25
	Slab	C6b-3	C6c-4	Crack	B	1.3	0.1	0.1	0.013	High	\$ 390.00	\$ 487.50

Concrete repairs required

Section	Member description	Member location		Defect	Defect Location (North, South, East, West, Top, Bottom faces)	Repair dimensions estimate (assumes break out repair with sprayed concrete)					Estimated Costs	
		Start	Finish			Length (m)	Width (m)	Depth (m)	Volume (m3)	Priority	Baseline cost	Sensitivity
1919- Bay C7-C8	Pile	C7-1		Spalling	E	0.8	0.15	0.1	0.012	High	\$ 360.00	\$ 450.00
	Pile	C7-3		Crack	W	1	0.1	0.1	0.01	High	\$ 300.00	\$ 375.00
	Raking beam	C7-2	C7-3	Void	E	0.3	0.2	0.1	0.006	High	\$ 180.00	\$ 225.00
	Raking beam	C7-2	C7-3	Void	W	1.5	0.2	0.1	0.03	High	\$ 900.00	\$ 1,125.00
	Raking beam	C7-2	C7-3	Crack	E	0.7	0.1	0.1	0.007	High	\$ 210.00	\$ 262.50
	Transverse beam	C7-3	C7-4	Crack	E	1.1	0.1	0.1	0.011	High	\$ 330.00	\$ 412.50
	Longitudinal beam	C7-2	C8-2	Crack	B	2.4	0.1	0.1	0.024	High	\$ 720.00	\$ 900.00
	Intermediate beam	C7a-1	C7a-2	Spalling	B	1.4	0.15	0.1	0.021	High	\$ 630.00	\$ 787.50
	Intermediate beam	C7b-2	C7b-3	Crack	B	2.9	0.1	0.1	0.029	High	\$ 870.00	\$ 1,087.50
	Intermediate beam	C7c-1	C7c-2	Crack	B	1.6	0.1	0.1	0.016	High	\$ 480.00	\$ 600.00
	Intermediate beam	C7c-1	C7c-2	Spalling	B	1.6	0.1	0.1	0.016	High	\$ 480.00	\$ 600.00
	Slab	C7-1	C7a-2	Crack	B	2	0.1	0.1	0.02	High	\$ 600.00	\$ 750.00
	Slab	C7-2	C7a-3	Crack	B	3	0.1	0.1	0.03	High	\$ 900.00	\$ 1,125.00
	Slab	C7-1	C7b-2	Crack	B	2	0.1	0.1	0.02	High	\$ 600.00	\$ 750.00
	Slab	C7a-2	C7b-3	Crack	B	2.5	0.1	0.1	0.025	High	\$ 750.00	\$ 937.50
	Slab	C7c-1	C8-2	Spalling	B	0.35	0.35	0.1	0.01225	High	\$ 367.50	\$ 459.38
	Slab	C7c-1	C8-2	Spalling	B	0.7	0.35	0.1	0.0245	High	\$ 735.00	\$ 918.75
Slab	C7c-3	C8-4	Spalling	B	0.45	0.5	0.1	0.0225	High	\$ 675.00	\$ 843.75	
1919- Bay C8-C9	Pile	C8-2		Spalling	E	0.7	0.1	0.1	0.007	High	\$ 210.00	\$ 262.50
	Pile	C8-3		Crack	E	1	0.1	0.1	0.01	High	\$ 300.00	\$ 375.00
	Pile	C8-3		Spalling	W	0.5	0.1	0.1	0.005	High	\$ 150.00	\$ 187.50
	Pile	C8-4		Crack	E	0.4	0.1	0.1	0.004	High	\$ 120.00	\$ 150.00
	Pile	C8-4		Cracks	E,W	0.9	0.1	0.1	0.009	High	\$ 270.00	\$ 337.50
	Raking beam	C8-2	C8-3	Spalling	E	2.5	0.3	0.1	0.075	High	\$ 2,250.00	\$ 2,812.50
	Raking beam	C8-2	C8-3	Spalling	W	0.7	0.1	0.1	0.007	High	\$ 210.00	\$ 262.50
	Raking beam	C8-2	C8-3	Crack	W	0.6	0.1	0.1	0.006	High	\$ 180.00	\$ 225.00
	Transverse beam	C8-2	C8-3	Crack	E	0.3	0.1	0.1	0.003	High	\$ 90.00	\$ 112.50
	Transverse beam	C8-2	C8-3	Crack	E	0.3	0.1	0.1	0.003	High	\$ 90.00	\$ 112.50
	Transverse beam	C8-2	C8-3	Crack	E,B	3	0.3	0.1	0.09	High	\$ 2,700.00	\$ 3,375.00
	Transverse beam	C8-3	C8-4	Crack	E	2.8	0.1	0.1	0.028	High	\$ 840.00	\$ 1,050.00
	Longitudinal beam	C8-3	C9-3	Crack	N,B	2.3	0.1	0.1	0.023	High	\$ 690.00	\$ 862.50
	Longitudinal beam	C8-3	C9-3	Spalling	S,B	1	0.1	0.1	0.01	High	\$ 300.00	\$ 375.00
	Intermediate beam	C8a-1	C8a-2	Spalling	B	0.6	0.1	0.1	0.006	High	\$ 180.00	\$ 225.00
	Intermediate beam	C8a-1	C8a-2	Crack	B	1.2	0.1	0.1	0.012	High	\$ 360.00	\$ 450.00
	Intermediate beam	C8a-2	C8a-3	Crack	B	1.4	0.1	0.1	0.014	High	\$ 420.00	\$ 525.00
	Intermediate beam	C8a-3	C8a-4	Cracks	B	2.5	0.25	0.1	0.0625	High	\$ 1,875.00	\$ 2,343.75
	Intermediate beam	C8b-1	C8b-2	Crack	B	3	0.1	0.1	0.03	High	\$ 900.00	\$ 1,125.00
	Intermediate beam	C8b-1	C8b-2	Spalling	B	1.2	0.25	0.1	0.03	High	\$ 900.00	\$ 1,125.00
	Intermediate beam	C8b-2	C8b-3	Crack	B	1.8	0.1	0.1	0.018	High	\$ 540.00	\$ 675.00
	Intermediate beam	C8b-3	C8b-4	Crack	B	2	0.1	0.1	0.02	High	\$ 600.00	\$ 750.00
	Intermediate beam	C8c-1	C8b-2	Crack	B	2.8	0.1	0.1	0.028	High	\$ 840.00	\$ 1,050.00
	Intermediate beam	C8c-1	C8b-2	Spalling	B	1	0.15	0.1	0.015	High	\$ 450.00	\$ 562.50
	Slab	C8-1	C8a-2	Spalling	B	1.6	0.5	0.1	0.08	High	\$ 2,400.00	\$ 3,000.00
	Slab	C8-2	C8a-3	Spalling	B	0.6	0.6	0.1	0.036	High	\$ 1,080.00	\$ 1,350.00
	Slab	C8-3	C8a-4	Spalling	B	0.5	0.5	0.1	0.025	High	\$ 750.00	\$ 937.50
	Slab	C8a-1	C8b-2	Crack	B	2.2	0.1	0.1	0.022	High	\$ 660.00	\$ 825.00
	Slab	C8a-1	C8b-2	Spalling	B	1.6	0.35	0.1	0.056	High	\$ 1,680.00	\$ 2,100.00
	Slab	C8a-2	C8b-3	Spalling	B	0.2	0.45	0.1	0.009	High	\$ 270.00	\$ 337.50
	Slab	C8a-3	C8b-4	Cracking & Spalling	B	0.3	0.37	0.1	0.0111	High	\$ 333.00	\$ 416.25
	Slab	C8b-1	C8b-2	Spalling	B	1.2	0.4	0.1	0.048	High	\$ 1,440.00	\$ 1,800.00
	Slab	C8b-2	C8b-3	Crack	B	0.5	0.1	0.1	0.005	High	\$ 150.00	\$ 187.50
	Slab	C8b-3	C8b-4	Spalling	B	0.3	0.3	0.1	0.009	High	\$ 270.00	\$ 337.50
	Slab	C8b-3	C8b-4	Crack	B	1	0.1	0.1	0.01	High	\$ 300.00	\$ 375.00
	Slab	C8c-1	C9-2	Spalling	B	1.2	0.4	0.1	0.048	High	\$ 1,440.00	\$ 1,800.00
Slab	C8c-2	C9-3	Spalling	B	0.3	0.15	0.1	0.0045	High	\$ 135.00	\$ 168.75	
Slab	C8c-3	C9-4	Spalling	B	0.7	0.5	0.1	0.035	High	\$ 1,050.00	\$ 1,312.50	
1919- Bay C9	Pile	C9-4		Crack	E	0.7	0.1	0.1	0.007	High	\$ 210.00	\$ 262.50
	Raking beam	C9-2	C9-3	Spalling	E	1.4	0.25	0.1	0.035	High	\$ 1,050.00	\$ 1,312.50
	Transverse beam	C9-2	C9-3	Crack	E	2.2	0.1	0.1	0.022	High	\$ 660.00	\$ 825.00
	Transverse beam	C9-3	C9-4	Void	E	1.2	0.35	0.1	0.042	High	\$ 1,260.00	\$ 1,575.00
	Transverse beam	C9-3	C9-4	Spalling	W	0.3	0.3	0.1	0.009	High	\$ 270.00	\$ 337.50
TOTAL										\$336,189.30	\$420,236.63	
Repair volume (2009-2014 defects)									2.12 m3			
Repair volume (pre-2009 defects)									9.08 m3			
Total repair volume									11.21 m3			

	Base value	Sensitivity
Total high priority repairs	\$280,455.30	\$350,569.13
Allow for reinforcing steel replacement (Provisional estimate)	\$40,000.00	\$50,000.00
P&G 30%	\$96,136.59	\$120,170.74
plus waterproof membrane	\$190,000.00	\$310,000.00
Contingency 50%	\$303,295.95	\$415,369.93
Total (High priority)	\$909,887.84	\$1,246,109.79
Total low priority repairs	\$55,734.00	\$69,667.50
Allow for reinforcing steel replacement (Provisional estimate)	\$10,000.00	\$15,000.00
P&G 30%	\$19,720.20	\$25,400.25
Contingency 50%	\$42,727.10	\$55,033.88
Total (Low priority)	\$128,181.30	\$165,101.63
Total all repair	\$336,189.30	\$420,236.63
Allow for reinforcing steel replacement (Provisional estimate)	\$50,000.00	\$65,000.00
P&G 30%	\$115,856.79	\$145,570.99
plus waterproof membrane	\$190,000.00	\$310,000.00
Contingency 50%	\$346,023.05	\$470,403.81
Total	\$1,038,069.14	\$1,411,211.42